

# **cdma2000 Guide**

## **Agilent Technologies PSA Series and VSA E4406A**

### **Option B78**

**This manual provides documentation for the following instruments:**

**Transmitter Tester:  
E4406A**

**Spectrum Analyzers:  
E4440A (3 Hz - 26.5 GHz)  
E4443A (3 Hz - 6.7 GHz)  
E4445A (3 Hz - 13.2 GHz)  
E4446A (3 Hz - 44.0 GHz)  
E4448A (3 Hz - 50.0 GHz)**



**Manufacturing Part Number: E4406-90239  
Supersedes E4440-90114 and E4406-90172**

**Printed in USA**

**December 2002**

© Copyright 1999 - 2002 Agilent Technologies, Inc.

The information contained in this document is subject to change without notice.

Agilent Technologies makes no warranty of any kind with regard to this material, including but not limited to, the implied warranties of merchantability and fitness for a particular purpose. Agilent Technologies shall not be liable for errors contained herein or for incidental or consequential damages in connection with the furnishing, performance, or use of this material.

<b>1. Understanding cdma2000</b>	
What Is the cdma2000 Communication System? .....	28
What Does the Agilent PSA Series and VSA E4406A Option B78 Do? .....	30
Other Sources of Measurement Information .....	31
<b>2. Getting Started</b>	
Instrument Front Panel Highlights .....	34
Making a Measurement .....	37
Start Making Channel Power Measurements .....	38
Start Making ACPR Measurements .....	41
Start Making Intermodulation Measurements .....	45
Start Making Spectrum Emission Mask Measurements .....	48
Start Making Occupied Bandwidth Measurements .....	51
Start Making Code Domain Measurements .....	54
Start Making Modulation Accuracy (Composite Rho) Measurements .....	59
Start Making QPSK EVM Measurements .....	63
Start Making Power Stat CCDF Measurements .....	67
If You Have a Problem .....	70
<b>3. Setting Up the Mode</b>	
cdma2000 Mode .....	74
cdma2000 Measurement Key Flow .....	85
Using Basic Mode on PSA Series .....	113
Installing Optional Measurement Personalities .....	114
<b>4. Making Measurements</b>	
cdma2000 Measurements .....	122
Preparing for Measurements .....	123
Making the Channel Power Measurement .....	130
Making the Adjacent Channel Power Ratio (ACPR) Measurement .....	135
Making the Intermodulation Measurement .....	145
Making the Spectrum Emission Mask Measurement .....	151
Making the Occupied Bandwidth Measurement .....	165
Making the Code Domain Measurement .....	170
Making the Modulation Accuracy (Composite Rho) Measurement .....	186
Making the QPSK EVM Measurement .....	198
Making the Power Stat CCDF Measurement .....	207
Making the Spectrum (Frequency Domain) Measurement .....	212
Making the Waveform (Time Domain) Measurement .....	225
Using Option B7C Baseband I/Q Inputs .....	238
<b>5. Programming Commands</b>	
SCPI Command Subsystems .....	264
Programming Command Compatibility Across Model Numbers and Across Modes .....	265
CALCulate Subsystem .....	270
CONFigure Subsystem .....	298

---

# Contents

DISPlay Subsystem . . . . .	.299
FETCh Subsystem . . . . .	.309
FORMat Subsystem . . . . .	.310
INITiate Subsystem . . . . .	.312
INSTrument Subsystem . . . . .	.315
MEASure Group of Commands . . . . .	.318
READ Subsystem . . . . .	.377
SENSE Subsystem . . . . .	.378
TRIGger Subsystem . . . . .	.479

# List of Commands

:CALCulate:CDPower:ASET:THReshold <numeric> . . . . .	270
:CALCulate:CDPower:ASET:THReshold:AUTO OFF   ON   0   1 . . . . .	270
:CALCulate:CDPower:ASET:THReshold:AUTO? . . . . .	270
:CALCulate:CDPower:ASET:THReshold? . . . . .	270
:CALCulate:CDPower:AXIS[:MS] IPH   QPH . . . . .	271
:CALCulate:CDPower:AXIS[:MS]? . . . . .	271
:CALCulate:CDPower:PNOFfset <time>. . . . .	271
:CALCulate:CDPower:PNOFfset? . . . . .	271
:CALCulate:CDPower:SWEep:OFFSet <integer>. . . . .	271
:CALCulate:CDPower:SWEep:OFFSet? . . . . .	271
:CALCulate:CDPower:SWEep:TIME <integer> . . . . .	272
:CALCulate:CDPower:SWEep:TIME? . . . . .	272
:CALCulate:CDPower:TYPE ABSolute   RELative . . . . .	273
:CALCulate:CDPower:TYPE? . . . . .	273
:CALCulate:CDPower:WCODe:BASE <integer> . . . . .	273
:CALCulate:CDPower:WCODe:BASE? . . . . .	273
:CALCulate:CDPower:WCODe:LENGth <integer> . . . . .	273
:CALCulate:CDPower:WCODe:LENGth? . . . . .	273
:CALCulate:CDPower:WCODe:ORDer BREVerse   . . . . .	274
:CALCulate:CDPower:WCODe:ORDer? . . . . .	274
:CALCulate:CDPower:WCODe[:NUMBer] <integer>. . . . .	274
:CALCulate:CDPower:WCODe[:NUMBer]? . . . . .	274
:CALCulate:CLIMits:FAIL? . . . . .	275
:CALCulate:DATA<n>:COMPress? BLOCk   CFIT   MAXimum   MEAN   MINimum   RMS   SAM- Ple   SDEViation [,<soffset>[,<length>[,<roffset>[,<rlimit>]]]] . . . . .	275
:CALCulate:DATA<n>:PEAKs? <threshold>,<excursion>[,<AMPLitude   FREQuency   TIME] . . . . .	282
:CALCulate:DATA[n]? . . . . .	275
:CALCulate:OBW:LIMit:FBLimit <freq> . . . . .	293
:CALCulate:OBW:LIMit:FBLimit? . . . . .	293
:CALCulate:OBW:LIMit[:TEST] OFF   ON   0   1 . . . . .	294
:CALCulate:OBW:LIMit[:TEST]? . . . . .	294

---

# List of Commands

:CALCulate:PStatistic:StORe:REfERence ON   1	294
:CALCulate:RHO:ASET:THReshold <numeric>	294
:CALCulate:RHO:ASET:THReshold:AUTO OFF   ON   0   1	295
:CALCulate:RHO:ASET:THReshold:AUTO?	295
:CALCulate:RHO:ASET:THReshold?	294
:CALCulate:RHO:LIMit:CDERror <float>	295
:CALCulate:RHO:LIMit:CDERror?	295
:CALCulate:RHO:LIMit:PEAK <float>	295
:CALCulate:RHO:LIMit:PEAK?	295
:CALCulate:RHO:LIMit:PHASe <float>	296
:CALCulate:RHO:LIMit:PHASe?	296
:CALCulate:RHO:LIMit:RHO <float>	296
:CALCulate:RHO:LIMit:RHO?	296
:CALCulate:RHO:LIMit:RMS <float>	296
:CALCulate:RHO:LIMit:RMS?	296
:CALCulate:RHO:LIMit:TIMing <float>	296
:CALCulate:RHO:LIMit:TIMing?	296
:CALCulate:RHO:PNOFfset <time>	297
:CALCulate:RHO:PNOFfset?	297
:CALCulate:<measurement>:MARKer:AOFF	285
:CALCulate:<measurement>:MARKer[1]   2   3   4:FUNCTion:RESult?	285
:CALCulate:<measurement>:MARKer[1]   2   3   4:MAXimum	286
:CALCulate:<measurement>:MARKer[1]   2   3   4:MINimum	286
:CALCulate:<measurement>:MARKer[1]   2   3   4:MODE POSition   DELTa	287
:CALCulate:<measurement>:MARKer[1]   2   3   4:MODE POSition   DELTa   RMSDeegree   RMSRadi-an   RFM   RMSJitter   OFF	287
:CALCulate:<measurement>:MARKer[1]   2   3   4:MODE?	287
:CALCulate:<measurement>:MARKer[1]   2   3   4:TRACe <trace_name>	288
:CALCulate:<measurement>:MARKer[1]   2   3   4:TRACe?	288
:CALCulate:<measurement>:MARKer[1]   2   3   4:X <param>	292
:CALCulate:<measurement>:MARKer[1]   2   3   4:X:POSition <integer>	292

---

# List of Commands

:CALCulate:<measurement>:MARKer[1]   2   3   4:X:POSition? . . . . .	292
:CALCulate:<measurement>:MARKer[1]   2   3   4:X? . . . . .	292
:CALCulate:<measurement>:MARKer[1]   2   3   4:Y? . . . . .	293
:CALCulate:<measurement>:MARKer[1]   2   3   4[:STATe] OFF   ON   0   1 . . . . .	287
:CALCulate:<measurement>:MARKer[1]   2   3   4[:STATe]? . . . . .	287
:CONFigure:ACP . . . . .	322
:CONFigure:CDPower . . . . .	328
:CONFigure:CHPower . . . . .	341
:CONFigure:EVMQpsk . . . . .	342
:CONFigure:IM . . . . .	345
:CONFigure:OBW . . . . .	348
:CONFigure:PStatistic . . . . .	349
:CONFigure:RHO . . . . .	351
:CONFigure:SEMask . . . . .	366
:CONFigure:SPECtrum . . . . .	372
:CONFigure:WAVEform . . . . .	375
:CONFigure:<measurement> . . . . .	298
:CONFigure? . . . . .	298
:DISPlay:ACP:VIEW BGRaph   SPECtrum . . . . .	299
:DISPlay:ACP:VIEW? . . . . .	299
:DISPlay:CDPower:BCLength 64   128 . . . . .	299
:DISPlay:CDPower:BCLength? . . . . .	299
:DISPlay:FORMat:TILE . . . . .	299
:DISPlay:FORMat:ZOOM . . . . .	300
:DISPlay:RHO:VIEW ERRor   POLar   QUAD   TABLE   TPHase . . . . .	300
:DISPlay:RHO:VIEW POLar   ERRor . . . . .	300
:DISPlay:RHO:VIEW? . . . . .	300
:DISPlay:SPECtrum[n]:WINDow[m]:TRACe:Y[:SCALE]:PDIVision <power> . . . . .	301
:DISPlay:SPECtrum[n]:WINDow[m]:TRACe:Y[:SCALE]:PDIVision? . . . . .	301
:DISPlay:SPECtrum[n]:WINDow[m]:TRACe:Y[:SCALE]:RLEVel <power> . . . . .	302
:DISPlay:SPECtrum[n]:WINDow[m]:TRACe:Y[:SCALE]:RLEVel? . . . . .	302

---

# List of Commands

:DISPlay:TRACe[n][:STATe] OFF   ON   0   1 . . . . .	.302
:DISPlay:TRACe[n][:STATe]? . . . . .	.302
:DISPlay:WAVeform[n]:WINDow[m]:TRACe:Y[:SCALe]:PDIVision <power> . . . . .	.307
:DISPlay:WAVeform[n]:WINDow[m]:TRACe:Y[:SCALe]:PDIVision? . . . . .	.307
:DISPlay:WAVeform[n]:WINDow[m]:TRACe:Y[:SCALe]:RLEVel <power> . . . . .	.308
:DISPlay:WAVeform[n]:WINDow[m]:TRACe:Y[:SCALe]:RLEVel? . . . . .	.308
:FETCh:ACP[n]? . . . . .	.322
:FETCh:CDPower[n]? . . . . .	.328
:FETCh:CHPower[n]? . . . . .	.341
:FETCh:EVMQpsk[n]? . . . . .	.342
:FETCh:IM[n]? . . . . .	.345
:FETCh:OBW[n]? . . . . .	.348
:FETCh:PStatistic[n]? . . . . .	.349
:FETCh:RHO[n]? . . . . .	.351
:FETCh:SEMask[n]? . . . . .	.366
:FETCh:SPECTrum[n]? . . . . .	.372
:FETCh:WAVeform[n]? . . . . .	.375
:FETCh:<measurement>[n]? . . . . .	.309
:FORMat:BORDER NORMAL   SWAPped . . . . .	.310
:FORMat:BORDER? . . . . .	.310
:FORMat[:DATA] ASCii   REAL,32   REAL,64 . . . . .	.310
:FORMat[:DATA]? . . . . .	.310
:FORMat[:TRACe][:DATA] ASCii   INTeger,16   INTeger,32   REAL,32   REAL,64   UINTeGer,16 . . . . .	.310
:FORMat[:TRACe][:DATA]? . . . . .	.310
:INITiate:ACP . . . . .	.322
:INITiate:CDPower . . . . .	.328
:INITiate:CHPower . . . . .	.341
:INITiate:CONTInuous OFF   ON   0   1 . . . . .	.312
:INITiate:CONTInuous? . . . . .	.312
:INITiate:EVMQpsk . . . . .	.342
:INITiate:IM . . . . .	.345



---

# List of Commands

:INITiate:OBW	348
:INITiate:PStatistic	349
:INITiate:REStart	313
:INITiate:RHO	351
:INITiate:SEMask	366
:INITiate:SPEctrum	372
:INITiate:WAVEform	375
:INITiate:<measurement_name>	312
:INITiate[:IMMediate]	313
:INSTRument:CATalog?	315
:INSTRument:NSElect <integer>	315
:INSTRument:NSElect?	315
:INSTRument[:SElect] SA   PNOISE   BASIC   CDMA   CDMA2K   EDGE GSM   NADC   PDC   WCD- MA	316
:INSTRument[:SElect]?	316
:MEASure:ACP[n]?	322
:MEASure:CDPower[n]?	328
:MEASure:CHPower[n]?	341
:MEASure:EVMQpsk[n]?	342
:MEASure:IM[n]?	345
:MEASure:OBW[n]?	348
:MEASure:PStatistic[n]?	349
:MEASure:RHO[n]?	351
:MEASure:SEMask[n]?	366
:MEASure:SPEctrum[n]?	372
:MEASure:WAVEform[n]?	375
:READ:ACP[n]?	322
:READ:CDPower[n]?	328
:READ:CHPower[n]?	341
:READ:EVMQpsk[n]?	342
:READ:IM[n]?	345

---

# List of Commands

:READ:OBW[n]?	.348
:READ:PSTatastic[n]?	.349
:READ:RHO[n]?	.351
:READ:SEMask[n]?	.366
:READ:SPECTrum[n]?	.372
:READ:WAVEform[n]?	.375
:READ:<measurement>[n]?	.377
:TRIGger[:SEQuence]:AUTO:STATe OFF   ON   0   1	.479
:TRIGger[:SEQuence]:AUTO:STATe?	.479
:TRIGger[:SEQuence]:AUTO[:TIME] <time>	.479
:TRIGger[:SEQuence]:AUTO[:TIME]?	.479
:TRIGger[:SEQuence]:EXTernal[1]   2:DELay <time>	.480
:TRIGger[:SEQuence]:EXTernal[1]   2:DELay?	.480
:TRIGger[:SEQuence]:EXTernal[1]   2:LEVel <voltage>	.480
:TRIGger[:SEQuence]:EXTernal[1]   2:LEVel?	.480
:TRIGger[:SEQuence]:EXTernal[1]   2:SLOPe NEGative   POSitive	.480
:TRIGger[:SEQuence]:EXTernal[1]   2:SLOPe?	.481
:TRIGger[:SEQuence]:FRAMe:ADJust <time>	.481
:TRIGger[:SEQuence]:FRAMe:PERiod <time>	.481
:TRIGger[:SEQuence]:FRAMe:PERiod?	.481
:TRIGger[:SEQuence]:HOLDoff <time>	.482
:TRIGger[:SEQuence]:HOLDoff?	.482
:TRIGger[:SEQuence]:IF:DELay <time>	.482
:TRIGger[:SEQuence]:IF:DELay?	.482
:TRIGger[:SEQuence]:IF:LEVel <ampl>	.482
:TRIGger[:SEQuence]:IF:LEVel?	.482
:TRIGger[:SEQuence]:IF:SLOPe NEGative   POSitive	.483
:TRIGger[:SEQuence]:IF:SLOPe?	.483
:TRIGger[:SEQuence]:RFBurst:DELay <time>	.483
:TRIGger[:SEQuence]:RFBurst:DELay?	.483
:TRIGger[:SEQuence]:RFBurst:LEVel <rel_power>	.483

# List of Commands

:TRIGger[:SEQuence]:RFBurst:LEVel? . . . . .	483
:TRIGger[:SEQuence]:RFBurst:SLOPe NEGative   POSitive. . . . .	484
:TRIGger[:SEQuence]:RFBurst:SLOPe? . . . . .	484
[:SENSe]:ACP:AVERAge:COUNT <integer> . . . . .	378
[:SENSe]:ACP:AVERAge:COUNT? . . . . .	378
[:SENSe]:ACP:AVERAge:TCONtrol EXPonential   REPeat . . . . .	379
[:SENSe]:ACP:AVERAge:TCONtrol? . . . . .	379
[:SENSe]:ACP:AVERAge[:STATe] OFF   ON   0   1 . . . . .	378
[:SENSe]:ACP:AVERAge[:STATe]? . . . . .	378
[:SENSe]:ACP:BANDwidth[n]   BWIDth[n]:INTegration <freq> . . . . .	379
[:SENSe]:ACP:BANDwidth[n]   BWIDth[n]:INTegration? . . . . .	379
[:SENSe]:ACP:BANDwidth[n]   BWIDth[n]:INTegration[m] <freq> . . . . .	379
[:SENSe]:ACP:BANDwidth[n]   BWIDth[n]:INTegration[m]? . . . . .	379
[:SENSe]:ACP:OFFSet:LIST:ABSolute <power>,<power>,<power>,<power>,<power> . . . . .	380
[:SENSe]:ACP:OFFSet:LIST:ABSolute? . . . . .	380
[:SENSe]:ACP:OFFSet[n]:LIST:ABSolute <power>,<power>,<power>,<power>,<power> . . . . .	380
[:SENSe]:ACP:OFFSet[n]:LIST:ABSolute? . . . . .	380
[:SENSe]:ACP:OFFSet[n]:LIST:BANDwidth   BWIDth <res_bw>,<res_bw>,<res_bw>,<res_bw>,<res_bw> . . . . .	381
[:SENSe]:ACP:OFFSet[n]:LIST:BANDwidth   BWIDth? . . . . .	381
[:SENSe]:ACP:OFFSet[n]:LIST:RCARrier <rel_power>,<rel_power>,<rel_power>,<rel_power>,<rel_power> . . . . .	383
[:SENSe]:ACP:OFFSet[n]:LIST:RCARrier? . . . . .	383
[:SENSe]:ACP:OFFSet[n]:LIST:RPSDensity <rel_power>,<rel_power>,<rel_power>,<rel_power>,<rel_power> . . . . .	384
[:SENSe]:ACP:OFFSet[n]:LIST:RPSDensity? . . . . .	384
[:SENSe]:ACP:OFFSet[n]:LIST:STATe OFF   ON   0   1, OFF   ON   0   1, OFF   ON   0   1, OFF   ON   0   1, OFF   ON   0   1 . . . . .	386
[:SENSe]:ACP:OFFSet[n]:LIST:STATe? . . . . .	386
[:SENSe]:ACP:OFFSet[n]:LIST:TEST ABSolute   AND   OR   RELative, ABSolute   AND   OR   RELative, ABSolute   AND   OR   RELative, ABSolute   AND   OR   RELative, ABSolute   AND   OR   RELative . . . . .	386
[:SENSe]:ACP:OFFSet[n]:LIST:TEST? . . . . .	386

---

# List of Commands

[:SENSe]:ACP:OFFSet[n]:LIST[n]:BANDwidth   BWIDth <res_bw>,<res_bw>,<res_bw>,<res_bw>,<res_bw> . . . . .	.381
[:SENSe]:ACP:OFFSet[n]:LIST[n]:BANDwidth   BWIDth? . . . . .	.381
[:SENSe]:ACP:OFFSet[n]:LIST[n]:RCARrier <rel_power>,<rel_power>,<rel_power>,<rel_power>,<rel_power> . . . . .	.383
[:SENSe]:ACP:OFFSet[n]:LIST[n]:RCARrier? . . . . .	.383
[:SENSe]:ACP:OFFSet[n]:LIST[n]:RPSDensity <rel_power>,<rel_power>,<rel_power>,<rel_power>,<rel_power> . . . . .	.385
[:SENSe]:ACP:OFFSet[n]:LIST[n]:RPSDensity? . . . . .	.385
[:SENSe]:ACP:OFFSet[n]:LIST[n]:STATe OFF   ON   0   1, OFF   ON   0   1, OFF   ON   0   1, OFF   ON   0   1, OFF   ON   0   1 . . . . .	.386
[:SENSe]:ACP:OFFSet[n]:LIST[n]:STATe? . . . . .	.386
[:SENSe]:ACP:OFFSet[n]:LIST[n]:TEST BSolute   AND   OR   RELative, ABSolute   AND   OR   REL- ative, ABSolute   AND   OR   RELative, ABSolute   AND   OR   RELative, ABSolute   AND   OR   RELative . . .	.387
[:SENSe]:ACP:OFFSet[n]:LIST[n]:TEST? . . . . .	.387
[:SENSe]:ACP:OFFSet[n]:LIST[n]::FREQuency <f_offset>,<f_offset>,<f_offset>,<f_offset>,<f_offset> . . . . .	.382
[:SENSe]:ACP:OFFSet[n]:LIST[n]::FREQuency]? . . . . .	.382
[:SENSe]:ACP:OFFSet[n]:LIST[:FREQuency] <f_offset>,<f_offset>,<f_offset>,<f_offset>,<f_offset> . . . . .	.382
[:SENSe]:ACP:OFFSet[n]:LIST[:FREQuency]? . . . . .	.382
[:SENSe]:ACP:SWEep:BANDwidth   BWIDth[:RESolution] <freq> . . . . .	.388
[:SENSe]:ACP:SWEep:BANDwidth   BWIDth[:RESolution]:AUTO OFF   ON   0   1 . . . . .	.388
[:SENSe]:ACP:SWEep:BANDwidth   BWIDth[:RESolution]:AUTO? . . . . .	.388
[:SENSe]:ACP:SWEep:BANDwidth   BWIDth[:RESolution]? . . . . .	.388
[:SENSe]:ACP:SWEep:DETEctor[:FUNCTion] AAverage   POSitive . . . . .	.388
[:SENSe]:ACP:SWEep:DETEctor[:FUNCTion]? . . . . .	.388
[:SENSe]:ACP:SWEep:TIME <seconds> . . . . .	.389
[:SENSe]:ACP:SWEep:TIME? . . . . .	.389
[:SENSe]:ACP:SWEep:TYPE FAST   FFT   SWEep . . . . .	.389
[:SENSe]:ACP:SWEep:TYPE FFT   SWEep . . . . .	.390
[:SENSe]:ACP:SWEep:TYPE? . . . . .	.389

# List of Commands

[[:SENSe]:ACP:SWEep:TYPE? . . . . .	390
[[:SENSe]:ACP:TYPE PSDRef   TPRef . . . . .	390
[[:SENSe]:ACP:TYPE? . . . . .	390
[[:SENSe]:CDPower:CAPTure:TIME <numeric> . . . . .	391
[[:SENSe]:CDPower:CAPTure:TIME? . . . . .	391
[[:SENSe]:CDPower:CRATe <freq> . . . . .	391
[[:SENSe]:CDPower:CRATe? . . . . .	391
[[:SENSe]:CDPower:QOF 0   1   2   3 . . . . .	392
[[:SENSe]:CDPower:QOF? . . . . .	392
[[:SENSe]:CDPower:SPECtrum INVert   NORMal . . . . .	392
[[:SENSe]:CDPower:SPECtrum? . . . . .	392
[[:SENSe]:CDPower:SWEep:TIME <time> . . . . .	392
[[:SENSe]:CDPower:SWEep:TIME? . . . . .	392
[[:SENSe]:CDPower:SYNC:LCMask <integer> . . . . .	392
[[:SENSe]:CDPower:SYNC:LCMask? . . . . .	393
[[:SENSe]:CDPower:TRIGger:SOURce EXTernal[1]   External2   FRAME   IF   IMMEDIATE   RFBurst . . . . .	393
[[:SENSe]:CDPower:TRIGger:SOURce? . . . . .	393
[[:SENSe]:CHPower:AVERage:COUNt <integer> . . . . .	394
[[:SENSe]:CHPower:AVERage:COUNt? . . . . .	394
[[:SENSe]:CHPower:AVERage:TCONtrol EXPonential   REPeat . . . . .	394
[[:SENSe]:CHPower:AVERage:TCONtrol? . . . . .	394
[[:SENSe]:CHPower:AVERage[:STATe] OFF   ON   0   1 . . . . .	394
[[:SENSe]:CHPower:AVERage[:STATe]? . . . . .	394
[[:SENSe]:CHPower:BANDwidth   BWIDth:INTegration <freq> . . . . .	395
[[:SENSe]:CHPower:BANDwidth   BWIDth:INTegration? . . . . .	395
[[:SENSe]:CHPower:FREQuency:SPAN <freq> . . . . .	395
[[:SENSe]:CHPower:FREQuency:SPAN? . . . . .	395
[[:SENSe]:CHPower:POINts <integer> . . . . .	396
[[:SENSe]:CHPower:POINts:AUTO OFF   ON   0   1 . . . . .	396
[[:SENSe]:CHPower:POINts:AUTO? . . . . .	396

---

# List of Commands

[:SENSe]:CHPower:POINts? . . . . .	.396
[:SENSe]:CHPower:SWEep:TIME <time> . . . . .	.396
[:SENSe]:CHPower:SWEep:TIME:AUTO OFF   ON   0   1 . . . . .	.397
[:SENSe]:CHPower:SWEep:TIME:AUTO? . . . . .	.397
[:SENSe]:CHPower:SWEep:TIME? . . . . .	.396
[:SENSe]:CHPower:TRIGger:SOURce? . . . . .	.397
[:SENSe]:CORRection:BTS[:RF]:LOSS <rel_power> . . . . .	.398
[:SENSe]:CORRection:BTS[:RF]:LOSS? . . . . .	.398
[:SENSe]:CORRection:MS[:RF]:LOSS <rel_power> . . . . .	.398
[:SENSe]:CORRection:MS[:RF]:LOSS? . . . . .	.398
[:SENSe]:EVMQpsk:AVERage:COUNT <integer> . . . . .	.399
[:SENSe]:EVMQpsk:AVERage:COUNT? . . . . .	.399
[:SENSe]:EVMQpsk:AVERage:TCONtrol EXPonential   REPeat . . . . .	.399
[:SENSe]:EVMQpsk:AVERage:TCONtrol? . . . . .	.399
[:SENSe]:EVMQpsk:AVERage[:STATe] OFF   ON   0   1 . . . . .	.399
[:SENSe]:EVMQpsk:AVERage[:STATe]? . . . . .	.399
[:SENSe]:EVMQpsk:CRATe <freq> . . . . .	.400
[:SENSe]:EVMQpsk:CRATe? . . . . .	.400
[:SENSe]:EVMQpsk:RFCarrier MULTiple   SINGle . . . . .	.400
[:SENSe]:EVMQpsk:RFCarrier? . . . . .	.400
[:SENSe]:EVMQpsk:SWEep:POINts <integer> . . . . .	.401
[:SENSe]:EVMQpsk:SWEep:POINts? . . . . .	.401
[:SENSe]:EVMQpsk:TRIGger:SOURce EXTernal[1]   EXTernal2   FRAME   IF   IMMEDIATE   RFBurst. 401	
[:SENSe]:EVMQpsk:TRIGger:SOURce? . . . . .	.401
[:SENSe]:FEED RF   AREFERENCE   IFAlign . . . . .	.402
[:SENSe]:FEED? . . . . .	.402
[:SENSe]:IM:AVERage:COUNT <number> . . . . .	.403
[:SENSe]:IM:AVERage:COUNT? . . . . .	.403
[:SENSe]:IM:AVERage:TCONtrol EXPonential   REPeat . . . . .	.403
[:SENSe]:IM:AVERage:TCONtrol? . . . . .	.403

# List of Commands

[:SENSe]:IM:AVERage[:STATe] OFF   ON   0   1	403
[:SENSe]:IM:AVERage[:STATe]?	403
[:SENSe]:IM:BANDwidth   BWIDth:INTegration <freq>	404
[:SENSe]:IM:BANDwidth   BWIDth:INTegration?	404
[:SENSe]:IM:BANDwidth   BWIDth[:RESolution] <freq>	404
[:SENSe]:IM:BANDwidth   BWIDth[:RESolution]:AUTO OFF   ON   0   1	405
[:SENSe]:IM:BANDwidth   BWIDth[:RESolution]:AUTO?	405
[:SENSe]:IM:BANDwidth   BWIDth[:RESolution]?	404
[:SENSe]:IM:FREQuency:AUTO OFF   ON   0   1	405
[:SENSe]:IM:FREQuency:AUTO?	405
[:SENSe]:IM:FREQuency:SPAN <freq>	406
[:SENSe]:IM:FREQuency:SPAN?	406
[:SENSe]:IM:FREQuency[:BASE]:DELTA <freq>	405
[:SENSe]:IM:FREQuency[:BASE]:DELTA?	405
[:SENSe]:IM:FREQuency[:BASE]:LOWer <freq>	406
[:SENSe]:IM:FREQuency[:BASE]:LOWer?	406
[:SENSe]:IM:FREQuency[:BASE]:UPPer <freq>	406
[:SENSe]:IM:FREQuency[:BASE]:UPPer?	406
[:SENSe]:IM:MODE AUTO   TWOTone   TXIM	407
[:SENSe]:IM:MODE?	407
[:SENSe]:IM:REFerence AUTO   AVERage   LOWer   UPPer	407
[:SENSe]:IM:REFerence?	407
[:SENSe]:OBW:AVERage:COUNt <integer>	409
[:SENSe]:OBW:AVERage:COUNt?	409
[:SENSe]:OBW:AVERage:TCONtrol EXPonential   REPeat	409
[:SENSe]:OBW:AVERage:TCONtrol?	410
[:SENSe]:OBW:AVERage[:STATe] OFF   ON   0   1	409
[:SENSe]:OBW:AVERage[:STATe]?	409
[:SENSe]:OBW:BANDwidth   BWIDth[:RESolution] <freq>	410
[:SENSe]:OBW:BANDwidth   BWIDth[:RESolution]?	410
[:SENSe]:OBW:FFT:WINDow[:TYPE]	

---

# List of Commands

BH4Tap   BLACkman   FLATtop   GAUSSian   HAMMING   HANNing   KB70   KB90   KB110   UNIFor m .....	410
[:SENSe]:OBW:FFT:WINDow[:TYPE]? .....	410
[:SENSe]:OBW:FREQuency:SPAN <freq> .....	411
[:SENSe]:OBW:FREQuency:SPAN? .....	411
[:SENSe]:OBW:TRIGger:SOURce EXTernal[1]   EXTernal2   FRAME   IF   IMMEDIATE   LINE   RF- Burst .....	411
[:SENSe]:OBW:TRIGger:SOURce EXTernal[1]   EXTernal2   IF   IMMEDIATE   RFBurst .....	411
[:SENSe]:OBW:TRIGger:SOURce? .....	411
[:SENSe]:OBW:TRIGger:SOURce? .....	411
[:SENSe]:POWer[:RF]:ATTenuation <rel_power> .....	413
[:SENSe]:POWer[:RF]:ATTenuation? .....	413
[:SENSe]:POWer[:RF]:GAIN:ATTenuation <rel_power> .....	413
[:SENSe]:POWer[:RF]:GAIN:ATTenuation? .....	413
[:SENSe]:POWer[:RF]:GAIN[:STATe] OFF   ON   0   1 .....	413
[:SENSe]:POWer[:RF]:GAIN[:STATe]? .....	413
[:SENSe]:POWer[:RF]:RANGe:AUTO OFF   ON   0   1 .....	414
[:SENSe]:POWer[:RF]:RANGe:AUTO? .....	414
[:SENSe]:POWer[:RF]:RANGe[:UPPer] <power> .....	414
[:SENSe]:POWer[:RF]:RANGe[:UPPer]? .....	414
[:SENSe]:PSTATistic:BANDwidth   BWIDth <freq> .....	415
[:SENSe]:PSTATistic:BANDwidth   BWIDth? .....	415
[:SENSe]:PSTATistic:COUNTs <integer> .....	416
[:SENSe]:PSTATistic:COUNTs? .....	416
[:SENSe]:PSTATistic:SWEep:TIME <time> .....	416
[:SENSe]:PSTATistic:SWEep:TIME? .....	416
[:SENSe]:PSTATistic:TRIGger:SOURce EXTernal[1]   EXTernal2   FRAME   IF   IMMEDIATE   RFBurst. 416	
[:SENSe]:PSTATistic:TRIGger:SOURce? .....	416
[:SENSe]:RADio:DEVIce BTS   MS .....	418
[:SENSe]:RADio:DEVIce? .....	418
[:SENSe]:RHO:AVERage:COUNT <integer> .....	419



# List of Commands

[:SENSe]:RHO:AVERAge:COUNT? . . . . .	419
[:SENSe]:RHO:AVERAge:TCONtrol EXPOnential   REPeat . . . . .	419
[:SENSe]:RHO:AVERAge:TCONtrol? . . . . .	419
[:SENSe]:RHO:AVERAge[:STATe] OFF   ON   0   1 . . . . .	419
[:SENSe]:RHO:AVERAge[:STATe]? . . . . .	419
[:SENSe]:RHO:CRATe <freq> . . . . .	420
[:SENSe]:RHO:CRATe? . . . . .	420
[:SENSe]:RHO:MCEStimator OFF   ON   0   1 . . . . .	420
[:SENSe]:RHO:MCEStimator? . . . . .	420
[:SENSe]:RHO:SPECtrum INVert   NORMal . . . . .	421
[:SENSe]:RHO:SPECtrum? . . . . .	421
[:SENSe]:RHO:SYNC:LCMask <integer> . . . . .	421
[:SENSe]:RHO:SYNC:LCMask? . . . . .	421
[:SENSe]:RHO:TRIGger:SOURce EXTernal[1]   EXternal2   FRAMe   IF   IMMEdiate   RFBurst . . . . .	421
[:SENSe]:RHO:TRIGger:SOURce? . . . . .	421
[:SENSe]:SEMask:AVERAge:COUNT <integer> . . . . .	423
[:SENSe]:SEMask:AVERAge:COUNT? . . . . .	423
[:SENSe]:SEMask:AVERAge[:STATe] OFF   ON   0   1 . . . . .	423
[:SENSe]:SEMask:AVERAge[:STATe]? . . . . .	423
[:SENSe]:SEMask:BANDwidth[n]   BWIDth[n]:INTegration <freq> . . . . .	423
[:SENSe]:SEMask:BANDwidth[n]   BWIDth[n]:INTegration? . . . . .	423
[:SENSe]:SEMask:BANDwidth[n]   BWIDth[n]:RESolution <freq> . . . . .	424
[:SENSe]:SEMask:BANDwidth[n]   BWIDth[n]:RESolution:AUTO OFF   ON   0   1 . . . . .	425
[:SENSe]:SEMask:BANDwidth[n]   BWIDth[n]:RESolution:AUTO? . . . . .	425
[:SENSe]:SEMask:BANDwidth[n]   BWIDth[n]:RESolution? . . . . .	424
[:SENSe]:SEMask:BANDwidth   BWIDth:INTegration[m] <freq> . . . . .	424
[:SENSe]:SEMask:BANDwidth   BWIDth:INTegration[m]? . . . . .	424
[:SENSe]:SEMask:BANDwidth   BWIDth:RESolution[m] <freq> . . . . .	424
[:SENSe]:SEMask:BANDwidth   BWIDth:RESolution[m]:AUTO OFF   ON   0   1 . . . . .	425
[:SENSe]:SEMask:BANDwidth   BWIDth:RESolution[m]:AUTO? . . . . .	425
[:SENSe]:SEMask:BANDwidth   BWIDth:RESolution[m]? . . . . .	424

---

# List of Commands

[[:SENSE]:SEMAsk:DETECTOR[:FUNCTION] AAVerage   POSitive	425
[[:SENSE]:SEMAsk:DETECTOR[:FUNCTION]?	425
[[:SENSE]:SEMAsk:FREQUENCY:STEP[m] <freq>	426
[[:SENSE]:SEMAsk:FREQUENCY:STEP[m]:AUTO OFF   ON   0   1	427
[[:SENSE]:SEMAsk:FREQUENCY:STEP[m]:AUTO?	427
[[:SENSE]:SEMAsk:FREQUENCY:STEP[m]?	426
[[:SENSE]:SEMAsk:FREQUENCY[n]:SPAN[m] <freq>	426
[[:SENSE]:SEMAsk:FREQUENCY[n]:SPAN[m]?	426
[[:SENSE]:SEMAsk:FREQUENCY[n]:STEP <freq>	426
[[:SENSE]:SEMAsk:FREQUENCY[n]:STEP:AUTO OFF   ON   0   1	427
[[:SENSE]:SEMAsk:FREQUENCY[n]:STEP:AUTO?	427
[[:SENSE]:SEMAsk:FREQUENCY[n]:STEP?	426
[[:SENSE]:SEMAsk:OFFSet:LIST[m]:BANDwidth   BWIDth <res_bw>,<res_bw>,<res_bw>,<res_bw>,<res_bw>	428
[[:SENSE]:SEMAsk:OFFSet:LIST[m]:BANDwidth   BWIDth:AUTO OFF   ON   0   1,OFF   ON   0   1,OFF   ON   0   1,OFF   ON   0   1,OFF   ON   0   1	429
[[:SENSE]:SEMAsk:OFFSet:LIST[m]:BANDwidth   BWIDth:AUTO?	429
[[:SENSE]:SEMAsk:OFFSet:LIST[m]:BANDwidth   BWIDth:IMULti <integer>,<integer>,<integer>,<integer>,<integer>	430
[[:SENSE]:SEMAsk:OFFSet:LIST[m]:BANDwidth   BWIDth:IMULti?	430
[[:SENSE]:SEMAsk:OFFSet:LIST[m]:BANDwidth   BWIDth?	428
[[:SENSE]:SEMAsk:OFFSet:LIST[m]:FREQUENCY:START <f_offset>,<f_offset>,<f_offset>,<f_offset>,<f_offset>	430
[[:SENSE]:SEMAsk:OFFSet:LIST[m]:FREQUENCY:START?	430
[[:SENSE]:SEMAsk:OFFSet:LIST[m]:FREQUENCY:STEP <f_offset>,<f_offset>,<f_offset>,<f_offset>,<f_offset>	431
[[:SENSE]:SEMAsk:OFFSet:LIST[m]:FREQUENCY:STEP:AUTO OFF   ON   0   1,OFF   ON   0   1,OFF   ON   0   1,OFF   ON   0   1,OFF   ON   0   1	432
[[:SENSE]:SEMAsk:OFFSet:LIST[m]:FREQUENCY:STEP:AUTO?	432
[[:SENSE]:SEMAsk:OFFSet:LIST[m]:FREQUENCY:STEP?	431
[[:SENSE]:SEMAsk:OFFSet:LIST[m]:FREQUENCY:STOP <f_offset>,<f_offset>,<f_offset>,<f_offset>,<f_offset>	433
[[:SENSE]:SEMAsk:OFFSet:LIST[m]:FREQUENCY:STOP?	433
[[:SENSE]:SEMAsk:OFFSet:LIST[m]:RATTenuation	

# List of Commands

<rel_power>,<rel_power>,<rel_power>,<rel_power>,<rel_power> . . . . .	434
[:SENSe]:SEMAsk:OFFSet:LIST[m]:RATTenuation? . . . . .	434
[:SENSe]:SEMAsk:OFFSet:LIST[m]:SIDE BOTH   NEGAtive   POSitive, BOTH   NEGAtive   POSitive,BOTH   NEGAtive   POSitive, BOTH   NEGAtive   POSi- tive,BOTH   NEGAtive   POSitive . . . . .	435
[:SENSe]:SEMAsk:OFFSet:LIST[m]:SIDE? . . . . .	435
[:SENSe]:SEMAsk:OFFSet:LIST[m]:START:ABSolute <abs_power>,<abs_power>,<abs_power>,<abs_power>,<abs_power> . . . . .	436
[:SENSe]:SEMAsk:OFFSet:LIST[M]:START:ABSolute? . . . . .	436
[:SENSe]:SEMAsk:OFFSet:LIST[m]:START:RCARrier <rel_power>,<rel_power>,<rel_power>,<rel_power>,<rel_power> . . . . .	437
[:SENSe]:SEMAsk:OFFSet:LIST[m]:START:RCARrier? . . . . .	437
[:SENSe]:SEMAsk:OFFSet:LIST[m]:STATe OFF   ON   0   1,OFF   ON   0   1,OFF   ON   0   1,OFF   ON   0   1,OFF   ON   0   1 . . . . .	438
[:SENSe]:SEMAsk:OFFSet:LIST[m]:STATe? . . . . .	438
[:SENSe]:SEMAsk:OFFSet:LIST[m]:STOP:ABSolute <abs_power>,<abs_power>,<abs_power>,<abs_power>,<abs_power> . . . . .	439
[:SENSe]:SEMAsk:OFFSet:LIST[m]:STOP:ABSolute:COUple OFF   ON   0   1,OFF   ON   0   1,OFF   ON   0   1,OFF   ON   0   1,OFF   ON   0   1 . . . . .	441
[:SENSe]:SEMAsk:OFFSet:LIST[m]:STOP:ABSolute:COUple? . . . . .	441
[:SENSe]:SEMAsk:OFFSet:LIST[m]:STOP:ABSolute? . . . . .	439
[:SENSe]:SEMAsk:OFFSet:LIST[m]:STOP:RCARrier <rel_power>,<rel_power>,<rel_power>,<rel_power>,<rel_power> . . . . .	441
[:SENSe]:SEMAsk:OFFSet:LIST[m]:STOP:RCARrier:COUple OFF   ON   0   1,OFF   ON   0   1,OFF   ON   0   1,OFF   ON   0   1,OFF   ON   0   1 . . . . .	443
[:SENSe]:SEMAsk:OFFSet:LIST[m]:STOP:RCARrier:COUple? . . . . .	443
[:SENSe]:SEMAsk:OFFSet:LIST[m]:STOP:RCARrier? . . . . .	441
[:SENSe]:SEMAsk:OFFSet:LIST[m]:TEST ABSolute   AND   OR   RELative,ABSolute   AND   OR   RELative, ABSolute   AND   OR   RELative,ABSolute   AND   OR   RELative, ABSolute   AND   OR   RELative . . . . .	443
[:SENSe]:SEMAsk:OFFSet:LIST[m]:TEST? . . . . .	444
[:SENSe]:SEMAsk:OFFSet[n]:LIST:BANDwidth   BWIDth <res_bw>,<res_bw>,<res_bw>,<res_bw>,<res_bw> . . . . .	428
[:SENSe]:SEMAsk:OFFSet[n]:LIST:BANDwidth   BWIDth:AUTO OFF   ON   0   1,OFF   ON   0   1,OFF   ON   0   1,OFF   ON   0   1,OFF   ON   0   1 . . . . .	429

---

# List of Commands

[:SENSe]:SEMAsk:OFFSet[n]:LIST:BANDwidth   BWIDth:AUTO? .....	429
[:SENSe]:SEMAsk:OFFSet[n]:LIST:BANDwidth   BWIDth:IMULti <integer>,<integer>,<integer>,<integer>,<integer> .....	429
[:SENSe]:SEMAsk:OFFSet[n]:LIST:BANDwidth   BWIDth:IMULti? .....	429
[:SENSe]:SEMAsk:OFFSet[n]:LIST:BANDwidth   BWIDth? .....	428
[:SENSe]:SEMAsk:OFFSet[n]:LIST:FREQuency:STARt <f_offset>,<f_offset>,<f_offset>,<f_offset>,<f_offset> .....	430
[:SENSe]:SEMAsk:OFFSet[n]:LIST:FREQuency:STARt? .....	430
[:SENSe]:SEMAsk:OFFSet[n]:LIST:FREQuency:STEP <f_offset>,<f_offset>,<f_offset>,<f_offset>,<f_offset> .....	431
[:SENSe]:SEMAsk:OFFSet[n]:LIST:FREQuency:STEP:AUTO OFF   ON   0   1,OFF   ON   0   1,OFF   ON   0   1,OFF   ON   0   1,OFF   ON   0   1 .....	432
[:SENSe]:SEMAsk:OFFSet[n]:LIST:FREQuency:STEP:AUTO? .....	432
[:SENSe]:SEMAsk:OFFSet[n]:LIST:FREQuency:STEP? .....	431
[:SENSe]:SEMAsk:OFFSet[n]:LIST:FREQuency:STOP <f_offset>,<f_offset>,<f_offset>,<f_offset>,<f_offset> .....	433
[:SENSe]:SEMAsk:OFFSet[n]:LIST:FREQuency:STOP? .....	433
[:SENSe]:SEMAsk:OFFSet[n]:LIST:RATTenuation <rel_power>,<rel_power>,<rel_power>,<rel_power>,<rel_power> .....	434
[:SENSe]:SEMAsk:OFFSet[n]:LIST:RATTenuation? .....	434
[:SENSe]:SEMAsk:OFFSet[n]:LIST:SIDE BOTH   NEGative   POSitive, BOTH   NEGative   POSitive,BOTH   NEGative   POSitive, BOTH   NEGative   POSi- tive,BOTH   NEGative   POSitive. ....	435
[:SENSe]:SEMAsk:OFFSet[n]:LIST:SIDE? .....	435
[:SENSe]:SEMAsk:OFFSet[n]:LIST:STARt:ABSolute <abs_power>,<abs_power>,<abs_power>,<abs_power>,<abs_power> .....	436
[:SENSe]:SEMAsk:OFFSet[n]:LIST:STARt:ABSolute? .....	436
[:SENSe]:SEMAsk:OFFSet[n]:LIST:STARt:RCARrier <rel_power>,<rel_power>,<rel_power>,<rel_power>,<rel_power> .....	437
[:SENSe]:SEMAsk:OFFSet[n]:LIST:STARt:RCARrier? .....	437
[:SENSe]:SEMAsk:OFFSet[n]:LIST:STATe OFF   ON   0   1,OFF   ON   0   1,OFF   ON   0   1,OFF   ON   0   1,OFF   ON   0   1 .....	438
[:SENSe]:SEMAsk:OFFSet[n]:LIST:STATe? .....	438
[:SENSe]:SEMAsk:OFFSet[n]:LIST:STOP:ABSolute <abs_power>,<abs_power>,<abs_power>,<abs_power>,<abs_power> .....	439

# List of Commands

[:SENSe]:SEMAsk:OFFSet[n]:LIST:STOP:ABSolute:COUPle OFF   ON   0   1,OFF   ON   0   1,OFF   ON   0   1,OFF   ON   0   1,OFF   ON   0   1	440
[:SENSe]:SEMAsk:OFFSet[n]:LIST:STOP:ABSolute:COUPle?	440
[:SENSe]:SEMAsk:OFFSet[n]:LIST:STOP:ABSolute?	439
[:SENSe]:SEMAsk:OFFSet[n]:LIST:STOP:RCARrier <rel_power>,<rel_power>,<rel_power>,<rel_power>,<rel_power>	441
[:SENSe]:SEMAsk:OFFSet[n]:LIST:STOP:RCARrier:COUPle OFF   ON   0   1,OFF   ON   0   1,OFF   ON   0   1,OFF   ON   0   1,OFF   ON   0   1	442
[:SENSe]:SEMAsk:OFFSet[n]:LIST:STOP:RCARrier:COUPle?	442
[:SENSe]:SEMAsk:OFFSet[n]:LIST:STOP:RCARrier?	441
[:SENSe]:SEMAsk:OFFSet[n]:LIST:TEST ABSolute   AND   OR   RELative,ABSolute   AND   OR   RELative, ABSolute   AND   OR   RELative,ABSolute   AND   OR   RELative, ABSolute   AND   OR   RELative	443
[:SENSe]:SEMAsk:OFFSet[n]:LIST:TEST?	443
[:SENSe]:SEMAsk:REGion:LIST:BANDwidth   BWIDth <res_bw>,<res_bw>,<res_bw>,<res_bw>,<res_bw>	445
[:SENSe]:SEMAsk:REGion:LIST:BANDwidth   BWIDth:AUTO OFF   ON   0   1,OFF   ON   0   1,OFF   ON   0   1,OFF   ON   0   1,OFF   ON   0   1	446
[:SENSe]:SEMAsk:REGion:LIST:BANDwidth   BWIDth:AUTO?	446
[:SENSe]:SEMAsk:REGion:LIST:BANDwidth   BWIDth?	445
[:SENSe]:SEMAsk:REGion:LIST:FREQuency:START <f_region>,<f_region>,<f_region>,<f_region>,<f_region>	446
[:SENSe]:SEMAsk:REGion:LIST:FREQuency:START?	446
[:SENSe]:SEMAsk:REGion:LIST:FREQuency:STEP <f_region>,<f_region>,<f_region>,<f_region>,<f_region>	447
[:SENSe]:SEMAsk:REGion:LIST:FREQuency:STEP:AUTO OFF   ON   0   1,OFF   ON   0   1,OFF   ON   0   1,OFF   ON   0   1,OFF   ON   0   1	448
[:SENSe]:SEMAsk:REGion:LIST:FREQuency:STEP:AUTO?	448
[:SENSe]:SEMAsk:REGion:LIST:FREQuency:STEP?	447
[:SENSe]:SEMAsk:REGion:LIST:FREQuency:STOP <f_region>,<f_region>,<f_region>,<f_region>,<f_region>	449
[:SENSe]:SEMAsk:REGion:LIST:FREQuency:STOP?	449
[:SENSe]:SEMAsk:REGion:LIST:RATTenuation <rel_power>,<rel_power>,<rel_power>,<rel_power>,<rel_power>	449
[:SENSe]:SEMAsk:REGion:LIST:RATTenuation?	449

---

# List of Commands

[:SENSe]:SEMAsk:REGion:LIST:STARt:ABSolute <abs_power>,<abs_power> . . . . .	450
[:SENSe]:SEMAsk:REGion:LIST:STARt:ABSolute? . . . . .	451
[:SENSe]:SEMAsk:REGion:LIST:STARt:RCARrier <rel_power>,<rel_power>,<rel_power>,<rel_power>,<rel_power> . . . . .	451
[:SENSe]:SEMAsk:REGion:LIST:STARt:RCARrier? . . . . .	451
[:SENSe]:SEMAsk:REGion:LIST:STATe OFF   ON   0   1,OFF   ON   0   1,OFF   ON   0   1,OFF   ON   0   1,OFF   ON   0   1 . . . . .	452
[:SENSe]:SEMAsk:REGion:LIST:STATe? . . . . .	452
[:SENSe]:SEMAsk:REGion:LIST:STOP:ABSolute <abs_power>,<abs_power>,<abs_power>,<abs_power>,<abs_power> . . . . .	453
[:SENSe]:SEMAsk:REGion:LIST:STOP:ABSolute? . . . . .	453
[:SENSe]:SEMAsk:REGion:LIST:STOP:RCARrier <rel_power>,<rel_power>,<rel_power>,<rel_power>,<rel_power> . . . . .	455
[:SENSe]:SEMAsk:REGion:LIST:STOP:RCARrier:COUPle OFF   ON   0   1,OFF   ON   0   1,OFF   ON   0   1,OFF   ON   0   1,OFF   ON   0   1 . . . . .	456
[:SENSe]:SEMAsk:REGion:LIST:STOP:RCARrier:COUPle? . . . . .	456
[:SENSe]:SEMAsk:REGion:LIST:STOP:RCARrier? . . . . .	455
[:SENSe]:SEMAsk:REGion:LIST:TEST ABSolute   AND   OR   RELative,ABSolute   AND   OR   RELa- tive, ABSolute   AND   OR   RELative,ABSolute   AND   OR   RELative, ABSolute   AND   OR   RELative. . . . .	456
[:SENSe]:SEMAsk:REGion:LIST:TEST? . . . . .	456
[:SENSe]:SEMAsk:REGion[n]:LIST:BANDwidth   BWIDth <res_bw>,<res_bw>,<res_bw>,<res_bw>,<res_bw> . . . . .	445
[:SENSe]:SEMAsk:REGion[n]:LIST:BANDwidth   BWIDth:AUTO OFF   ON   0   1,OFF   ON   0   1,OFF   ON   0   1,OFF   ON   0   1,OFF   ON   0   1 . . . . .	445
[:SENSe]:SEMAsk:REGion[n]:LIST:BANDwidth   BWIDth:AUTO? . . . . .	445
[:SENSe]:SEMAsk:REGion[n]:LIST:BANDwidth   BWIDth? . . . . .	445
[:SENSe]:SEMAsk:REGion[n]:LIST:FREQuency:STARt <f_region>,<f_region>,<f_region>,<f_region>,<f_region> . . . . .	446
[:SENSe]:SEMAsk:REGion[n]:LIST:FREQuency:STARt? . . . . .	446
[:SENSe]:SEMAsk:REGion[n]:LIST:FREQuency:STEP <f_region>,<f_region>,<f_region>,<f_region>,<f_region> . . . . .	447
[:SENSe]:SEMAsk:REGion[n]:LIST:FREQuency:STEP:AUTO OFF   ON   0   1,OFF   ON   0   1,OFF   ON   0   1,OFF   ON   0   1,OFF   ON   0   1 . . . . .	448

# List of Commands

[:SENSe]:SEMAsk:REGion[n]:LIST:FREQuency:STEP:AUTO? .....	448
[:SENSe]:SEMAsk:REGion[n]:LIST:FREQuency:STEP? .....	447
[:SENSe]:SEMAsk:REGion[n]:LIST:FREQuency:STOP <f_region>,<f_region>,<f_region>,<f_region>,<f_region> .....	448
[:SENSe]:SEMAsk:REGion[n]:LIST:FREQuency:STOP? .....	449
[:SENSe]:SEMAsk:REGion[n]:LIST:RATTenuation <rel_power>,<rel_power>,<rel_power>,<rel_power>,<rel_power> .....	449
[:SENSe]:SEMAsk:REGion[n]:LIST:RATTenuation? .....	449
[:SENSe]:SEMAsk:REGion[n]:LIST:STARt:ABSolute <abs_power>,<abs_power> .....	450
[:SENSe]:SEMAsk:REGion[n]:LIST:STARt:ABSolute? .....	450
[:SENSe]:SEMAsk:REGion[n]:LIST:STARt:RCARrier <rel_power>,<rel_power>,<rel_power>,<rel_power>,<rel_power> .....	451
[:SENSe]:SEMAsk:REGion[n]:LIST:STARt:RCARrier? .....	451
[:SENSe]:SEMAsk:REGion[n]:LIST:STATe OFF   ON   0   1,OFF   ON   0   1,OFF   ON   0   1,OFF   ON   0   1,OFF   ON   0   1 .....	452
[:SENSe]:SEMAsk:REGion[n]:LIST:STATe? .....	452
[:SENSe]:SEMAsk:REGion[n]:LIST:STOP:ABSolute <abs_power>,<abs_power>,<abs_power>,<abs_power>,<abs_power> .....	453
[:SENSe]:SEMAsk:REGion[n]:LIST:STOP:ABSolute:COUple OFF   ON   0   1,OFF   ON   0   1} .....	454
[:SENSe]:SEMAsk:REGion[n]:LIST:STOP:ABSolute:COUple? .....	454
[:SENSe]:SEMAsk:REGion[n]:LIST:STOP:ABSolute? .....	453
[:SENSe]:SEMAsk:REGion[n]:LIST:STOP:RCARrier <rel_power>,<rel_power>,<rel_power>,<rel_power>,<rel_power> .....	455
[:SENSe]:SEMAsk:REGion[n]:LIST:STOP:RCARrier:COUple OFF   ON   0   1,OFF   ON   0   1,OFF   ON   0   1,OFF   ON   0   1,OFF   ON   0   1 .....	456
[:SENSe]:SEMAsk:REGion[n]:LIST:STOP:RCARrier:COUple? .....	456
[:SENSe]:SEMAsk:REGion[n]:LIST:STOP:RCARrier? .....	455
[:SENSe]:SEMAsk:REGion[n]:LIST:TEST ABSolute   AND   OR   RELative,ABSolute   AND   OR   RELative, ABSolute   AND   OR   RELative,ABSolute   AND   OR   RELative, ABSolute   AND   OR   RELative .....	456
[:SENSe]:SEMAsk:REGion[n]:LIST:TEST? .....	456
[:SENSe]:SEMAsk:SEGMENT OFFSet   REGion .....	457

---

# List of Commands

[:SENSe]:SEMAsk:SEGMENT? . . . . .	457
[:SENSe]:SEMAsk:SWEep:TIME <time>   <no. of chips> . . . . .	458
[:SENSe]:SEMAsk:SWEep:TIME? . . . . .	458
[:SENSe]:SEMAsk:TRIGger:SOURce EXTernal[1]   EXTernal2   FRAME   IMMEDIATE   LINE . . . . .	458
[:SENSe]:SEMAsk:TRIGger:SOURce? . . . . .	458
[:SENSe]:SEMAsk:TYPE PSDRef . . . . .	459
[:SENSe]:SEMAsk:TYPE? . . . . .	459
[:SENSe]:SPECTrum:ACQuisition:PACKing AUTO   LONG   MEDIUM   SHORT . . . . .	460
[:SENSe]:SPECTrum:ACQuisition:PACKing? . . . . .	460
[:SENSe]:SPECTrum:ADC:DITHer[:STATe] AUTO   ON   OFF   2   1   0 . . . . .	460
[:SENSe]:SPECTrum:ADC:DITHer[:STATe]? . . . . .	460
[:SENSe]:SPECTrum:ADC:RANGe AUTO   APEak   APLock   NONE   P0   P6   P12   P18 . . . . .	460
[:SENSe]:SPECTrum:ADC:RANGe? . . . . .	460
[:SENSe]:SPECTrum:AVERAge:CLear . . . . .	461
[:SENSe]:SPECTrum:AVERAge:COUNT <integer> . . . . .	462
[:SENSe]:SPECTrum:AVERAge:COUNT? . . . . .	462
[:SENSe]:SPECTrum:AVERAge:TCONtrol EXPonential   REPeat . . . . .	462
[:SENSe]:SPECTrum:AVERAge:TCONtrol? . . . . .	462
[:SENSe]:SPECTrum:AVERAge:TYPE LOG   MAXimum   MINimum   RMS   SCALar . . . . .	463
[:SENSe]:SPECTrum:AVERAge:TYPE? . . . . .	463
[:SENSe]:SPECTrum:AVERAge[:STATe] OFF   ON   0   1 . . . . .	462
[:SENSe]:SPECTrum:AVERAge[:STATe]? . . . . .	462
[:SENSe]:SPECTrum:BANDwidth   BWIDth:IF:AUTO OFF   ON   0   1 . . . . .	463
[:SENSe]:SPECTrum:BANDwidth   BWIDth:IF:AUTO? . . . . .	463
[:SENSe]:SPECTrum:BANDwidth   BWIDth:IF:FLATness OFF   ON   0   1 . . . . .	464
[:SENSe]:SPECTrum:BANDwidth   BWIDth:IF:FLATness? . . . . .	464
[:SENSe]:SPECTrum:BANDwidth   BWIDth:PADC OFF   ON   0   1 . . . . .	464
[:SENSe]:SPECTrum:BANDwidth   BWIDth:PADC? . . . . .	464
[:SENSe]:SPECTrum:BANDwidth   BWIDth:PFFT:TYPE FLAT   GAUSSian . . . . .	465
[:SENSe]:SPECTrum:BANDwidth   BWIDth:PFFT:TYPE? . . . . .	465
[:SENSe]:SPECTrum:BANDwidth   BWIDth:PFFT[:SIZE] <freq> . . . . .	464



# List of Commands

[[:SENSe]:SPECTrum: BANDwidth   BWIDth: PFFT[:SIZE]? .....	464
[[:SENSe]:SPECTrum: BANDwidth   BWIDth[:RESolution] <freq> .....	465
[[:SENSe]:SPECTrum: BANDwidth   BWIDth[:RESolution]: AUTO OFF   ON   0   1 .....	466
[[:SENSe]:SPECTrum: BANDwidth   BWIDth[:RESolution]: AUTO? .....	466
[[:SENSe]:SPECTrum: BANDwidth   BWIDth[:RESolution]? .....	465
[[:SENSe]:SPECTrum: DECimate[:FACTor] <integer> .....	466
[[:SENSe]:SPECTrum: DECimate[:FACTor]? .....	466
[[:SENSe]:SPECTrum: FFT: LENGth <integer> .....	466
[[:SENSe]:SPECTrum: FFT: LENGth: AUTO OFF   ON   0   1 .....	467
[[:SENSe]:SPECTrum: FFT: LENGth: AUTO? .....	467
[[:SENSe]:SPECTrum: FFT: LENGth? .....	466
[[:SENSe]:SPECTrum: FFT: RBWPoints <real> .....	467
[[:SENSe]:SPECTrum: FFT: RBWPoints? .....	467
[[:SENSe]:SPECTrum: FFT: WINDow: DELay <real> .....	468
[[:SENSe]:SPECTrum: FFT: WINDow: DELay? .....	468
[[:SENSe]:SPECTrum: FFT: WINDow: LENGth <integer> .....	468
[[:SENSe]:SPECTrum: FFT: WINDow: LENGth? .....	468
[[:SENSe]:SPECTrum: FFT: WINDow[:TYPE] BH4Tap   BLACKman   FLATtop   GAUSSian   HAM- Ming   HANNing   KB70   KB90   KB110   UNIFORM .....	468
[[:SENSe]:SPECTrum: FFT: WINDow[:TYPE]? .....	469
[[:SENSe]:SPECTrum: FREQuency: SPAN <freq> .....	469
[[:SENSe]:SPECTrum: FREQuency: SPAN? .....	469
[[:SENSe]:SPECTrum: SWEep: TIME: AUTO OFF   ON   0   1 .....	470
[[:SENSe]:SPECTrum: SWEep: TIME: AUTO .....	470
[[:SENSe]:SPECTrum: SWEep: TIME? .....	470
[[:SENSe]:SPECTrum: SWEep: TIME[:VALue] <time> .....	470
[[:SENSe]:SPECTrum: TRIGger: SOURce EXTernal[1]   EXTernal2   FRAME   IF   LINE   IMMEDIATE   RFBurst .....	470
[[:SENSe]:SPECTrum: TRIGger: SOURce? .....	470
[[:SENSe]:WAVEform: ACQuistion: PACKing AUTO   LONG   MEDIUM   SHORT .....	472
[[:SENSe]:WAVEform: ACQuistion: PACKing? .....	472
[[:SENSe]:WAVEform: ADC: DITHer[:STATe] OFF   ON   0   1 .....	472

---

# List of Commands

[:SENSe]:WAVeform:ADC:DITHer[:STATe]? . . . . .	472
[:SENSe]:WAVeform:ADC:FILTer[:STATe] OFF   ON   0   1 . . . . .	472
[:SENSe]:WAVeform:ADC:FILTer[:STATe]? . . . . .	472
[:SENSe]:WAVeform:ADC:RANGe AUTO   APEak   APLock   GROund   NONE   P0   P6   P12   P18 .	473
[:SENSe]:WAVeform:ADC:RANGe? . . . . .	473
[:SENSe]:WAVeform:APERture? . . . . .	473
[:SENSe]:WAVeform:AVERage:COUNT <integer> . . . . .	473
[:SENSe]:WAVeform:AVERage:COUNT? . . . . .	473
[:SENSe]:WAVeform:AVERage:TCONtrol EXPonential   REPEAT . . . . .	474
[:SENSe]:WAVeform:AVERage:TCONtrol? . . . . .	474
[:SENSe]:WAVeform:AVERage:TYPE LOG   MAXimum   MINimum   RMS   SCALar . . . . .	475
[:SENSe]:WAVeform:AVERage:TYPE? . . . . .	475
[:SENSe]:WAVeform:AVERage[:STATe] OFF   ON   0   1 . . . . .	474
[:SENSe]:WAVeform:AVERage[:STATe]? . . . . .	474
[:SENSe]:WAVeform:BANDwidth:RESolution]:ACTual? . . . . .	476
[:SENSe]:WAVeform:BANDwidth   BWIDth[:RESolution] <freq> . . . . .	475
[:SENSe]:WAVeform:BANDwidth   BWIDth[:RESolution]:TYPE FLATtop   GAUSSian . . . . .	476
[:SENSe]:WAVeform:BANDwidth   BWIDth[:RESolution]:TYPE? . . . . .	476
[:SENSe]:WAVeform:BANDwidth   BWIDth[:RESolution]? . . . . .	475
[:SENSe]:WAVeform:DECimate:STATe OFF   ON   0   1 . . . . .	477
[:SENSe]:WAVeform:DECimate:STATe? . . . . .	477
[:SENSe]:WAVeform:DECimate[:FACTor] <integer> . . . . .	476
[:SENSe]:WAVeform:DECimate[:FACTor]? . . . . .	476
[:SENSe]:WAVeform:SWEep:TIME <time> . . . . .	477
[:SENSe]:WAVeform:SWEep:TIME? . . . . .	477
[:SENSe]:WAVeform:TRIGger:SOURce EXTernal[1]   EXTernal2   FRAME   IF   IMMEDIATE   LINE   RFBurst . . . . .	477
[:SENSe]:WAVeform:TRIGger:SOURce? . . . . .	477

---

# 1 Understanding cdma2000

This chapter provides overall information about the cdma2000 communications system and describes cdma2000 measurements made by the analyzer. For further information, a list of associated documents is also provided.

---

## What Is the cdma2000 Communication System?

Code division multiple access 2000 (cdma2000) is a wideband CDMA standard that has been adopted by 3GPP2. It provides a wideband air interface for third generation global wireless communications systems. cdma2000 is a derivative of the IS-95-B CDMA system, also known as cdmaOne, and provides an upgrade path to support IMT-2000.

cdma2000 relies on the Global Positioning System (GPS) for intercell synchronization. Both reverse and forward transmitter power controls are implemented with 1.25 ms intervals. cdma2000 is a direct sequence spread-spectrum digital communications technique that supports wider RF bandwidths from 1.25 to 15 MHz. The main advantages of cdma2000 over other types of digital communication schemes are:

- greater capacity
- immunity to signal loss and degradation due to high-level broadband interference, multipath, and fading
- strict minimization of power consumption for mobile stations by both base station and mobile controls
- support for variable data rates; up to 144 kbits/second for mobile (vehicular) data rate, up to 384 kbits/second for portable (pedestrian) data rate, and up to 2 Mbits/second for fixed installations
- increased security

cdma2000 uses correlative codes to distinguish one user from another. Frequency division is still used, as is done with Frequency Division Multiple Access (FDMA) and Time Division Multiple Access (TDMA), but in a much larger bandwidth such as 1.25 MHz or greater. cdma2000 realizes increased capacity from 1:1 frequency reuse and sectorized cells. The capacity limit is soft. That is, capacity can be increased with some degradation of the error rate or voice quality.

In cdma2000, a single user's channel consists of a specific frequency combined with a unique Walsh code channel. Correlative Walsh codes allow each user to operate in the presence of substantial interference. The interference is the sum of all other users on the same cdma2000 frequency, both from within and outside of the home cell, and from delayed versions of these signals. It also includes the usual thermal noise and atmospheric disturbances. Delayed signals caused by multipath are separately received and combined in cdma2000. One of the major differences in access is that any cdma2000 frequency can be used in all sectors of all cells. This is possible because cdma2000 is designed to decode the proper signal in the presence of high interference.

Also, cdma2000 offers a number of RF structures to accommodate almost any conceivable application. These options include direct spreading to support those applications where clear spectrum is available and multi-carrier arrangements using 1.25 MHz wide channels to allow overlays with TIA/EIA-95-B systems.

cdma2000 is defined in the following Telecommunications Industry Association (TIA) and Electronics Industry Alliance (EIA) document:

TIA/EIA/IS-2000-1 through TIA/EIA/IS-2000-6

---

## What Does the Agilent PSA Series and VSA E4406A Option B78 Do?

This instrument can help determine if a cdma2000 transmitter is working correctly. The instrument automatically makes measurements using the measurement methods and limits defined in the 3GPP2 standards (For BTS: 3GPP2 C.S0010-A ver.3/30/2001, and for MS: 3GPP2 C.S0011-A ver.3/30/2001). For example, the documents include standardized test methods for the measurement of power in a carrier, a spectrum emission mask, intermodulation, and other critical measurements. The detailed results displayed by the measurements allow you to analyze cdma2000 system performance. You may alter the measurement parameters for specialized analysis.

For infrastructure test, the instrument will test base station transmitters in a non-interfering manner by means of a coupler or power splitter.

This instrument makes the following measurements:

- Channel Power
- Adjacent Channel Power Ratio (ACPR)
- Intermodulation
- Spectrum Emission Mask
- Occupied Bandwidth
- Code Domain Power
- Modulation Accuracy (Composite Rho)
- QPSK EVM
- Power Statistics CCDF
- Spectrum (Frequency Domain)
- Waveform (Time Domain)

---

## Other Sources of Measurement Information

Additional measurement application information is available through your local Agilent Technologies sales and service office. The following application notes treat digital communications measurements in much greater detail than discussed in this measurement guide.

- Application Note 1298  
Digital Modulation in Communications Systems - An Introduction  
Agilent part number 5965-7160E
- Application Note 1311  
Understanding CDMA Measurements for Base Stations and Their Components  
Agilent part number 5968-0953E
- Application Note 1325  
Performing cdma2000 Measurements Today  
Agilent part number 5968-5858E
- Application Note 1335  
HPSK Spreading for 3G  
Agilent part number 5968-8438E
- Application Note 1357  
Designing and Testing cdma2000 Base Stations  
Agilent part number 5980-1303E
- Application Note  
Characterizing Digitally Modulated Signals with CCDF Curves  
Agilent part number 5968-6875E

### Instrument Updates at <http://www.agilent.com>

This web location can be used to access the latest information about the instrument, including the latest firmware version.

<http://www.agilent.com/find/vsa>

<http://www.agilent.com/find/psa>





---

---

## 2

# Getting Started

This chapter introduces the basic features, including the front panel keys, and provides simplified procedures for making various measurements on cdma2000 BTS or MS equipment.

## Instrument Front Panel Highlights

The major functional keys on the front panel are located as illustrated below, and each of these operation is explained on the next page.

**Figure 2-1** E4406A Selected Front Panel Key Locations

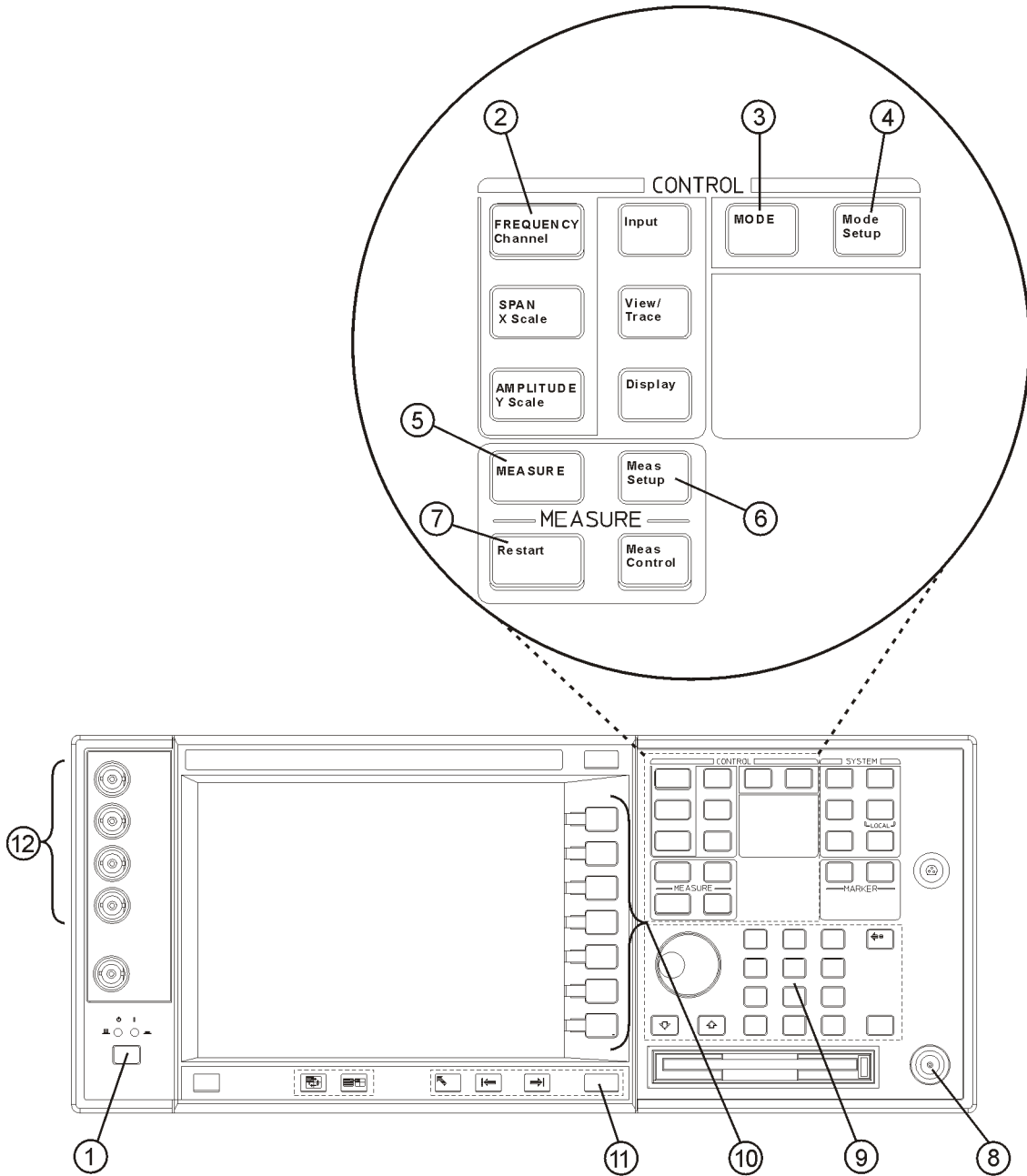

aa81a

Figure 2-2 PSA Selected Front Panel Key Locations

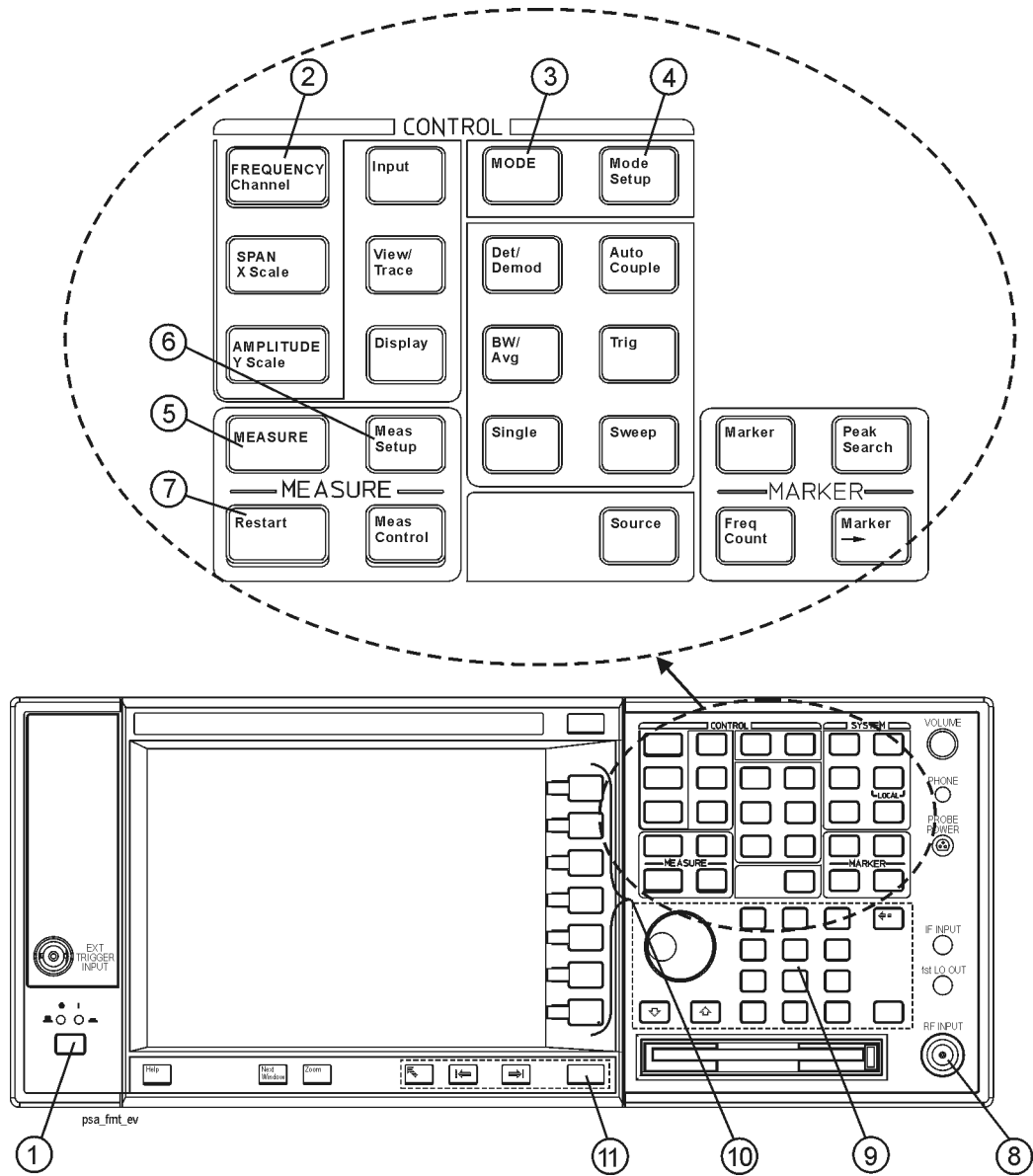

1. The **On/Off** switch toggles the power between on and off. A green LED will light when the instrument has been turned on. When energized in the standby mode a yellow LED is lit above the **On/Off** switch.
2. **FREQUENCY Channel** accesses the softkey that controls the center frequency or channel number. These parameters apply to all measurements in the current mode.
3. **MODE** accesses the softkey menu to select one of the radio systems installed in the instrument. Each mode is independent from all other modes.
4. **Mode Setup** accesses softkeys that affect parameters that are specific to the current mode and affect all measurements within that mode.
5. **MEASURE** accesses the menus to initiate one of the various measurements that are specific to the current mode.
6. **Meas Setup** accesses the menus of test parameters that are specific to the current measurement.
7. **Restart** causes the measurement, of which process is currently halted, to start again from the initial process according to the current measurement setup parameters.
8. The **RF INPUT** port allows you to apply an external RF signal.
9. The **Data Entry** keypad is used to enter numeric values to parameters. A value from this keypad will be displayed in the active function area of the screen, then the value will become valid for the current measurement upon pressing the **Enter** key or selecting a unit of measurement depending on the parameter.
10. The **Softkeys** allow you either to activate a feature or to access a further softkey menu. An arrow on the right side of a softkey label indicates that the key has a further selection menu. The active softkey is highlighted, however, grayed-out keys are currently unavailable for use or are only to show information. If a softkey menu has multiple pages, further pages will be accessed by pressing the **More** key which is placed at the bottom of a menu.
11. **Return** allows you to exit from the current menu and display the previous menu. If you are on the first page of a multiple-page menu (the menu with **More (1 of 3)** for example), the **Return** key will exit from that menu. When you activate another measurement, the return list is cleared. The **Return** key will not return you to the previously activated mode, nor will it alter any values you have entered on previous menus.
12. **Baseband I/Q Inputs (E4406A Option B7C)** allow you to analyze signals using selected digital modulation formats at baseband frequencies. Not available for use with Option B78.

## Making a Measurement

This instrument enables you to make a wide variety of measurements on digital communications equipment using the **Basic Mode** (for E4406A), or the **Spectrum Analysis Mode** (for PSA) measurement capabilities. It also has optional measurement personalities that make measurements based on established industry standards.

To set up the instrument to make measurements, you need to:

1. Press **MODE** to select a personality which corresponds to a digital communications format, like cdma2000, W-CDMA, or EDGE. Or use the Basic mode to make measurements on signals with non-standard formats. After selecting the mode, make any required adjustments to the mode settings by pressing **Mode Setup**.
2. Press **MEASURE** to select a specific measurement to be performed, like ACP, Channel Power, or EVM, and so forth. After selection of your measurement, make any required adjustments to the measurement settings by pressing **Meas Setup**.

Depending on the current settings of **Meas Control**, the instrument will begin making the selected measurements. The resulting data will be shown on the display or available for export.

3. Press **Trace/View** to display the data from the current measurement. Depending on the mode and measurement selected, various graphical and tabular presentations are available.

The main keys used in the three steps are shown in the table below.

Step	Primary Key	Setup Keys	Related Keys
1. Select & setup a mode	<b>MODE</b>	<b>Mode Setup, Input (E4406A), Input/Output (PSA), FREQUENCY Channel</b>	<b>System</b>
2. Select & setup a measurement	<b>MEASURE</b>	<b>Meas Setup</b>	<b>Meas Control, Restart</b>
3. Select & setup a view	<b>View/Trace (E4406A), Trace/View (PSA)</b>	<b>SPAN X Scale, AMPLITUDE Y Scale, Display, Next Window, Zoom</b>	<b>File, Save, Print, Print Setup, Marker, Search (E4406A), Peak Search (PSA)</b>

A setting may be reset at any time, and will be in effect on the next measurement cycle or View.

## Start Making Channel Power Measurements

This section explains how to make a channel power measurement on a cdma2000 mobile station. This test measures the total RF power present in the channel. The results are displayed graphically as well as in total power (dB) and power spectral density (dBm/Hz).

### Configuring the Measurement System

The mobile station (MS) under test has to be set to transmit the RF power remotely through the system controller. This transmitting signal is connected to the instruments RF input port. Connect the equipment as shown.

Figure 2-3 Channel Power Measurement System

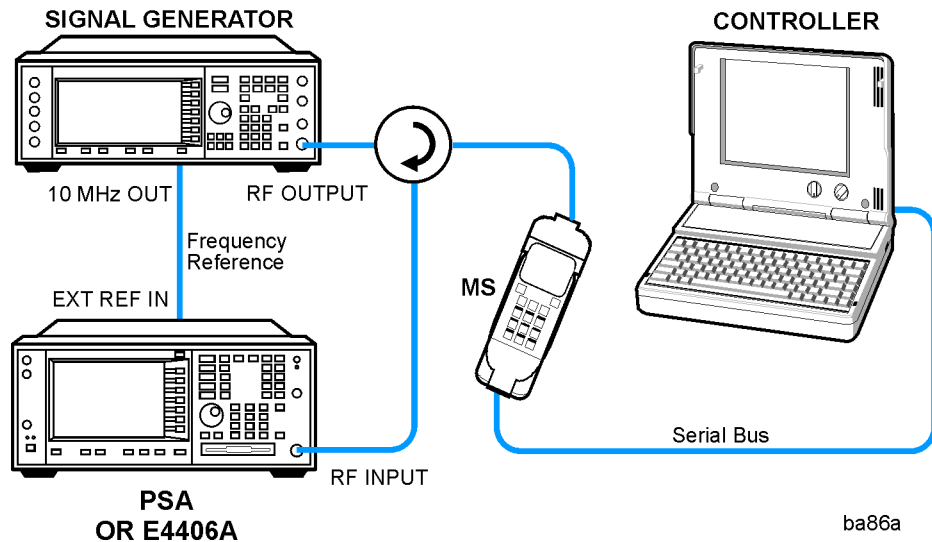

1. Using the appropriate cables, adapters, and circulator, connect the output signal from the MS to the RF input port of the instrument.
2. Connect the base transmission station simulator or signal generator to the MS through a circulator to initiate a link constructed with the sync and pilot channels, if required.
3. Connect a BNC cable between the 10 MHz OUT port of the signal generator and the EXT REF IN port of the instrument.
4. Connect the system controller to the MS through the serial bus cable to control the MS operation.

### Setting Up the MS

From the base transmission station simulator and the system controller, set up a call using Rate Set 1 Fundamental Code Channel

loopback mode (Service Option 2) with 9600 bps data rate only required for the MS to transmit the RF power as follows:

MS: Band Class 1, Block Designator A, Class III  
 Frequency: 1855.000 MHz (preferred set channel number 100)  
 (=  $100 \times 0.050 + 1850.000$  MHz)  
 Output Power: -3 dBW (0.5 W) controlled by '0' power control bits

## Measurement Procedure

- Step 1.** Press the **Preset** key to preset the instrument.
- Step 2.** Press the **System, Reference, Freq Ref** keys to toggle the frequency reference to EXT, if required. In the annunciator bar you will see EXT REF displayed in green.
- Step 3.** Press the **MODE, More (1 of 2), cdma2000** keys to enable the cdma2000 measurements.
- Step 4.** Press the **Mode Setup, Radio, Device** to toggle the device to MS.
- Step 5.** Press the **FREQUENCY Channel, 1855, MHz** keys to set the center frequency to 1,855.000 MHz.
- Step 6.** Press the **MEASURE, Channel Power** keys to initiate the channel power measurement.

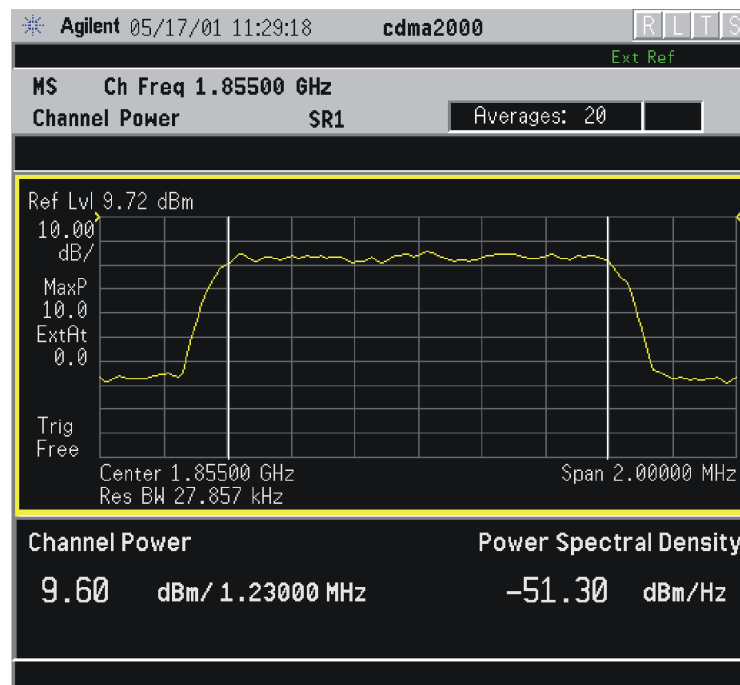

The Channel Power measurement result should look like the above figure. The graph window and the text window showing the absolute power and its mean power spectral density values are displayed.

**Step 7.** Press the **Meas Setup, More (1 of 2)** keys to check the keys available to change the measurement parameters from the default condition.

If you have a problem, and get an error message, see [“If You Have a Problem”](#) on page 70.



## Start Making ACPR Measurements

This section explains how to make an adjacent channel power ratio (ACPR) measurement on a cdma2000 mobile station. ACPR is a measurement of the amount of interference, or power, in an adjacent frequency channel. The results are displayed as a bar graph or as spectrum data, along with measurement data at specified offsets.

### Configuring the Measurement System

The mobile station (MS) under test has to be set to transmit the RF power remotely through the system controller. This transmitting signal is connected to the instruments RF input port. Connect the equipment as shown.

**Figure 2-4** Adjacent Channel Power Ratio Measurement System

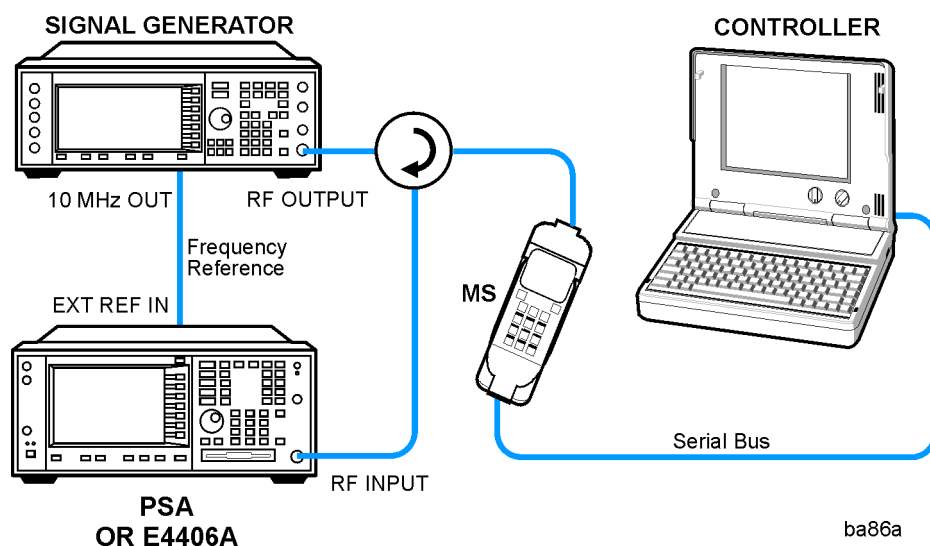

1. Using the appropriate cables, adapters, and circulator, connect the output signal from the MS to the RF input port of the instrument.
2. Connect the base transmission station simulator or signal generator to the MS through a circulator to initiate a link constructed with the sync and pilot channels, if required.
3. Connect a BNC cable between the 10 MHz OUT port of the signal generator and the EXT REF IN port of the instrument.
4. Connect the system controller to the MS through the serial bus cable to control the MS operation.

### Setting the MS

From the base transmission station simulator and the system

controller, set up a call using Rate Set 1 Fundamental Code Channel loopback mode (Service Option 2) with 9600 bps data rate only required for the MS to transmit the RF power as follows:

MS: Band Class 1, Block Designator A, Class III  
 Frequency: 1855.000 MHz (preferred set channel number 100)  
 (= 100 × 0.050 + 1850.000 MHz)  
 Output Power: -3 dBW (0.5 W) controlled by '0' power control bits

## Measurement Procedure

- Step 1.** Press the **Preset** key to preset the instrument.
- Step 2.** Press the **MODE, More (1 of 2), cdma2000** keys to enable the cdma2000 measurements.
- Step 3.** Press the **Mode Setup, Radio, Device** to toggle the device to **MS**.
- Step 4.** Press the **FREQUENCY Channel, 1855, MHz** keys to set the center frequency to 1,855.000 MHz.
- Step 5.** Press the **MEASURE, ACPR** keys to initiate the adjacent channel leakage power ratio measurement.

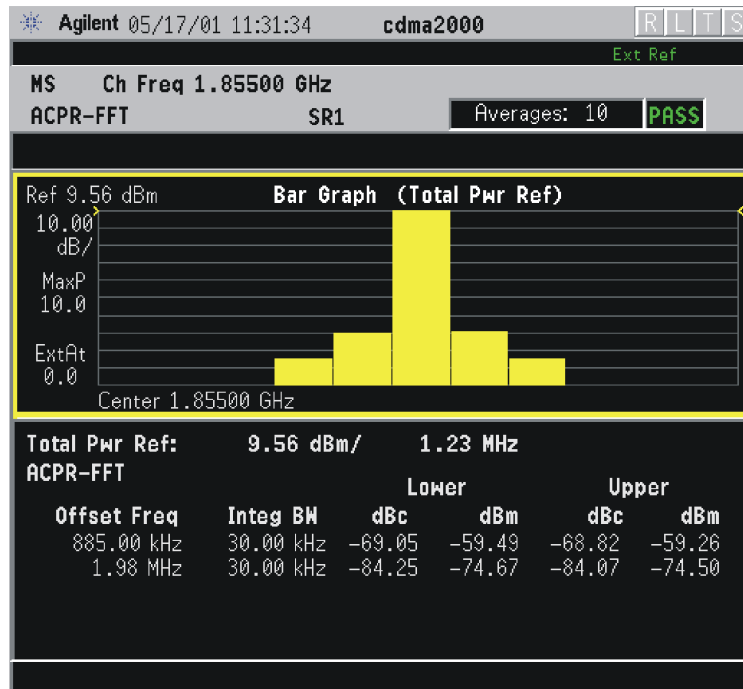

The ACPR-FFT Bar Graph measurement result should look like the above figure. The bar graph (referenced to the total power) and a text window are displayed. The text window shows the absolute total power reference, while the lower and upper offset channel power levels are displayed in both absolute and relative readings.

**Step 6.** Press the **View/Trace, Spectrum** keys to see the ACPR-FFT: Spectrum graph with the bandwidth marker lines in the graph window. The corresponding measured data are also shown in the text window.

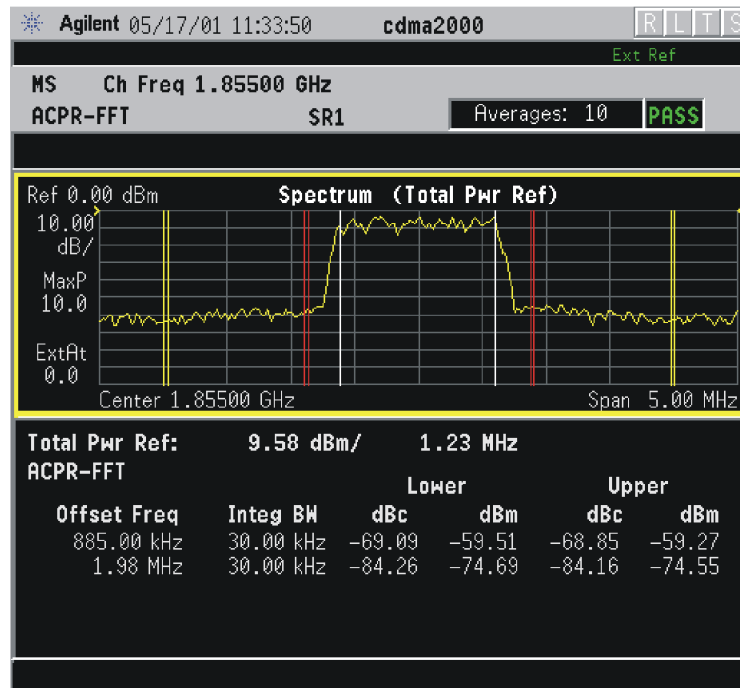

**Step 7.** Press the **Meas Setup, More (1 of 2), Sweep Type** keys to select **Swp**. The ACPR-SWP: Spectrum measurement speed is slower with the narrower resolution bandwidth, but the measurement accuracy is improved.

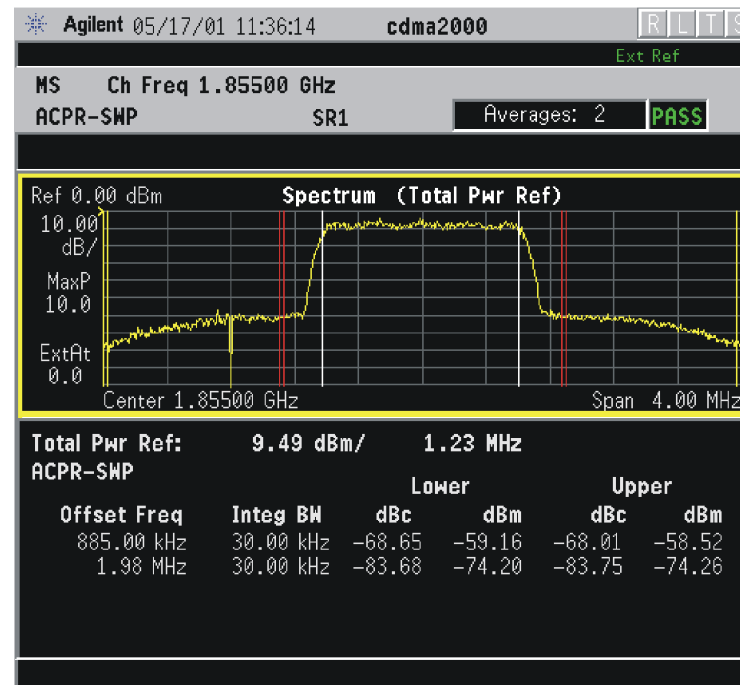

**Step 8.** Press the **Meas Setup, More (2 of 2)** keys to check the keys available to change the measurement parameters from the default condition.

Getting Started  
Start Making ACPR Measurements

If you have a problem, and get an error message, see [“If You Have a Problem”](#) on page 70.

## Start Making Intermodulation Measurements

This section explains how to measure cdma2000 intermodulation products. The instrument, by default, measures the third- and fifth-order intermodulation products of the base frequency signal. Either two-tone or transmit intermodulation products are automatically identified.

### Configuring the Measurement System

The base transmission station (BTS) under test has to be set to transmit the RF power remotely through the system controller. The cdma2000 modulated interference signal is injected at the antenna output port of the BTS through an amplifier and circulator. The transmitting signal from the BTS is summed with the interferer and connected to the instruments RF input port. Connect the equipment as shown.

Figure 2-5

### Intermodulation Product Measurement System

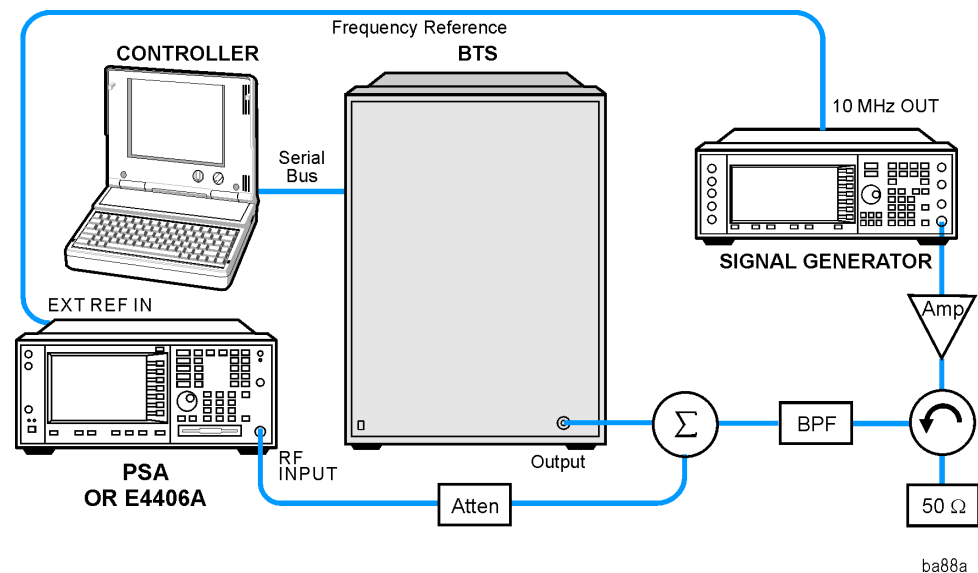

1. Using appropriate amplifier, circulators, etc., connect a cdma2000 carrier interference signal to the output connector of the BTS.
2. Connect the circulator output signal to the RF input port of the instrument through an attenuator.
3. Connect a BNC cable between the 10 MHz OUT port of the signal generator and the EXT REF IN port of the instrument.
4. Connect the system controller to the BTS with the serial bus cable.

## Setting the BTS and Signal Generator

From the system controller, perform all of the functions required for the BTS to transmit the RF signal. Also set the signal generator to output the 3 MHz offset carrier signal to make an intermodulation measurement with the transmit IM and tone signals.

- **BTS (transmit intermodulation signal)**
  - Frequency: 1,935.000 MHz (preferred set channel number 100)  
(=  $100 \times 0.050 + 1930.000$  MHz)
  - Output Power: Specified maximum output power level
- **Signal Generator (interference carrier signal)**
  - Frequency: 1,938.000 MHz (= 160 channel number)
  - Signal: CW (unmodulated carrier)
  - Output Power: Same level to the BTS output power at the BTS antenna output port

## Measurement Procedure

- Step 1.** Press the **Preset** key to preset the instrument.
- Step 2.** Press the **Mode, More (1 of 2), cdma2000** keys to enable the cdma2000 measurements.
- Step 3.** Press the **Mode Setup, Radio, Device** to toggle to **BTS**.
- Step 4.** Press the **FREQUENCY Channel, 1935, MHz** keys to set the center frequency to 1,935.000 MHz.
- Step 5.** Press the **MEASURE, Intermod** keys to initiate the intermodulation

measurement.

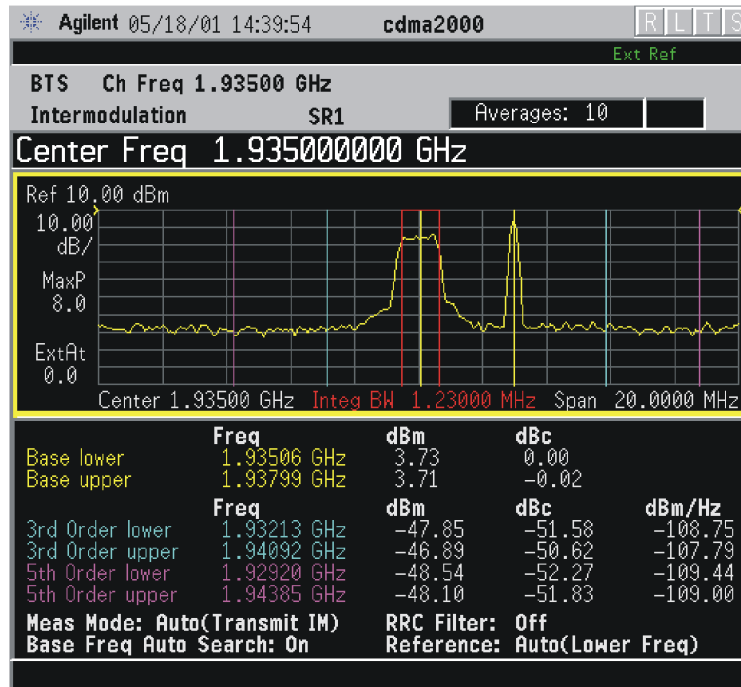

The Intermodulation measurement result should look like the above figure. The intermodulation products are graphically displayed in the graph window. The absolute and relative power levels along with the lower and upper power spectral density levels are shown in the text window.

**Step 6.** Press the **Meas Setup, More (1 of 2)** keys to check the keys available to change the measurement parameters from the default condition.

If you have a problem, and get an error message, see [“If You Have a Problem”](#) on page 70.

## Start Making Spectrum Emission Mask Measurements

This section explains how to make a spectrum emission mask measurement (SEM) on a cdma2000 mobile station. SEM compares the total power level within the defined carrier bandwidth and the given offset channels on both sides of the carrier frequency to levels allowed by the standard. Results of the measurement of each offset segment are viewable separately.

### Configuring the Measurement System

The mobile station (MS) under test has to be set to transmit the RF power remotely through the system controller. This transmitting signal is connected to the instruments RF input port. Connect the equipment as shown.

**Figure 2-6** Spectrum Emission Mask Measurement System

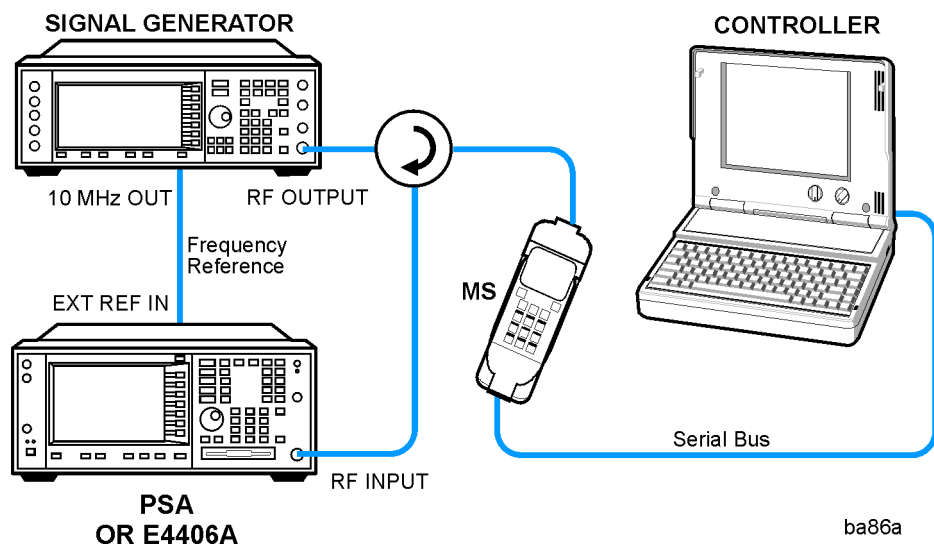

1. Using the appropriate cables, adapters, and circulator, connect the output signal from the MS to the RF input port of the instrument.
2. Connect the base transmission station simulator or signal generator to the MS through a circulator to initiate a link constructed with the sync and pilot channels, if required.
3. Connect a BNC cable between the 10 MHz OUT port of the signal generator and the EXT REF IN port of the instrument.
4. Connect the system controller to the MS through the serial bus cable to control the MS operation.



## Setting the MS

From the base transmission station simulator and the system controller, set up a call using Rate Set 1 Fundamental Code Channel loopback mode (Service Option 2) with 9600 bps data rate only required for the MS to transmit the RF power as follows:

MS: Band Class 1, Block Designator A, Class III  
 Frequency: 1855.000 MHz (preferred set channel number 100)  
 (= 100 × 0.050 + 1850.000 MHz)  
 Output Power: -3 dBW (0.5 W) controlled by '0' power control bits

## Measurement Procedure

- Step 1.** Press the **Preset** key to preset the instrument.
- Step 2.** Press the **MODE, More (1 of 2), cdma2000** keys to enable the cdma2000 measurements.
- Step 3.** Press the **Mode Setup, Radio, Device** to toggle the device to **MS**.
- Step 4.** Press the **FREQUENCY Channel, 1855, MHz** keys to set the center frequency to 1,855.000 MHz.
- Step 5.** Press the **MEASURE, Spectrum Emission Mask** keys to initiate the spectrum emission mask measurement.

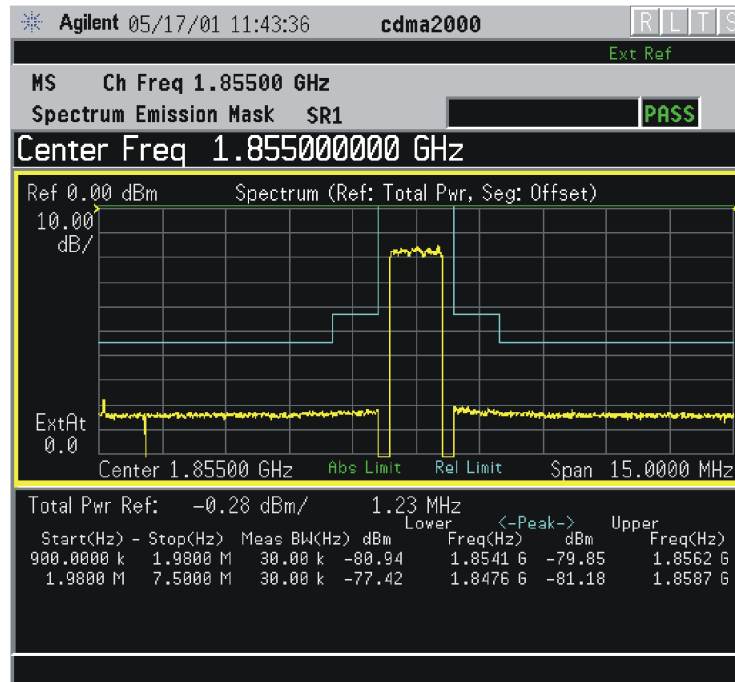

The Spectrum Emission Mask: Spectrum (Ref: Total Pwr, Seg: Offset) result should look like the above figure. The graph window and a text window are displayed. The text window shows the reference

total power and the absolute peak power levels which correspond to the frequency bands on both sides of the reference channel.

- Step 6.** Press the **Meas Setup, Spectrum Segment** keys to toggle to Region. The Spurious Emission: Spectrum (Ref: Total Pwr, Seg: Region) measurement result should look like the next figure.

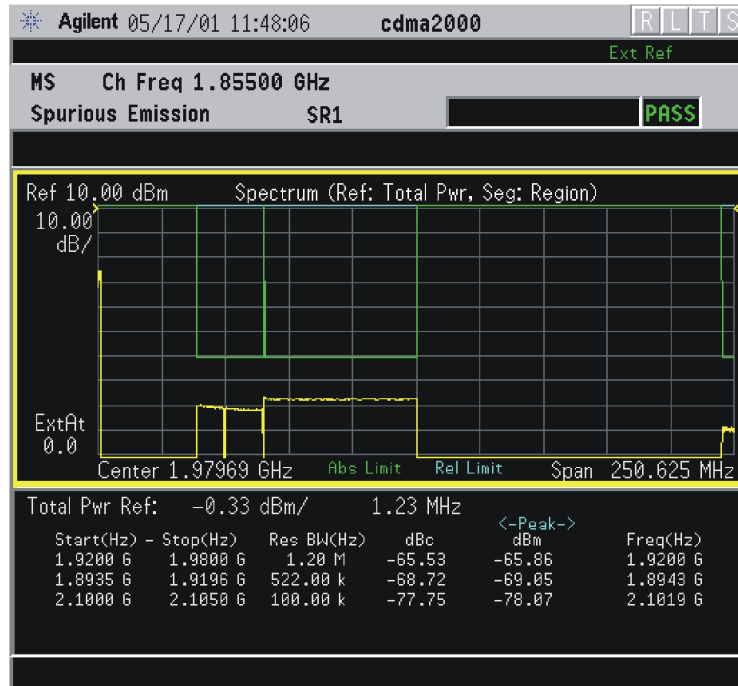

- Step 7.** Press the **Meas Setup, More (1 of 2)** keys to check the keys available to change the measurement parameters from the default condition.

If you have a problem, and get an error message, see [“If You Have a Problem”](#) on page 70.

## Start Making Occupied Bandwidth Measurements

This section explains how to make an occupied bandwidth measurement on a cdma2000 mobile station. The tester measures power across the band, and then calculates its 99.0% power bandwidth.

### Configuring the Measurement System

The mobile station (MS) under test has to be set to transmit the RF power remotely through the system controller. This transmitting signal is connected to the instruments RF input port. Connect the equipment as shown.

**Figure 2-7** Occupied Bandwidth Measurement System

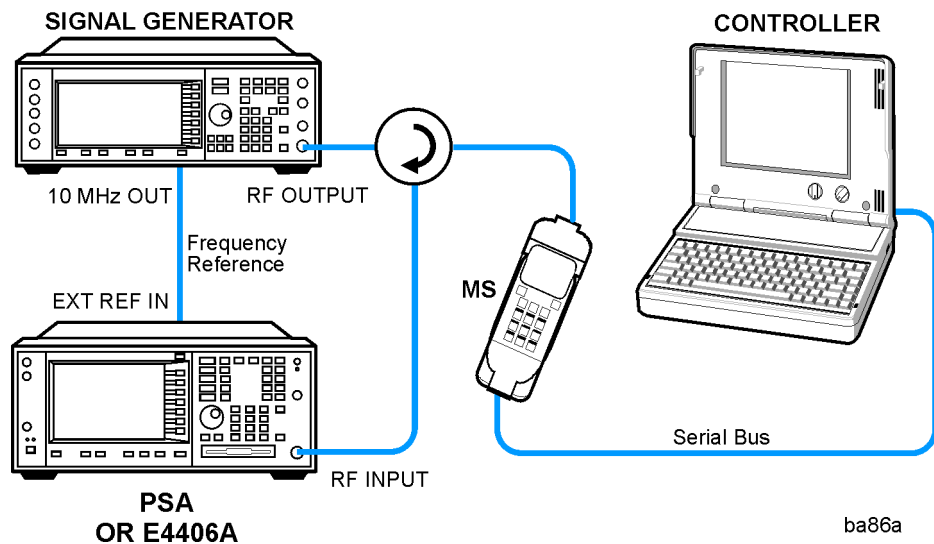

1. Using the appropriate cables, adapters, and circulator, connect the output signal of the MS to the RF input of the instrument.
2. Connect the base transmission station simulator or signal generator to the MS through a circulator to initiate a link constructed with sync and pilot channels, if required.
3. Connect a BNC cable between the 10 MHz OUT port of the signal generator and the EXT REF IN port of the instrument.
4. Connect the system controller to the MS through the serial bus cable to control the MS operation.

### Setting the MS

From the base transmission station simulator and the system

controller, set up a call using Rate Set 1 Fundamental Code Channel loopback mode (Service Option 2) with 9600 bps data rate only required for the MS to transmit the RF power as follows:

- MS: Band Class 1, Block Designator A, Class III
- Frequency: 1855.000 MHz (preferred set channel number 100)  
(=  $100 \times 0.050 + 1850.000$  MHz)
- Output Power: -3 dBW (0.5 W) controlled by '0' power control bits

### Measurement Procedure

- Step 1.** Press the **Preset** key to preset the instrument.
- Step 2.** Press the **MODE, More (1 of 2), cdma2000** keys to enable the cdma2000 measurements.
- Step 3.** Press the **Mode Setup, Radio, Device** to toggle the device to **MS**.
- Step 4.** Press the **FREQUENCY Channel, 1855, MHz** keys to set the center frequency to 1,855.000 MHz.
- Step 5.** Press the **MEASURE, Occupied BW** keys to initiate the occupied bandwidth measurement.

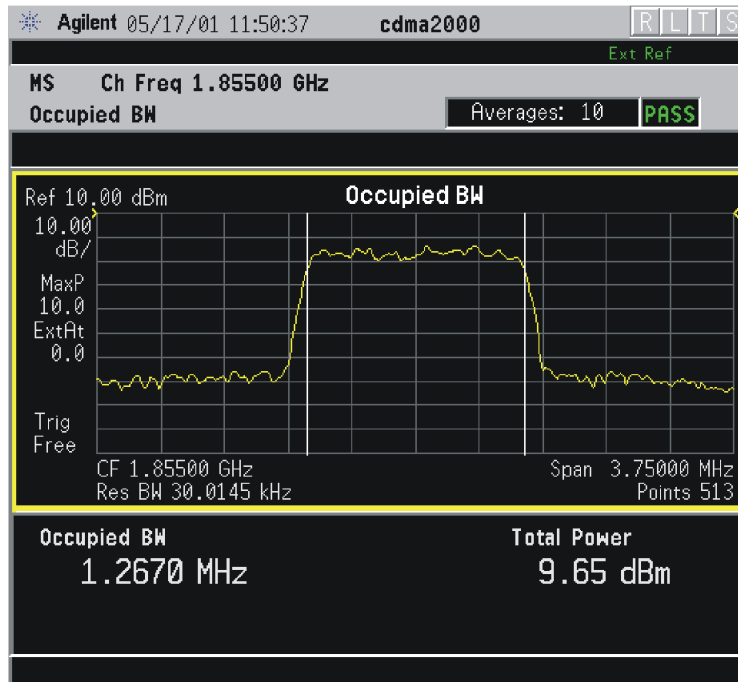

The Occupied BW measurement result should look like the above figure. A graph window with text showing the occupied bandwidth and the absolute total power level are displayed.

- Step 6.** Press the **Meas Setup, More (1 of 2)** keys to check the keys available to change the measurement parameters from the default condition.

If you have a problem, and get an error message, see [“If You Have a Problem”](#) on page 70.

## Start Making Code Domain Measurements

This section explains how to make a code domain measurement on a cdma2000 mobile station. This is the measurement of the power levels of the spread channels in composite RF channels, relative to the total power within the 3.840 MHz channel bandwidth centered at the center frequency.

### Configuring the Measurement System

The mobile station (MS) under test has to be set to transmit the RF power remotely through the system controller. This transmitting signal is connected to the instrument's RF input port. Connect the equipment as shown.

**Figure 2-8** Code Domain Power Measurement System

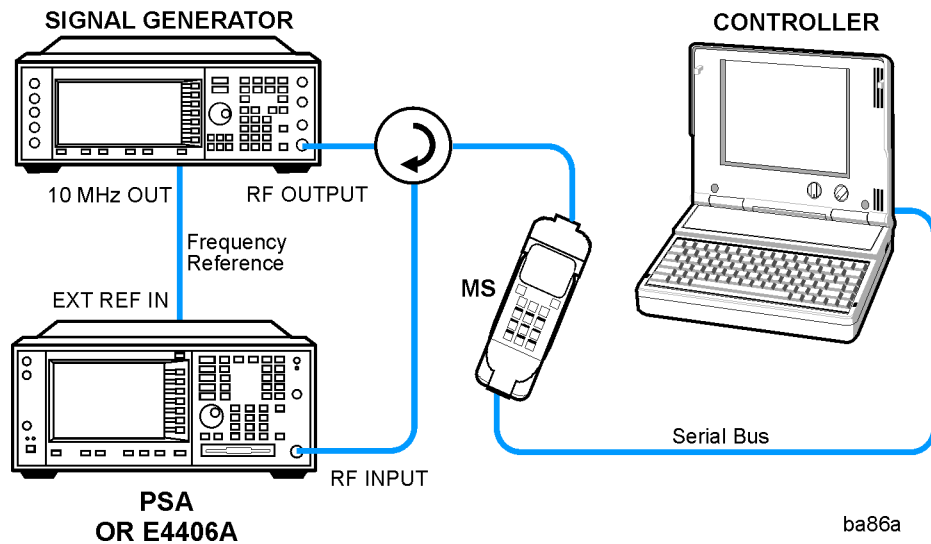

1. Using the appropriate cables, adapters, and circulator, connect the output signal of the MS to the RF input of the instrument.
2. Connect the base transmission station simulator or signal generator to the MS through a circulator to initiate a link constructed with sync and pilot channels, if required.
3. Connect a BNC cable between the 10 MHz OUT port of the signal generator and the EXT REF IN port of the instrument.
4. Connect the system controller to the MS through the serial bus cable to control the MS operation.

## Setting the MS

From the base transmission station simulator and the system controller, set up a call using Rate Set 1 Fundamental Code Channel loopback mode (Service Option 2) with 9600 bps data rate only required for the MS to transmit the RF power as follows:

MS: Band Class 1, Block Designator A, Class III  
 Long Code Mask 0000000000  
 Frequency: 1855.000 MHz (preferred set channel number 100)  
 (=  $100 \times 0.050 + 1850.000$  MHz)  
 Output Power: -3 dBW (0.5 W) controlled by '0' power control bits

## Measurement Procedure

- Step 1.** Press the **Preset** key to preset the instrument.
- Step 2.** Press the **MODE, More (1 of 2), cdma2000** keys to enable the cdma2000 measurements.
- Step 3.** Press the **Mode Setup, Radio, Device** to toggle the device to **MS**.
- Step 4.** Press the **FREQUENCY Channel, 1855, MHz** keys to set the center frequency to 1,855.000 MHz.
- Step 5.** Press the **MEASURE, More (1 of 2), Code Domain, Meas Setup, More (1 of 3), Long Code Mask, 0000000000** keys to initiate the code domain measurement.

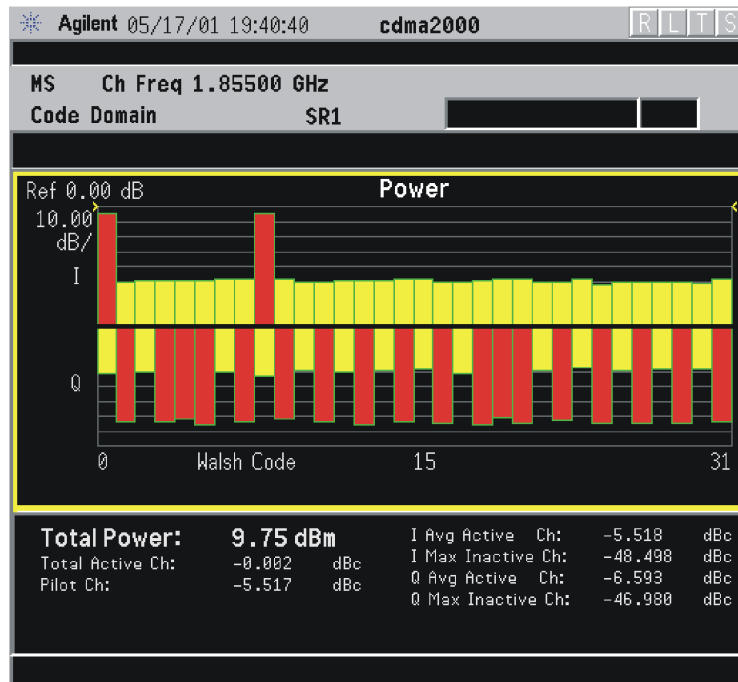

The Code Domain: Power measurement result should look like the

above figure. The graph window and a text window is displayed. The text window shows the total power level along with the relative power levels of the various channels.

- Step 6.** Press the **View/Trace, I/Q Error (Quad View)** keys to display a combination view of the magnitude error, phase error, EVM graph windows, and the modulation summary results window as shown below:

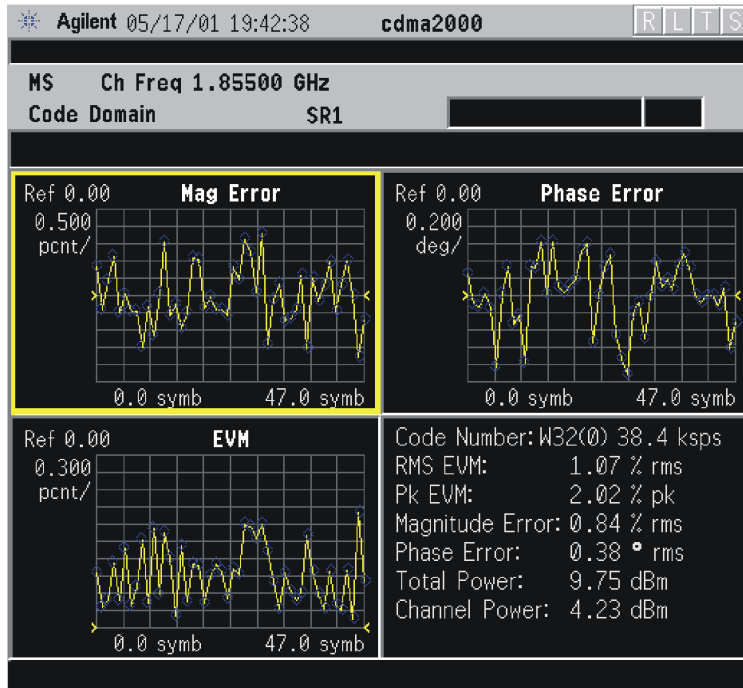

- Step 7.** Press the **Code Domain (Quad View)** key to display a combination view of the code domain power, symbol power, and I/Q symbol polar vector graph windows, and the code domain summary results window as



shown below:

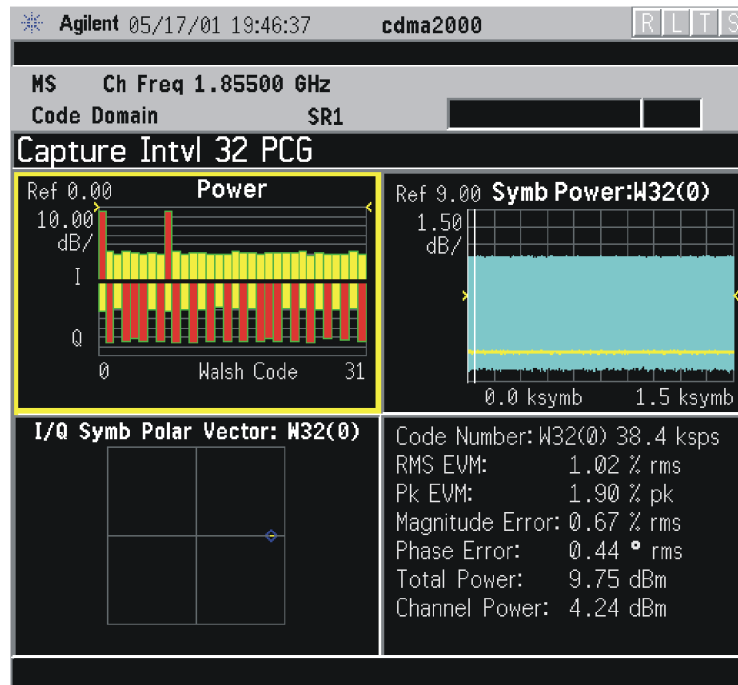

**Step 8.** Press the **Demod Bits** key to display a combination view of the code domain power, symbol power graph windows, and the I/Q demodulated bit stream data for the symbol power slots selected by the measurement interval and measurement offset parameters.

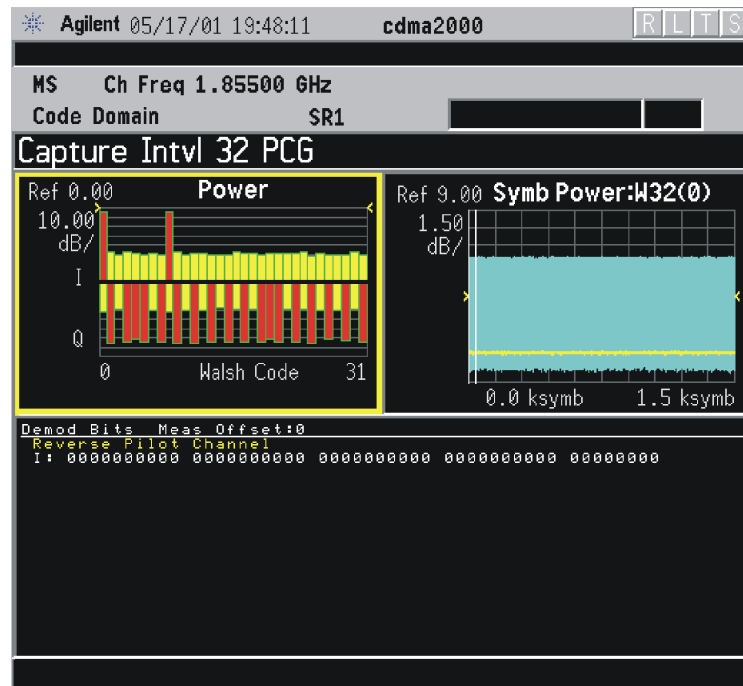

**Step 9.** To make a measurement repeatedly, press **Meas Control**, **Measure** to toggle the setting from **Single** to **Cont**.

**Step 10.** Press the **Meas Setup**, **More (1 of 3)**, **More (2 of 3)** keys to check the keys available to change the measurement parameters from the default condition.

If you have a problem, and get an error message, see [“If You Have a Problem” on page 70](#).

## Start Making Modulation Accuracy (Composite Rho) Measurements

This section explains how to make a modulation accuracy (composite Rho) measurement on a cdma2000 mobile station. Rho is the ratio of the correlated power in a multi coded channel to the total signal power.

### Configuring the Measurement System

The mobile station (MS) under test has to be set to transmit the RF power remotely through the system controller. This transmitting signal is connected to the instruments RF input port. Connect the equipment as shown.

**Figure 2-9** Modulation Accuracy Measurement System

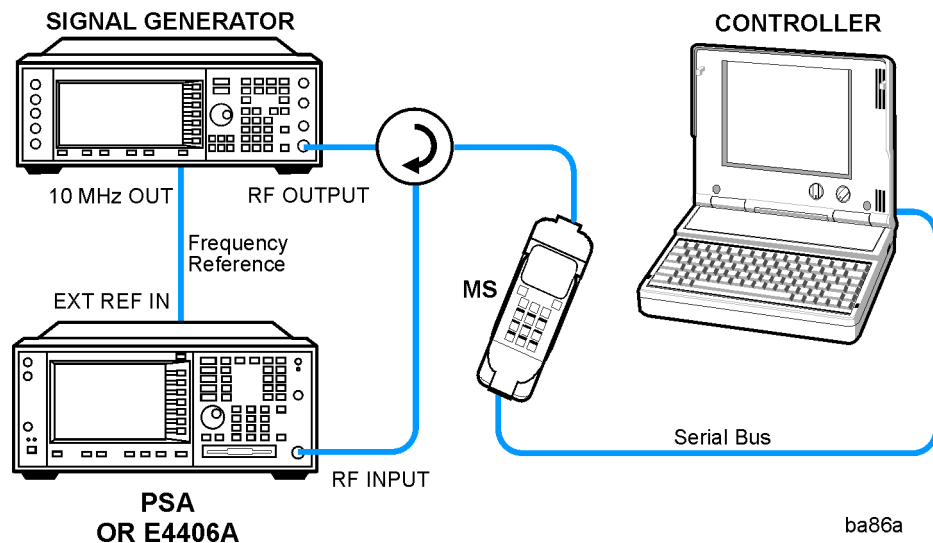

1. Using the appropriate cables, adapters, and circulator, connect the output signal of the MS to the RF input of the instrument.
2. Connect the base transmission station simulator or signal generator to the MS through a circulator to initiate a link constructed with sync and pilot channels, if required.
3. Connect a BNC cable between the 10 MHz OUT port of the signal generator and the EXT REF IN port of the instrument.
4. Connect the system controller to the MS through the serial bus cable to control the MS operation.

### Setting the MS

From the base transmission station simulator and the system

controller, set up a call using Rate Set 1 Fundamental Code Channel loopback mode (Service Option 2) with 9600 bps data rate only required for the MS to transmit the RF power as follows:

MS: Band Class 1, Block Designator A, Class III

Long Code Mask 000000000

Frequency: 1855.000 MHz (preferred set channel number 100)  
(=  $100 \times 0.050 + 1850.000$  MHz)

Output Power: -3 dBW (0.5 W) controlled by '0' power control bits

## Measurement Procedure

- Step 1.** Press the **Preset** key to preset the instrument.
- Step 2.** Press the **MODE, More (1 of 2), cdma2000** keys to enable the cdma2000 measurements.
- Step 3.** Press the **Mode Setup, Radio, Device** to toggle the device to **MS**.
- Step 4.** Press the **FREQUENCY Channel, 1855, MHz** keys to set the center frequency to 1,855.000 MHz.
- Step 5.** Press the **MEASURE, More (1 of 2), Mod Accuracy (Composite Rho), Meas Setup, More (1 of 2), Long Code Mask, 000000000** keys to initiate the measurement.

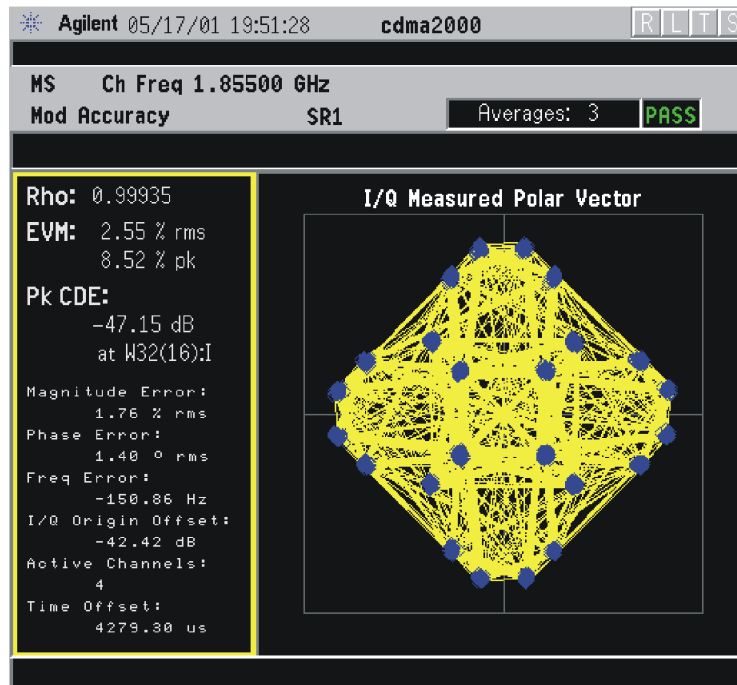

The Mod Accuracy: I/Q Measured Polar Vector measurement result should look like the above figure. The measurement values for modulation accuracy are shown in the summary result window.

**Step 6.** Press the **View/Trace, I/Q Measured Polar Constn** keys to display a combination view of the I/Q measured polar constellation graph window and the modulation summary result window.

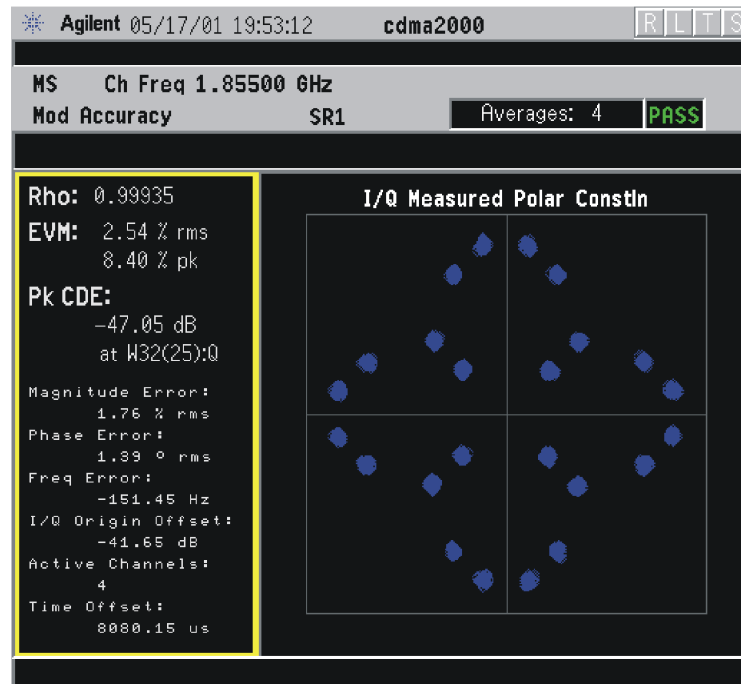

**Step 7.** Press the **View/Trace, I/Q Error (Quad View)** keys to display a combination view of the magnitude error, phase error, and EVM graph windows, and the modulation summary result window.

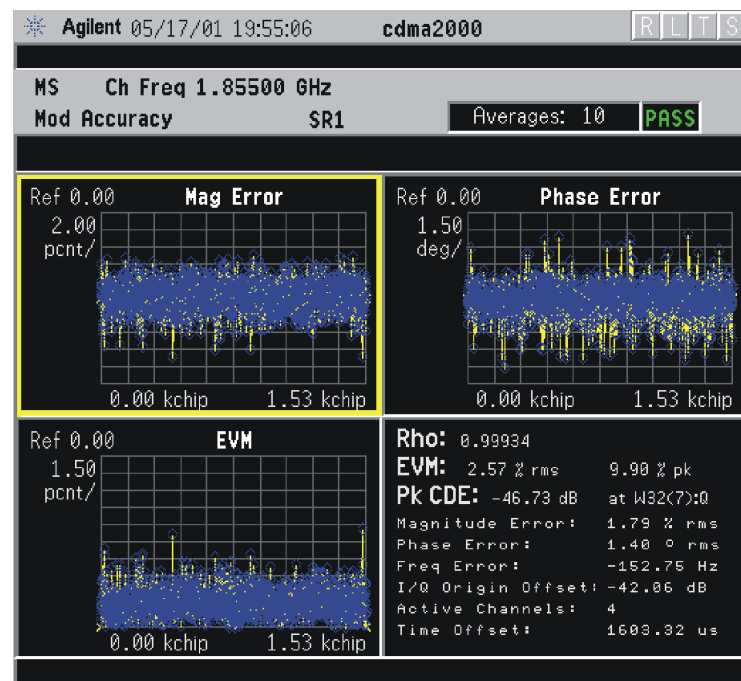

**Step 8.** Press the **Meas Setup, More (1 of 2)** keys to check the keys available to change the measurement parameters from the default condition.

Getting Started

**Start Making Modulation Accuracy (Composite Rho) Measurements**

If you have a problem, and get an error message, see [“If You Have a Problem”](#) on page 70.

## Start Making QPSK EVM Measurements

This section explains how to make a quadrature phase shift keying (QPSK) error vector magnitude (EVM) measurement on a cdma2000 mobile station. QPSK EVM is a measure of phase and amplitude modulation quality that relates the performance of the actual signal compared to an ideal signal as a percentage, as calculated over the course of the ideal constellation.

### Configuring the Measurement System

The mobile station (MS) under test has to be set to transmit the RF power remotely through the system controller. This transmitting signal is connected to the instruments RF input port. Connect the equipment as shown.

**Figure 2-10** QPSK EVM Measurement System

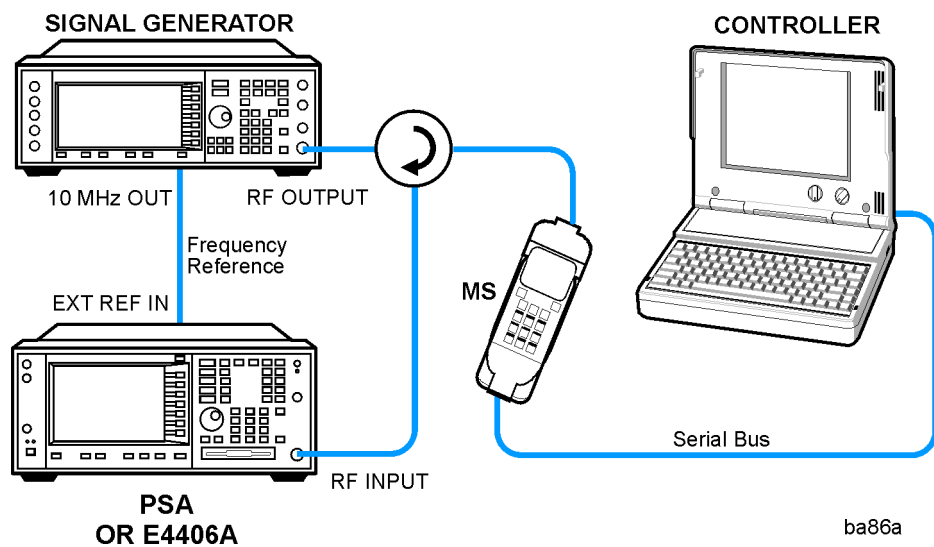

1. Using the appropriate cables, adapters, and circulator, connect the output signal of the MS to the RF input of the instrument.
2. Connect the base transmission station simulator or signal generator to the MS through a circulator to initiate a link constructed with sync and pilot channels, if required.
3. Connect a BNC cable between the 10 MHz OUT port of the signal generator and the EXT REF IN port of the instrument.
4. Connect the system controller to the MS through the serial bus cable to control the MS operation.

## Setting the MS

From the base transmission station simulator and the system controller, set up a call using Rate Set 1 Fundamental Code Channel loopback mode (Service Option 2) with 9600 bps data rate only required for the MS to transmit the RF power as follows:

MS: Band Class 1, Block Designator A, Class III  
Frequency: 1855.000 MHz (preferred set channel number 100)  
(=  $100 \times 0.050 + 1850.000$  MHz)  
Output Power: -3 dBW (0.5 W) controlled by '0' power control bits

## Measurement Procedure

- Step 1.** Press the **Preset** key to preset the instrument.
- Step 2.** Press the **MODE, More (1 of 2), cdma2000** keys to enable the cdma2000 measurements.
- Step 3.** Press the **Mode Setup, Radio, Device** to toggle the device to **MS**.
- Step 4.** Press the **FREQUENCY Channel, 1855, MHz** keys to set the center frequency to 1855.000 MHz.
- Step 5.** Press the **MEASURE, More (1 of 2), QPSK EVM** keys to set the instrument to initiate the QPSK EVM measurement.

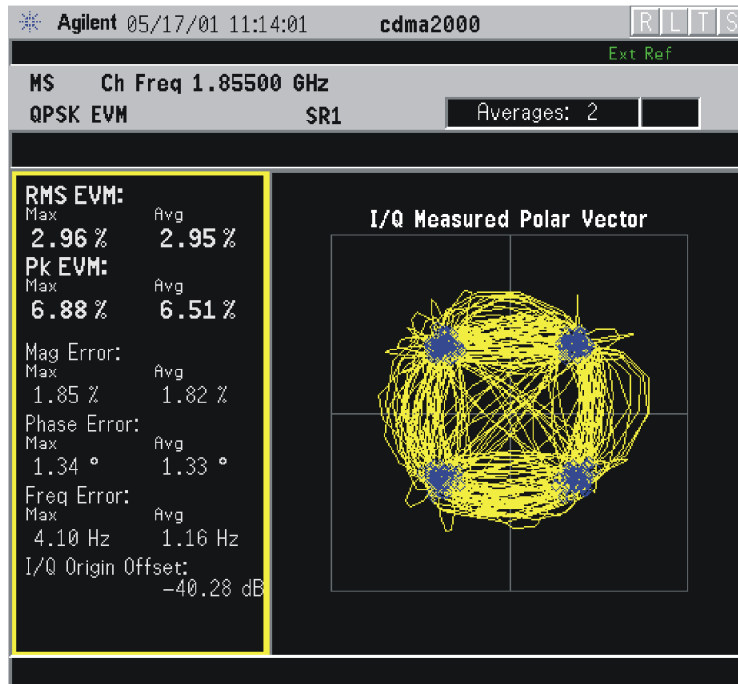

The QPSK EVM: I/Q Measured Polar Vector measurement result should look like the above figure. The measurement values for modulation accuracy are shown in the summary result window.



**Step 6.** Press the **View/Trace, I/Q Measured Polar Constln** keys to display a combination view of the I/Q measured polar constellation graph window and the modulation summary result window.

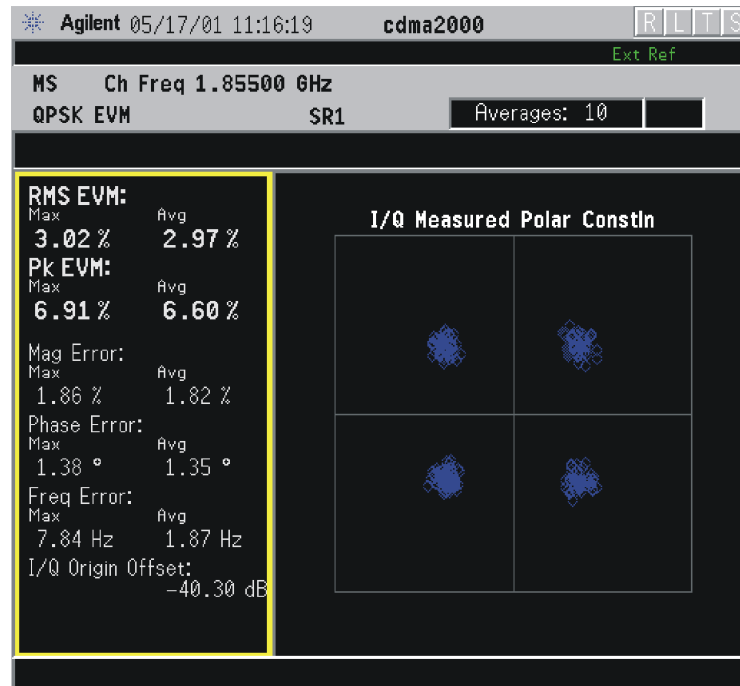

**Step 7.** Press the **View/Trace, I/Q Error (Quad View)** keys to display a combination view of the magnitude error, phase error, and EVM graph windows, and the modulation summary result window.

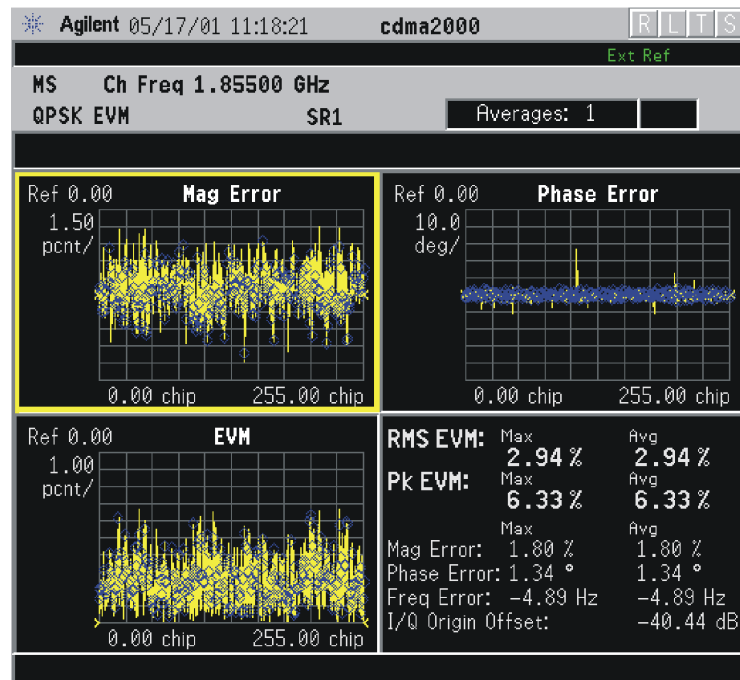

**Step 8.** Press the **Meas Setup, More (1 of 2)** keys to check the keys available to

Getting Started  
**Start Making QPSK EVM Measurements**

change the measurement parameters from the default condition.

If you have a problem, and get an error message, see [“If You Have a Problem”](#) on page 70.

## Start Making Power Stat CCDF Measurements

This section explains how to make a power statistics CCDF measurement on a cdma2000 mobile station. Power Complementary Cumulative Distribution Function (CCDF) curves characterize the higher level power statistics of a digitally modulated signal.

### Configuring the Measurement System

The mobile station (MS) under test has to be set to transmit the RF power remotely through the system controller. This transmitting signal is connected to the instruments RF input port. Connect the equipment as shown.

**Figure 2-11** Power Statistics (CCDF) Measurement System

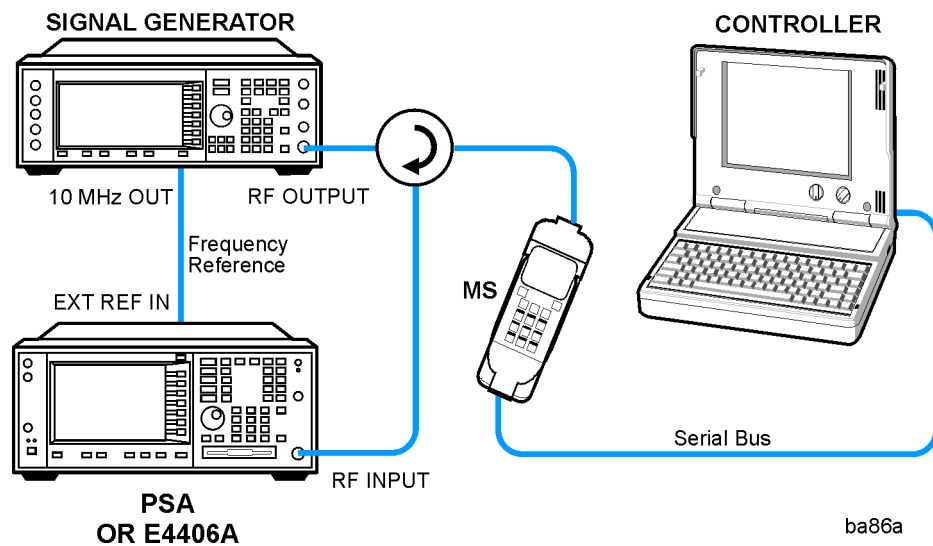

1. Using the appropriate cables, adapters, and circulator, connect the output signal of the MS to the RF input of the instrument.
2. Connect the base transmission station simulator or signal generator to the MS through a circulator to initiate a link constructed with sync and pilot channels, if required.
3. Connect a BNC cable between the 10 MHz OUT port of the signal generator and the EXT REF IN port of the instrument.
4. Connect the system controller to the MS through the serial bus cable to control the MS operation.

### Setting the MS

From the base transmission station simulator and the system controller, set up a call using Rate Set 1 Fundamental Code Channel

loopback mode (Service Option 2) with 9600 bps data rate only required for the MS to transmit the RF power as follows:

- MS: Band Class 1, Block Designator A, Class III
- Frequency: 1855.000 MHz (preferred set channel number 100)  
 (=  $100 \times 0.050 + 1850.000$  MHz)
- Output Power: -3 dBW (0.5 W) controlled by '0' power control bits

## Measurement Procedure

- Step 1.** Press the **Preset** key to preset the instrument.
- Step 2.** Press the **MODE, More (1 of 2), cdma2000** keys to enable the cdma2000 measurements.
- Step 3.** Press the **Mode Setup, Radio, Device** to toggle the device to **MS**.
- Step 4.** Press the **FREQUENCY Channel, 1855, MHz** keys to set the center frequency to 1,855.000 MHz.
- Step 5.** Press the **MEASURE, More (1 of 2), Power Stat CCDF** keys to initiate the power statistics CCDF measurement.

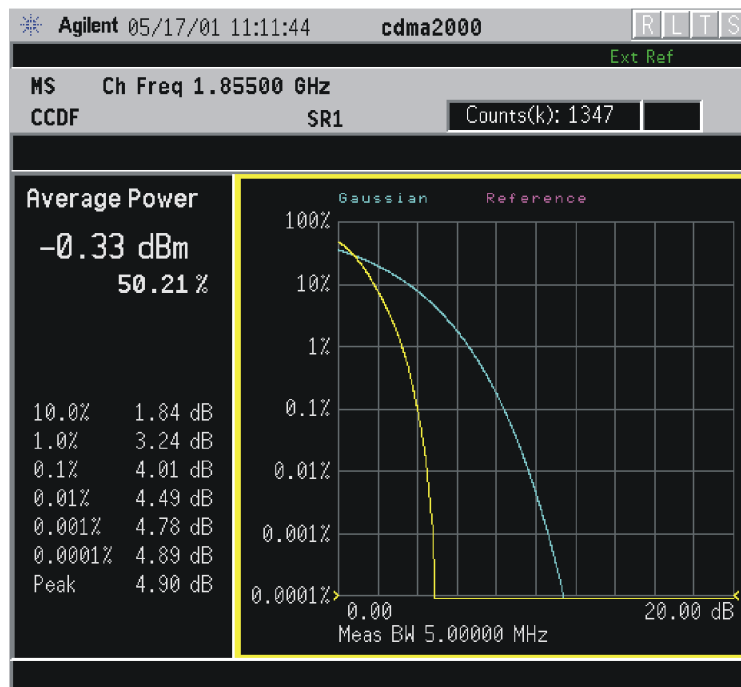

The CCDF measurement result should look like the above figure. The measurement result values are shown in the summary result window.

- Step 6.** To make a measurement repeatedly, press **Meas Control, Measure** to toggle the setting from **Single** to **Cont**.
- Step 7.** Press the **Meas Setup, More (1 of 2)** keys to check the keys available to change the measurement parameters from the default condition.

If you have a problem, and get an error message, see [“If You Have a Problem”](#) on page 70.

---

## If You Have a Problem

During the execution of your measurement you may encounter problems which generate error codes. Reference to the following common errors may be helpful.

If **Err** is shown in the annunciator bar, press the **System, Show Errors** hard and soft keys to read the detailed error information.

- **Measurement Instability- Low Input Signal Level**

If the input signal level is too low to make a valid measurement no code domain power will be displayed in the **Power** graph window. In this situation, no error message can be displayed to indicate the nature of the fault. If you cannot increase the power into the tester, you need to increase the input sensitivity by adjusting the **ADC** range.

Press **Meas Setup, More (1 of 3), More (2 of 3), Advanced, ADC Range,** and then **Manual** keys. Increase the setting from the  $-6$  dB (for E4406A) or None (for PSA) default to 6 dB, for example. Another option is to use the **Auto** setting (the **Auto** setting is not used as the default to improve measurement speed).

Press **Restart** to make another measurement and observe the results. Re-adjust the **ADC** as necessary to obtain a valid measurement.

- **Error Code 16 “Input overload”**

This error means that your measurement has erroneous results due to the excessive input power level. To correct this condition, the input signal level must be reduced by using the internal and/or external attenuators.

Press the **Mode Setup, Input, Input Atten** keys to enter an attenuation value to reduce the transmitted power from the MS. This allowable range is up to 40 dB.

If you want to attenuate more than 40 dB, connect your external attenuator between the **RF INPUT** port and the DUT. Be sure to add its attenuation value to the readings of the measurement result.

To automate this calculation, press the **Mode Setup, Input, Ext Atten** keys to enter the additional attenuation value. The allowable range is up to 100 dB. The power readings of the measurement will take into account the external attenuation value.

- **Error Code 601 “Signal too noisy”**

This error means that your input signal is too noisy to capture the correct I/Q components. To make a more stable measurement the trigger source may need to be set to **Frame**, for example.

- **Error Code 604 “Can not correlate to input signal”**

This error means that the tester has failed to find any active channels in the input signal as specified. To improve the correlation some critical parameter needs to be adjusted, like the input signal level or scramble code, for example.

For more details consult the chapter in this book dedicated to the measurement in question, or “Instrument Messages and Functional Tests”, publication number E4440-90047.

Getting Started  
If You Have a Problem



---

## **3**      **Setting Up the Mode**

---

## cdma2000 Mode

Instructions for installing and uninstalling personality options are under [“Installing Optional Measurement Personalities” on page 114](#).

To access the cdma2000 measurement personality, press the **MODE** key and select the **cdma2000** key.

For E4406A Option B7C, be sure to refer to the descriptions and default values for [“Using Option B7C Baseband I/Q Inputs” on page 238](#).

If you want to set the cdma2000 mode to a known, factory default state, press **Preset**. This will preset the mode setup and all of the measurements to the factory default parameters.

---

### NOTE

For PSA, note that pressing the **Preset** key does not switch instrument modes if the Mode type of preset is selected under **System, Power On/Preset**.

---

## Making a Measurement

This instrument enables you to make a wide variety of measurements on digital communications equipment using the **Basic Mode** (for E4406A), or the **Spectrum Analysis Mode** (for PSA) measurement capabilities. It also has optional measurement personalities that make measurements based on established industry standards.

To set up the instrument to make measurements, you need to:

1. Press **MODE** to select a personality which corresponds to a digital communications format, like cdma2000, W-CDMA, or EDGE. Or use the **Basic mode** to make measurements on signals with non-standard formats. After selecting the mode, make any required adjustments to the mode settings by pressing **Mode Setup**.
2. Press **MEASURE** to select a specific measurement to be performed, like ACP, Channel Power, or EVM, and so forth. After selection of your measurement, make any required adjustments to the measurement settings by pressing **Meas Setup**.

Depending on the current settings of **Meas Control**, the instrument will begin making the selected measurements. The resulting data will be shown on the display or available for export.

3. Press **Trace/View** to display the data from the current measurement. Depending on the mode and measurement selected, various graphical and tabular presentations are available.

The main keys used in the three steps are shown in the table below.

Step	Primary Key	Setup Keys	Related Keys
1. Select & setup a mode	<b>MODE</b>	<b>Mode Setup, Input (E4406A), Input/Output (PSA), FREQUENCY Channel</b>	<b>System</b>
2. Select & setup a measurement	<b>MEASURE</b>	<b>Meas Setup</b>	<b>Meas Control, Restart</b>
3. Select & setup a view	<b>View/Trace (E4406A), Trace/View (PSA)</b>	<b>SPAN X Scale, AMPLITUDE Y Scale, Display, Next Window, Zoom</b>	<b>File, Save, Print, Print Setup, Marker, Search (E4406A), Peak Search (PSA)</b>

A setting may be reset at any time, and will be in effect on the next measurement cycle or View.

## Changing the Mode Setup

Numerous settings can be changed at the mode level by pressing the **Mode Setup** key. This will access the menu with the selections listed below. The factory default settings are shown in tables. These settings affect only the measurements in the cdma2000 mode.

## Configuring the Radio Setting

The **Radio** key accesses the menu as follows:

- **Device** - Allows you to toggle the test device between **BTS** (Base Transmission Station) and **MS** (Mobile Station).

Radio Default Setting	
Device	BTS

## Configuring the Input Condition

The **Input** key accesses the menu as follows: (You can also access this menu from the **Input/Output** front-panel key.)

- **Input Port** - Allows you to access the menu to select one of the signal input ports as follows (including Baseband IQ Inputs for E4406A Option B7C, when installed):
  - **RF** - Allows you to measure an RF signal supplied to the front panel RF input port.
  - **I/Q** - (For E4406A Option B7C) Allows you to measure the I/Q input signals supplied to the front panel **I** and **Q INPUT** ports.
  - **I only** - (Basic mode for E4406A Option B7C) Allows you to

## Setting Up the Mode

### cdma2000 Mode

- measure the I input signal supplied to the front panel **I INPUT** port.
- **Q only** - (Basic mode for E4406A Option B7C) Allows you to measure the Q input signal supplied to the front panel **Q INPUT** port.
  - **50 MHz Ref** - (For E4406A) Allows you to measure the **50 MHz Reference** signal to calibrate the instrument.
  - **Amptd Ref (f=50 MHz)** - (For PSA) Allows you to measure the 50 MHz reference signal to calibrate the instrument.
  - **IF Align** - Allows you to configure the IF alignment signal. The RF path is switched to bring in the same alignment signal that is automatically switched to perform many alignments.
  - **Baseband Align Signal** - (For E4406A Option B7C) Selects an internal signal used for alignment of the baseband I/Q inputs.
  - **I/Q Setup** - (For E4406A Option B7C) Allows you to access the menu to select the input impedance for the baseband I/Q input signals, and to set the dc offset voltages for I/Q input signals. This key is grayed out unless **Input Port** is set to **I/Q**.
    - **I Offset** - Allows you to set a dc offset voltage value for the I input signal. The range is 0.0000 to 2.5600 V in 0.0001 V.
    - **Q Offset** - Allows you to set a dc offset voltage value for the Q input signal. The range is 0.0000 to 2.5600 V in 0.0001 V.
    - **I/Q Input Z** - Allows you to access the menu to select one of the input impedances for baseband I/Q input signals as follows:
      - 50  $\Omega$  Unbalanced** - Allows you to set the input impedance to unbalanced 50  $\Omega$  for use with the I/Q input ports. This is the default setting.
      - 600  $\Omega$  Balanced** - Allows you to set the input impedance to balanced 600  $\Omega$  for use with the I/Q input ports and the  $\bar{I}/\bar{Q}$  input ports.
      - 1 M $\Omega$  Unbalanced** - Allows you to set the input impedance to unbalanced 1 M $\Omega$  for use with the I/Q input ports.
      - 1 M $\Omega$  Balanced** - Allows you to set the input impedance to balanced 1 M $\Omega$  for use with the I/Q input ports and the  $\bar{I}/\bar{Q}$  input ports.
    - **I/Q Z Ref for Input Z = 1 M $\Omega$**  - Allows you to enter a numeric value to set the reference impedance if **I/Q Input Z** is set to 1 M $\Omega$ , otherwise this key is grayed out. The range is 1.0  $\Omega$  to 10.0 M $\Omega$  in steps 1  $\Omega$ . The default value is 50.0  $\Omega$ .
  - **RF Input Range** - Allows you to toggle the RF input range control between **Auto** and **Man** (manual). If **Auto** is chosen, the instrument

automatically sets the attenuator based on the carrier power level, where it is tuned. Once you change the **Max Total Pwr** or **RF Input Atten** value with the RPG knob, for example, the **RF Input Range** key is automatically set to **Man**. If there are multiple carriers present, the total power might overdrive the front end. In this case you need to set the **RF Input Range** to **Man** and enter the expected maximum total power by activating the **Max Total Pwr** key. **Man** is also useful to hold the input attenuation constant for the best relative power accuracy. For single carriers it is generally recommended to set this to **Auto**.

For PSA, when you use the internal preamplifier, **Int Preamp**, the selections using the **RF Input Range** key are not available, and the key is grayed out.

For E4406A Option B7C, if **Input Port** is set to **I/Q**, this key is grayed out

- **I/Q Range** - (For E44046A Option B7C) Allows you to select a value for the maximum voltage range of the baseband I/Q input signals, when **Input Port** is set to **I/Q**, otherwise this key is not available. The choices are 125.0 mV, 250.0 mV, 500.0 mV, and 1.00 V.
- **Max Total Pwr** - Allows you to set the maximum total power level from the UUT (Unit Under Test). The range is -200.00 to 100.00 dBm with 0.01 dB resolution. This is the expected maximum value of the mean carrier power referenced to the output of the UUT; it may include multiple carriers. The **Max Total Pwr** setting is coupled together with the **Input Atten** and **Ext Atten** settings. Once you change the **Max Total Pwr** value with the RPG knob, for example, the **Input Range** key is automatically set to **Man**.

For PSA, when you use the internal preamplifier, **Int Preamp**, the selections using the **Max Total Pwr** key are not available, and the key is grayed out.

For E4406A Option B7C, when **Input Port** is set to **I/Q**, this key label changes to **I/Q Range**.

- **Input Atten** - Allows you to control the internal input attenuator setting. The range is 0 to 40 dB with 1 dB resolution. The **Input Atten** key reads out the actual hardware value that is used for the current measurement. If more than one input attenuator value is used in a single measurement, the value used at the carrier frequency will be displayed. The **Input Atten** setting is coupled to the **Max Total Pwr** setting. Once you change the **Input Atten** setting with the RPG knob, for example, the **Input Range** key is automatically set to **Man**.

For PSA, when you use the internal preamplifier, **Int Preamp**, the electronic attenuator selections using the **Input Atten** key are not available, and the key is grayed out. Use the mechanical attenuator under **More 1 of 2, Attenuator**, below.

For E4406A Option B7C, if **Input Port** is set to **I/Q**, this key is not

## Setting Up the Mode

### cdma2000 Mode

available as this attenuator is located in front of the first down converter, therefore it cannot be used for the baseband I/Q input signals.

- **Ext RF Atten** - Allows you to access the following menu to enter the external attenuation values. Either of the **Ext RF Atten** settings is coupled together with the **RF Input Range** setting. However, pressing **Ext RF Atten** does not switch the **RF Input Range** key to **Man**. This will allow the instrument to display the measurement results referenced to the output of the UUT.
  - **MS** - Allows you to set an external attenuation value for MS tests. The range is  $-50.00$  to  $+50.00$  dB with 0.01 dB resolution.
  - **BTS** - Allows you to set an external attenuation value for BTS tests. The range is  $-50.00$  to  $+50.00$  dB with 0.01 dB resolution.
- **Int Preamp** - (For PSA Option 1DS) Allows you to control the internal RF input preamplifier. The internal preamplifier provides +30 dB of gain and is useful for lower power measurements. The **Int Preamp** setting default is **Off**. RF power values displayed for these measurements are adjusted to compensate for the internal preamplifier gain, and indicate power levels at the input port. The preamplifier is only available for Modulation Accuracy (EVM and Peak Code Domain Error) measurements, QPSK EVM, and Code Domain measurements. If the **Int Preamp** is not available for a particular measurement, the key is grayed out.

To avoid damaging the internal preamplifier, limit the total power applied to the RF input to  $\leq +25$  dBm.

When using the internal preamplifier, the electronic attenuator selections using the **Input Atten** key are not available, and the key is grayed out. Use the mechanical attenuator under **More, Attenuator**, below.

- **Attenuator** - (For PSA Option 1DS) When **Int Preamp** is set to **On**, this key allows you to control an internal mechanical input attenuator setting. The choices are 0 dB, 10 dB, and 20 dB. The **Attenuator** key shows the actual hardware value that is used for the current measurement. The **Attenuator** setting is not coupled to the **Max Total Pwr** setting.

The **Attenuator** is only available for measurements which can use the **Int Preamp**: Modulation Accuracy (EVM and Peak Code Domain Error) measurements, QPSK EVM, and Code Domain measurements. If the **Int Preamp** is not available for a particular measurement, the key is grayed out.

---

**NOTE**

The **Max Total Pwr** and **Input Atten** settings are coupled together, so changing the input **Max Total Pwr** setting by x dB changes the **Input Atten** setting by x dB. When you switch to a different measurement, the **Max Total Pwr** setting is kept constant, but the **Input Atten** may change if the two measurements have different mixer margins. Therefore, you can set the input attenuator manually, or you can set it indirectly by specifying the expected maximum power from the UUT.

---

- **IF Align Signal** - Allows you to access the following menu to select one of the signals to be used for IF alignment.
  - **Signal Rate** - Allows you to set a value to be used for dividing the fundamental frequency of 468.75 kHz. The value ranges from 0 to 12 as the power of 2.
  - **Signal Amptd** - Allows you to set an amplitude value to be applied to the digital analog converter, for the IF alignment signal. The value ranges from 0 to 4095.
  - **Signal Type** - Allows you to access the following menu to select one of the signal types.
    - CW** - Sets the IF alignment signal to CW.
    - Comb** - Sets the IF alignment signal to comb wave.
    - Pulse** - Sets the IF alignment signal to pulse wave.

The following table lists the factory default setting for Input.

Input Default Settings	
Input Port	RF
RF Input Range <sup>a</sup>	Auto <sup>b</sup>
I/Q Setup <sup>c</sup> (E4406A Option B7C)	(disabled)
I/Q Range <sup>c</sup> (E4406A Option B7C)	1.00 V (disabled)
Max Total Pwr <sup>a</sup>	-15.00 dBm <sup>d</sup>
Input Atten <sup>a</sup>	0.00 dB <sup>d</sup>
Ext RF Atten: MS BTS	0.00 dB 0.00 dB
Int Preamp <sup>e</sup> (PSA)	OFF
Attenuator <sup>e</sup> (PSA)	0 dB
IF Align Signal: Signal Rate Signal Amptd Signal Type	0; = 468.75 kHz DAC 500 CW

- a. This key is grayed out or not available if **Input Port** is set to **I/Q**.
- b. Auto is not used for Spectrum (frequency domain) measurements.
- c. This key is not available if **Input Port** is set to **RF**.
- d. This may differ if the maximum input power is more than -15.00 dBm, or depending on the previous measurements.
- e. The internal preamplifier and attenuator are available for Modulation Accuracy (EVM and Peak Code Domain Error) measurements, QPSK EVM, and Code Domain measurements on PSA with Option 1DS.



## Configuring the Trigger

The **Trigger** key allows you:

- (1) to access the trigger selection menu to specify each triggering condition,
- (2) to modify the default trigger holdoff time using the **Trig Holdoff** key,
- (3) to modify the auto trigger time and to activate or deactivate the auto trigger feature using the **Auto Trig** key, and
- (4) to modify the period of the frame timer using the **Frame Timer** key.

---

**NOTE**

The actual trigger source is selected individually for each measurement under the **Meas Setup** key.

- **RF Burst, Video (Envlp), Ext Front, Ext Rear**- Pressing one of these trigger keys will access each triggering condition setup menu. This menu is used to specify the **Delay**, **Level** and **Slope** settings for each trigger source as follows:
  - **Delay** - Allows you to enter a numerical value to modify the trigger delay time. The range is  $-100.0$  to  $+500.0$  ms with  $1\ \mu\text{s}$  resolution. For trigger delay use a positive value, and for pre-trigger use a negative value.
  - **Level** - Allows you to enter a numerical value to adjust the trigger level depending on the trigger source selected.
    - For **RF Burst**, the key label reads as **Peak Level**. The RF level range is  $-25.00$  to  $0.00$  dB with  $0.01$  dB resolution, relative to the peak RF signal level. The realistic range can be down to  $-20$  dB.
    - For **Video (Envlp)**, the video level range is  $-200.00$  to  $+50.00$  dBm with  $0.01$  dB resolution at the RF input. The realistic range can be down to around  $-50$  dBm depending on the noise floor level of the input signal.
    - For **Ext Front** or **Ext Rear**, the level range is  $-5.00$  to  $+5.00$  V with  $1$  or  $10$  mV resolution.
  - **Slope** - Allows you to toggle the trigger slope between **Pos** at the positive-going edge and **Neg** at the negative-going edge of the burst signal.

There are other keys under the **Trigger** key as follows:

- **Trig Holdoff** - Allows you to set the period of time before the next trigger can occur. The range is  $0.000\ \mu\text{s}$  to  $500.0$  ms with  $1\ \mu\text{s}$  resolution.
- **Auto Trig** - Allows you to specify a time for a trigger timeout and

## Setting Up the Mode

### cdma2000 Mode

toggle the auto trigger function between **On** and **Off**. The range is 1.000 ms to 1.000 ks with 1  $\mu$ s resolution. If no trigger occurs by the specified time, a trigger is automatically generated.

- **Frame Timer** - Allows you to access the menu to manually control the frame timer:
  - **Period** - Allows you to set the period of the frame clock. The range is 0.000 ns to 559.0000 ms with 1 ps resolution.
  - **Offset** - Allows you to set the offset of the frame clock. The range is 0.000 to 10.00 s with 100 ns resolution over 1.000  $\mu$ s range.
  - **Reset Offset Display** - Allows you to display without any offset of the frame clock.
  - **Sync Source** - Allows you to access the menu to select one of the sources to be synchronized with.
    - Off** - Allows you to turn the synchronizing source off for asynchronous tests.
    - RF Burst (Wideband)** - Allows you to select the RF burst signal as the synchronizing source.
    - Ext Front** - Allows you to select the external input signal from the front-panel input port as the synchronizing source.
    - Ext Rear** - Allows you to select the external input signal from the rear panel input port as the synchronizing source.

The trigger default settings are listed in the following table:

<b>Trigger Default Settings</b>	
RF Burst: Delay Peak Level Slope	0.000 $\mu$ s -6.00 dB Pos
Video (Envlp): Delay Level Slope	0.000 $\mu$ s -6.00 dBm Pos
Ext Front: Delay Level Slope	0.000 $\mu$ s 2.00 V Pos
Ext Rear: Delay Level Slope	0.000 $\mu$ s 2.00 V Pos
Trig Holdoff	0.000 ms

Trigger Default Settings	
Auto Trig	100.0 ms; Off
Frame Timer:	
Period	26.666667 ms
Offset	0.000 ms
Sync Source	Off

### Configuring the Demodulation

The **Demod** key allows you to make measurements on base stations with either the single carrier signal or the multiple carrier signal. This is effective for the code domain, modulation accuracy, and QPSK EVM measurements.

- **RF Carrier** - Allows you to toggle the RF structure between **Single** and **Multi**. If set to **Single**, a 3.75 MHz wide carrier is used with 625 kHz guard bands on both sides as an air interface option. If set to **Multi**, three adjacent 1.25 MHz wide carriers are used with 625 kHz guard bands on both sides of each carrier, where overlay operation with TIA/EIA-95-B is allowed.

Demodulation Default Setting	
Demod: RF Carrier	Single

### Changing the Frequency Channel

After selecting the desired mode setup, you will need to select the desired center frequency and the center frequency step. The selections made here will apply to all measurements in the mode. Press the **FREQUENCY Channel** key to access the following menu:

- **Center Freq** - Allows you to enter a frequency that corresponds to the desired RF channel to be measured. This is the current instrument center frequency. The range is 1.000 kHz to 4.32140 GHz with 1 Hz resolution for E4406A, however, PSA Series have different ranges.
- **CF Step** - Allows you to enter a center frequency step to shift the measurement segment, and to toggle the step function between **Auto** and **Man**. If set to **Auto**, the **CF Step** value automatically changes according to the selection of the standard. The range is 1.000 kHz to 1.00000 GHz with 1 Hz resolution.

Frequency Channel Default Settings	
FREQUENCY Channel:	
Center Freq	1.00000 GHz
CF Step	1.25000 MHz, Auto

---

**NOTE**

For E4406A Option B7C, if **Input Port** is set to **I/Q**, the **Center Freq** and **CF Step** keys are disabled as the baseband I/Q signal frequencies are centered at 0 Hz.

---

## cdma2000 Measurement Key Flow

The key flow diagrams, shown in a hierarchical manner on the following pages, will help you grasp the overall functional relationships for the front-panel keys and the keys displayed at the extreme right side of the screen. The diagrams are:

- “MODE Selection Key Flow” on page 86
- “Mode Setup/FREQUENCY Channel Key Flow (1 of 2)” on page 87
- “Measurement Selection Key Flow” on page 89
- “Channel Power Measurement Key Flow” on page 89
- “ACPR Measurement Key Flow” on page 90
- “Intermodulation Measurement Key Flow” on page 91
- “Spectrum Emission Mask Measurement Key Flow (1 of 2)” on page 92
- “Occupied Bandwidth Measurement Key Flow” on page 94
- “Code Domain Measurement Key Flow (1 of 5)” on page 95
- “Modulation Accuracy Measurement Key Flow (1 of 3)” on page 100
- “QPSK EVM Measurement Key Flow (1 of 2)” on page 103
- “Power Statistics CCDF Measurement Key Flow” on page 105
- “Spectrum (Freq Domain) Measurement Key Flow (1 of 4)” on page 106
- “Waveform (Time Domain) Measurement Key Flow (1 of 3)” on page 110

Use these flow diagrams as follows:

- There are some basic conventions:

Meas Setup

An oval represents one of the front-panel keys.

EDGE EVM

This box represents one of the keys displayed.

<for EVM>

This represents an explanatory description on its specific key.

Avg Bursts 20 OnOff

This box shows how the key default condition is displayed. Default parameters or values are underlined wherever possible.

- Start from the upper left corner of each measurement diagram. Go to the right, and go from the top to the bottom.
- When changing a key from auto (with underline) to manual, just press that key one time.
- When entering a numeric value of **FREQUENCY Channel**, for example,

## Setting Up the Mode

### cdma2000 Measurement Key Flow

use the numeric keypad and terminate the entry with the appropriate unit selection from the softkeys displayed.

- When entering a numeric value for a unit-less value, like **Avg Number**, use the numeric keypad and terminate the entry with the **Enter** front-panel key.
- Instead of using the numeric keypad to enter a value, it may be easier to use the RPG knob or **Up/Down** keys.

**Figure 3-1**

### MODE Selection Key Flow

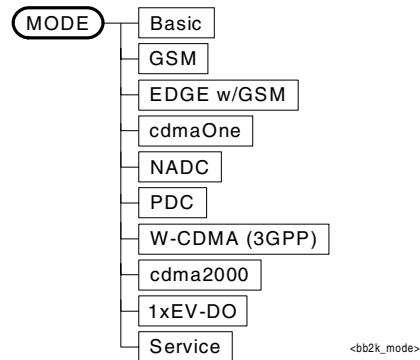

Figure 3-2

Mode Setup/FREQUENCY Channel Key Flow (1 of 2)

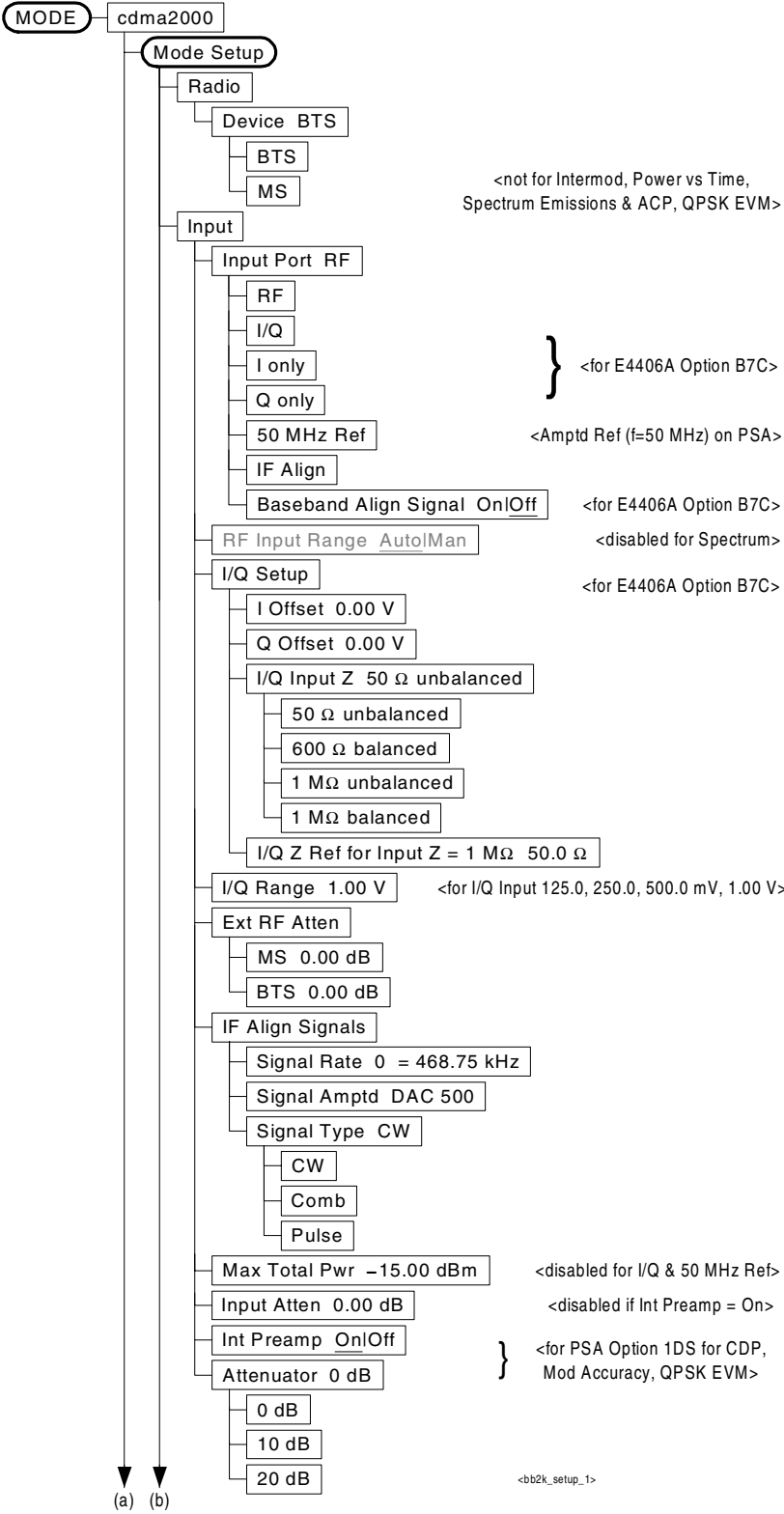
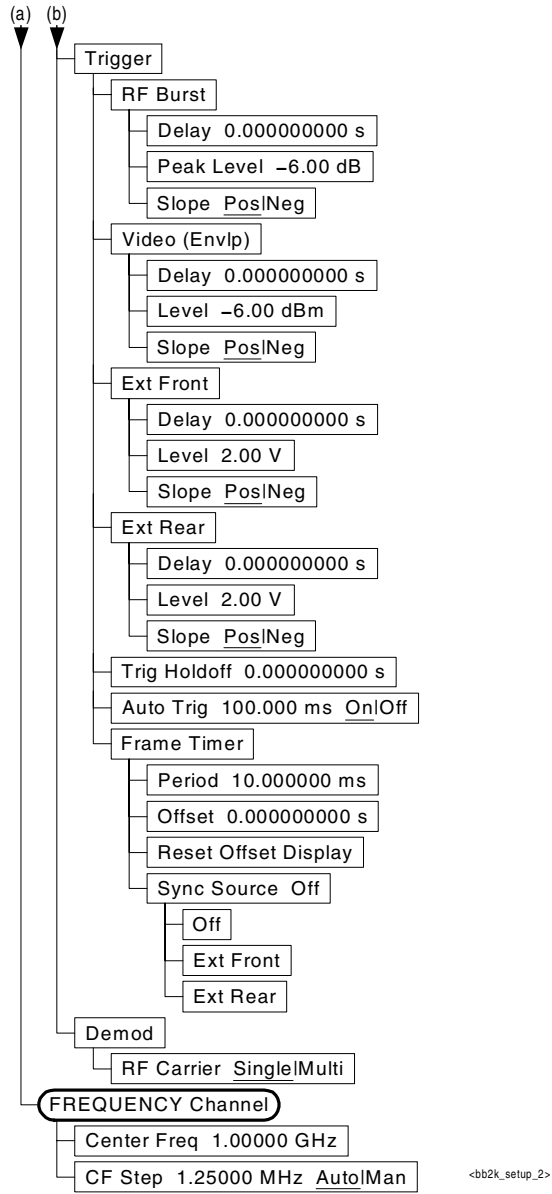
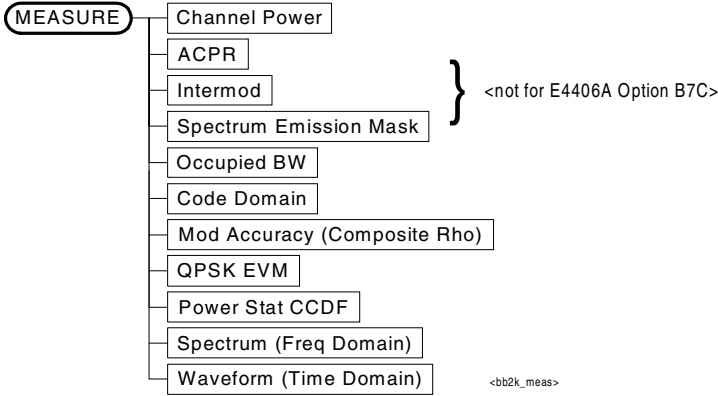

Figure 3-3 Mode Setup/FREQUENCY Channel Key Flow (2 of 2)

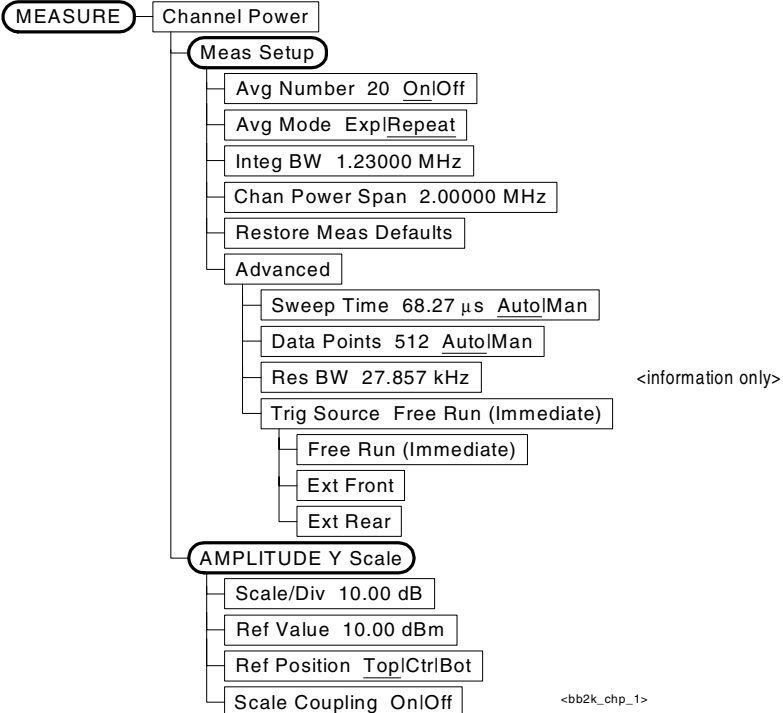



**Figure 3-4 Measurement Selection Key Flow**



**Figure 3-5 Channel Power Measurement Key Flow**



**Figure 3-6 ACPR Measurement Key Flow**

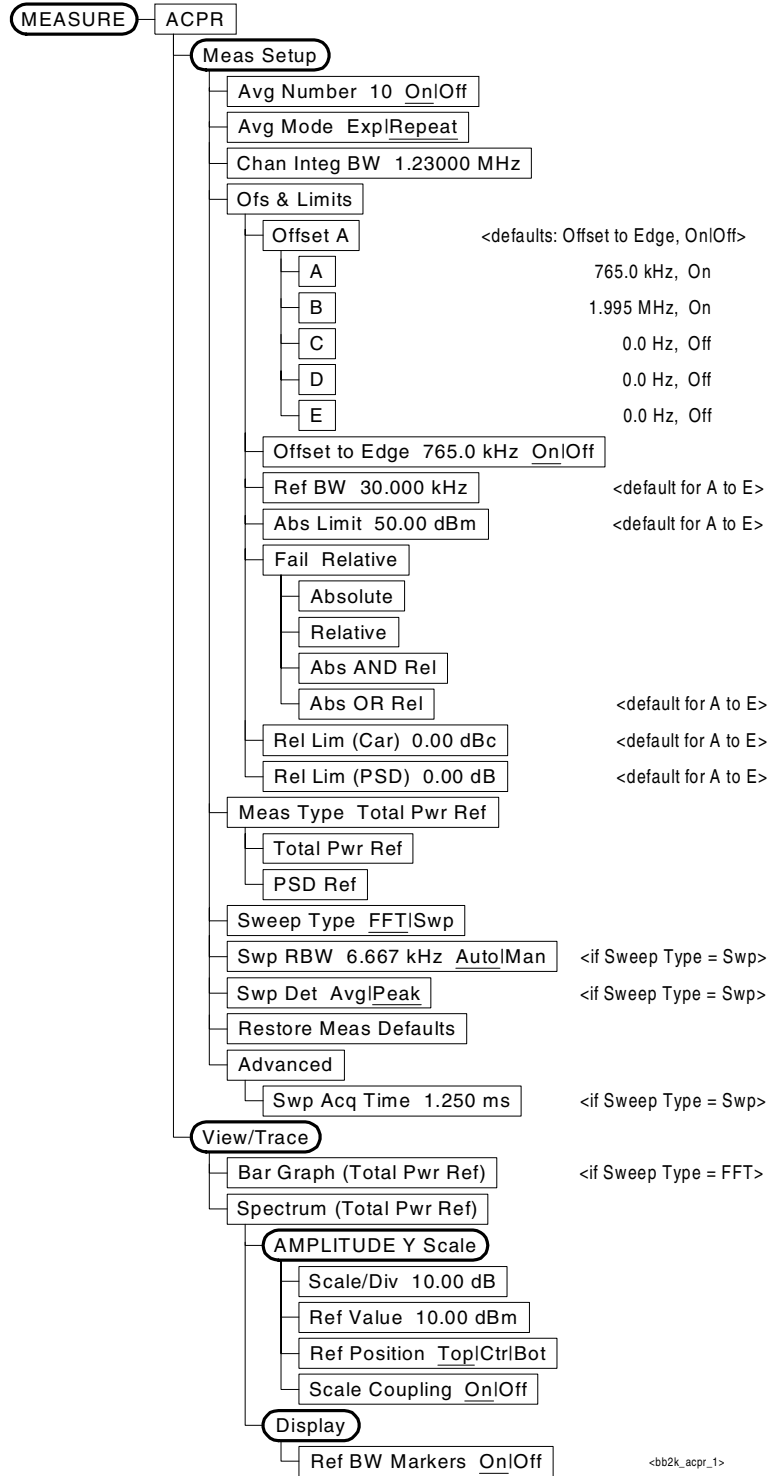
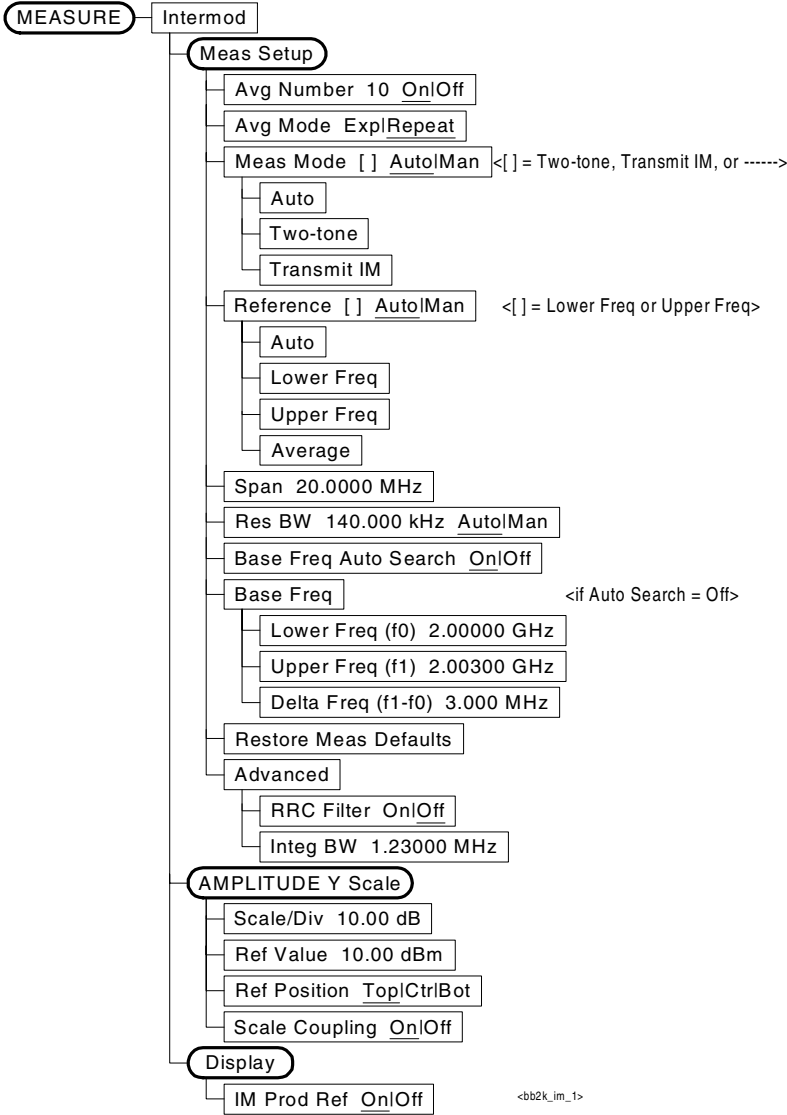

Figure 3-7 Intermodulation Measurement Key Flow



**Figure 3-8 Spectrum Emission Mask Measurement Key Flow (1 of 2)**

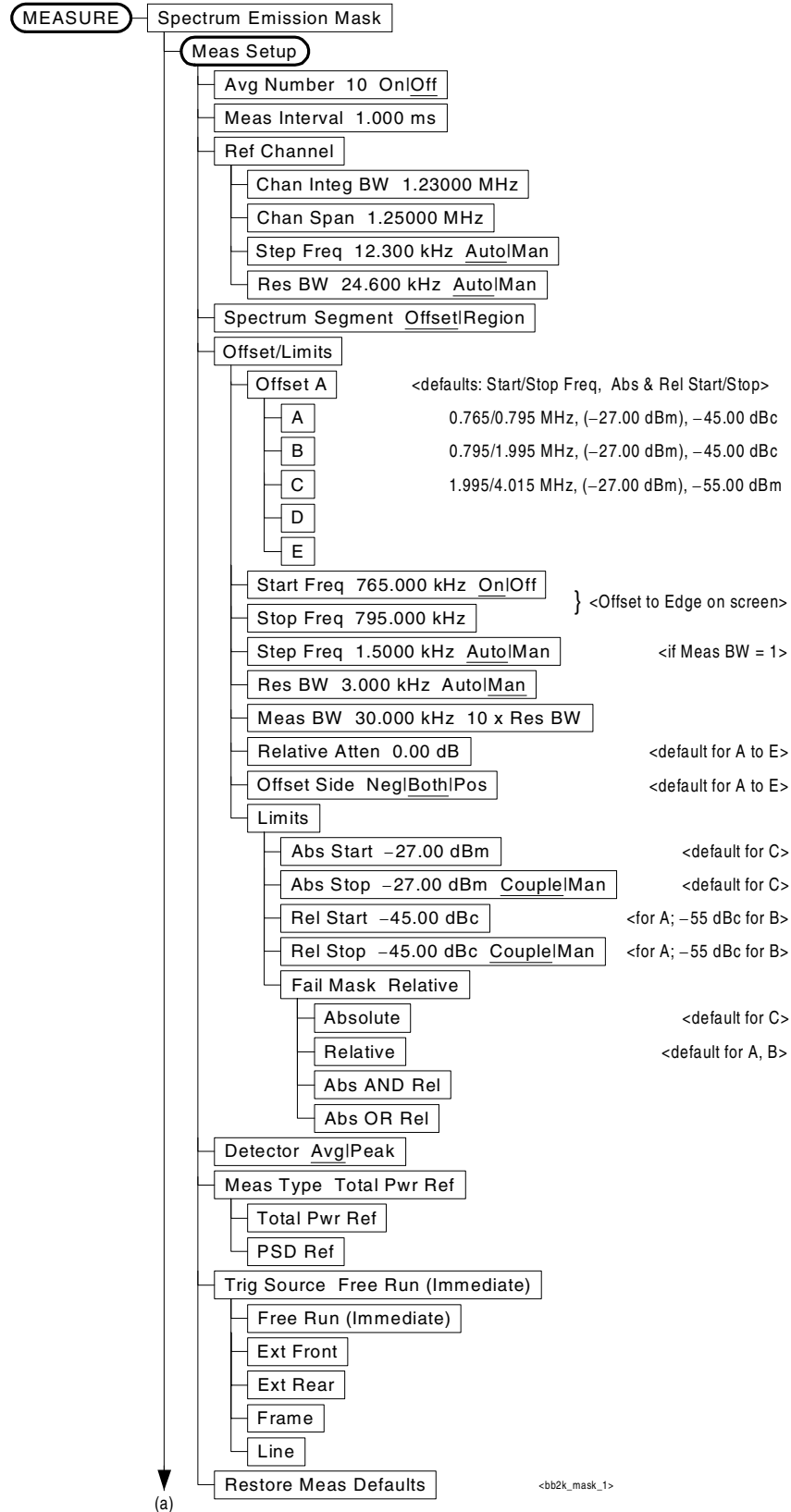
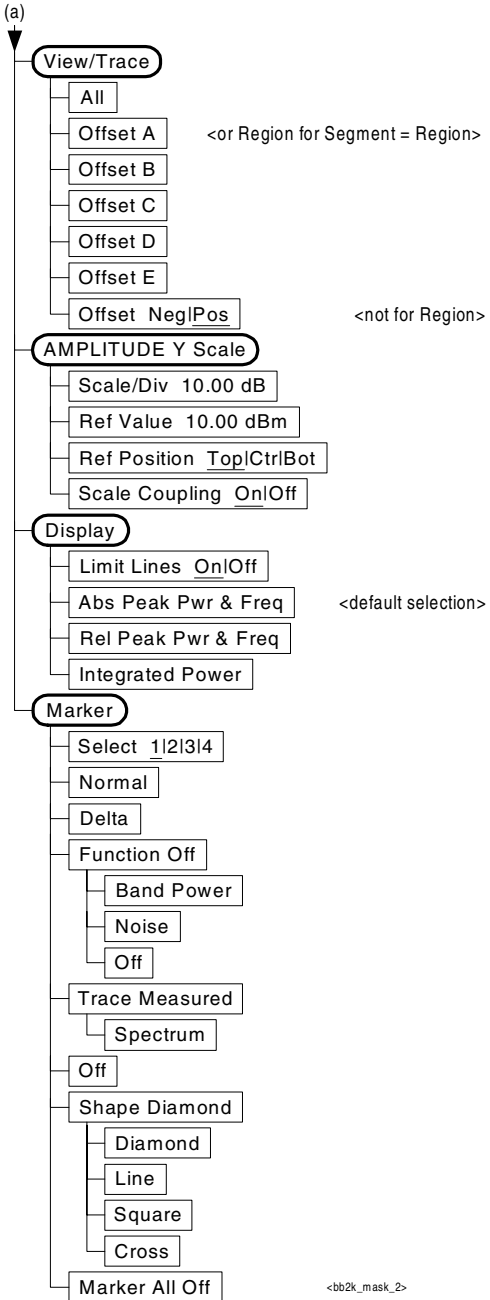

Figure 3-9 Spectrum Emission Mask Measurement Key Flow (2 of 2)



**Figure 3-10 Occupied Bandwidth Measurement Key Flow**

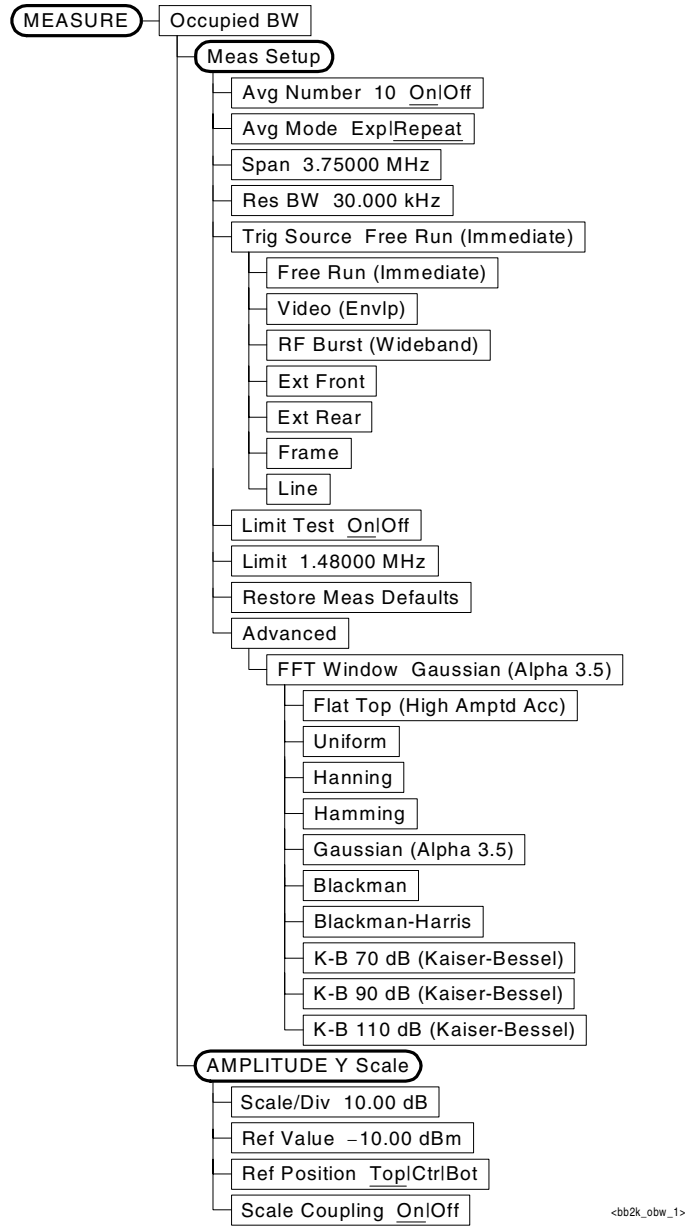
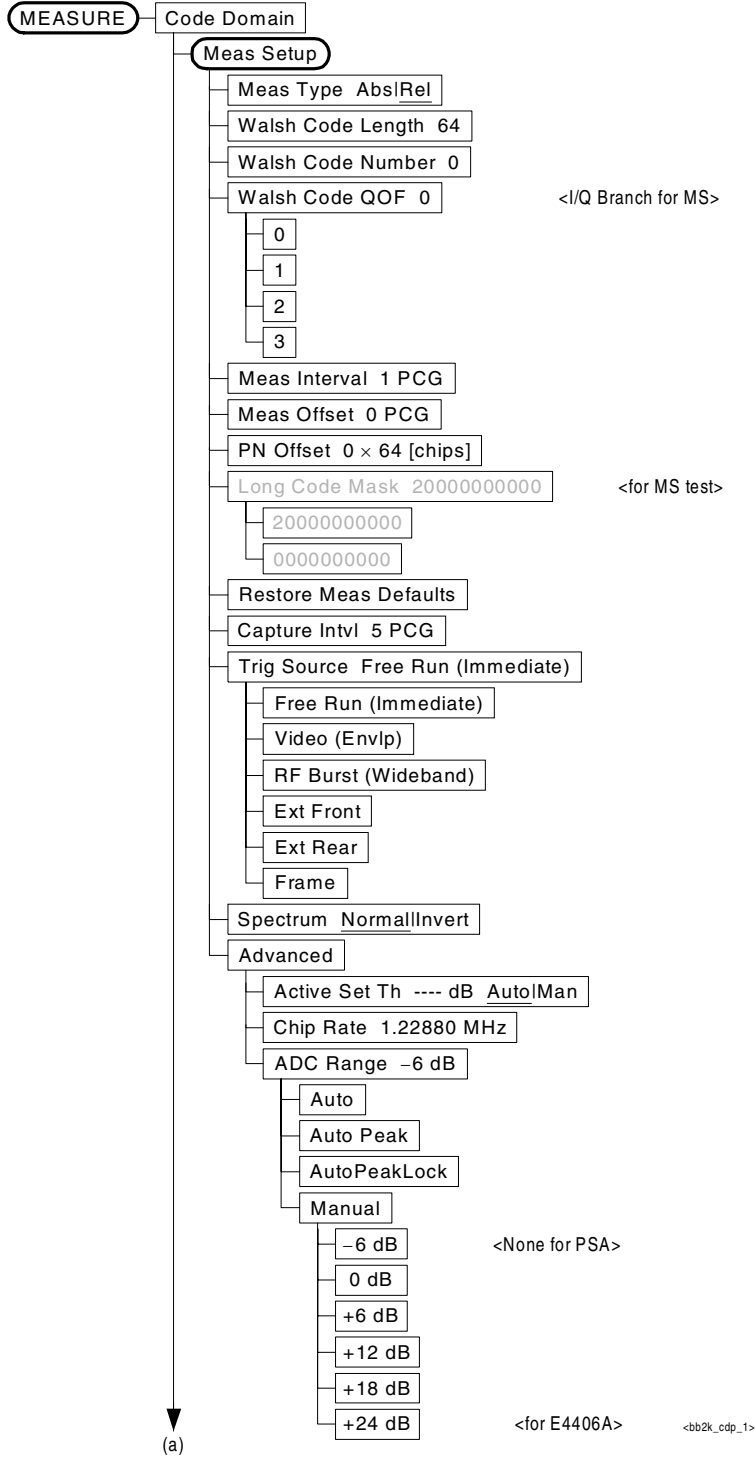

Figure 3-11 Code Domain Measurement Key Flow (1 of 5)



**Figure 3-12 Code Domain Measurement Key Flow (2 of 5)**

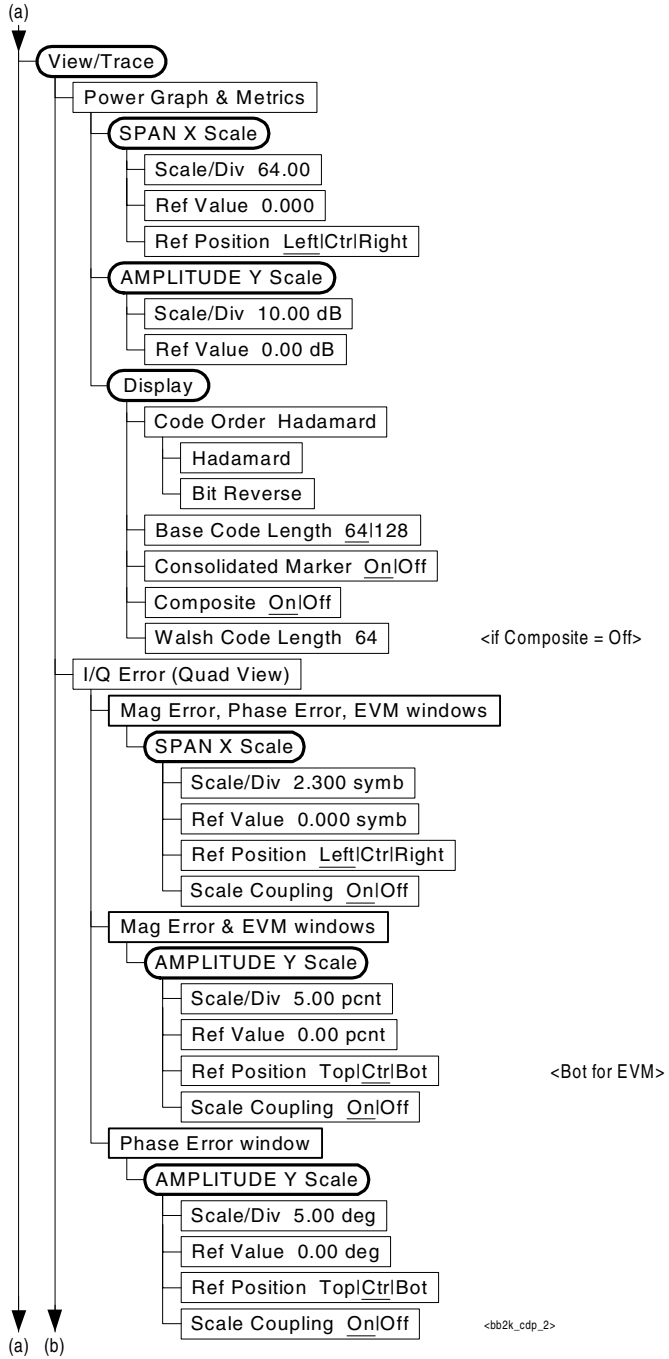
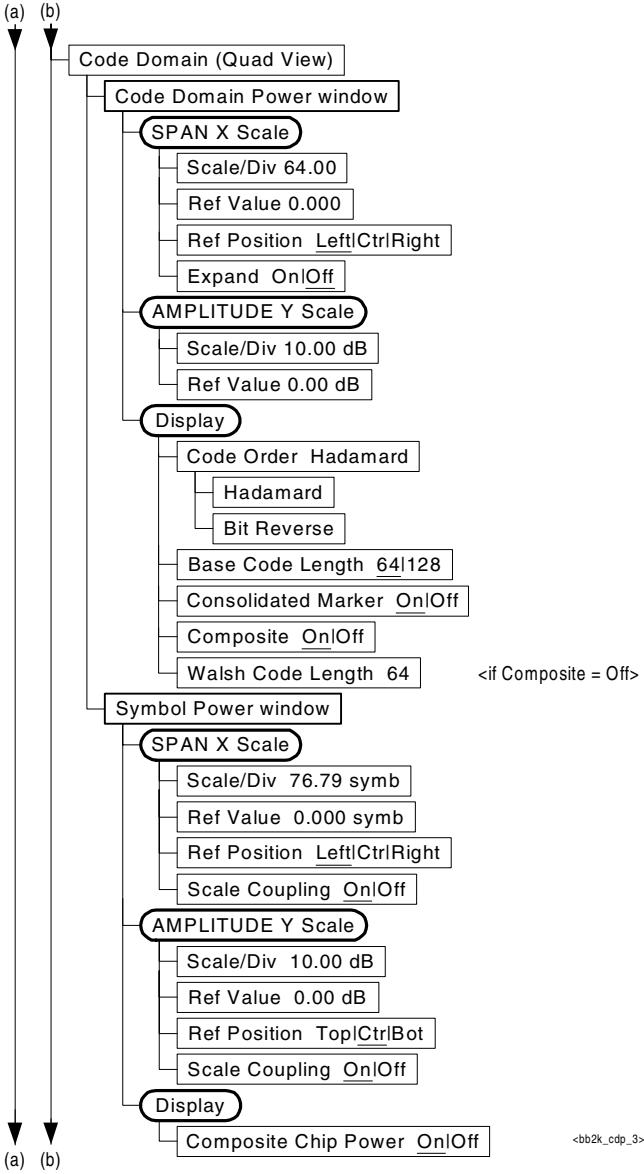



Figure 3-13 Code Domain Measurement Key Flow (3 of 5)



**Figure 3-14 Code Domain Measurement Key Flow (4 of 5)**

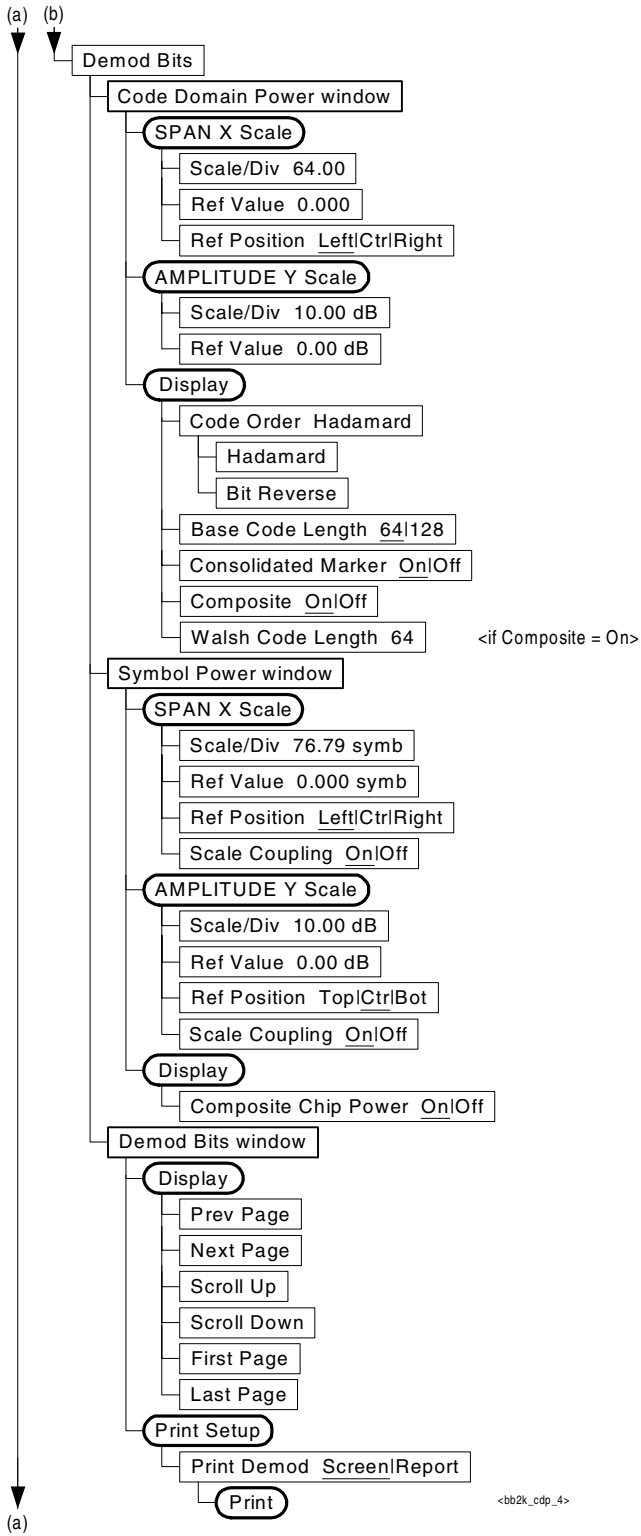
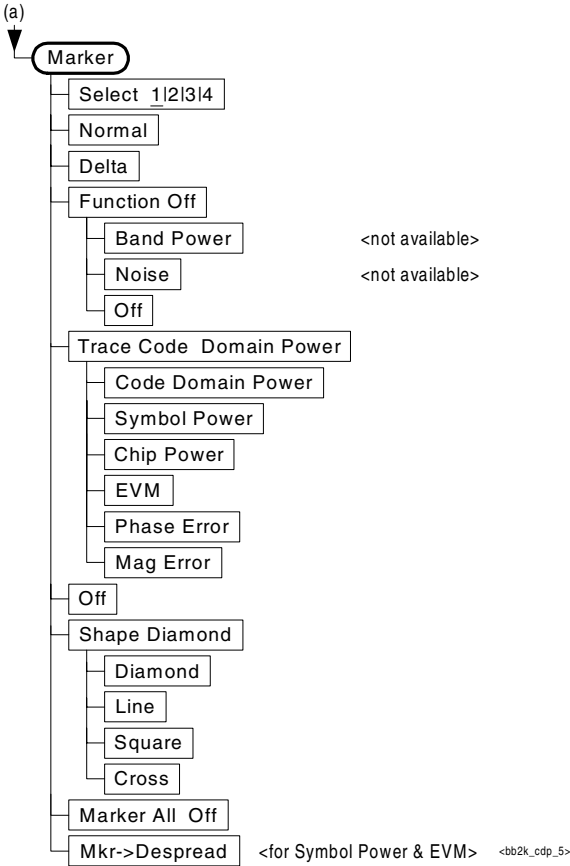

Figure 3-15 Code Domain Measurement Key Flow (5 of 5)



**Figure 3-16 Modulation Accuracy Measurement Key Flow (1 of 3)**

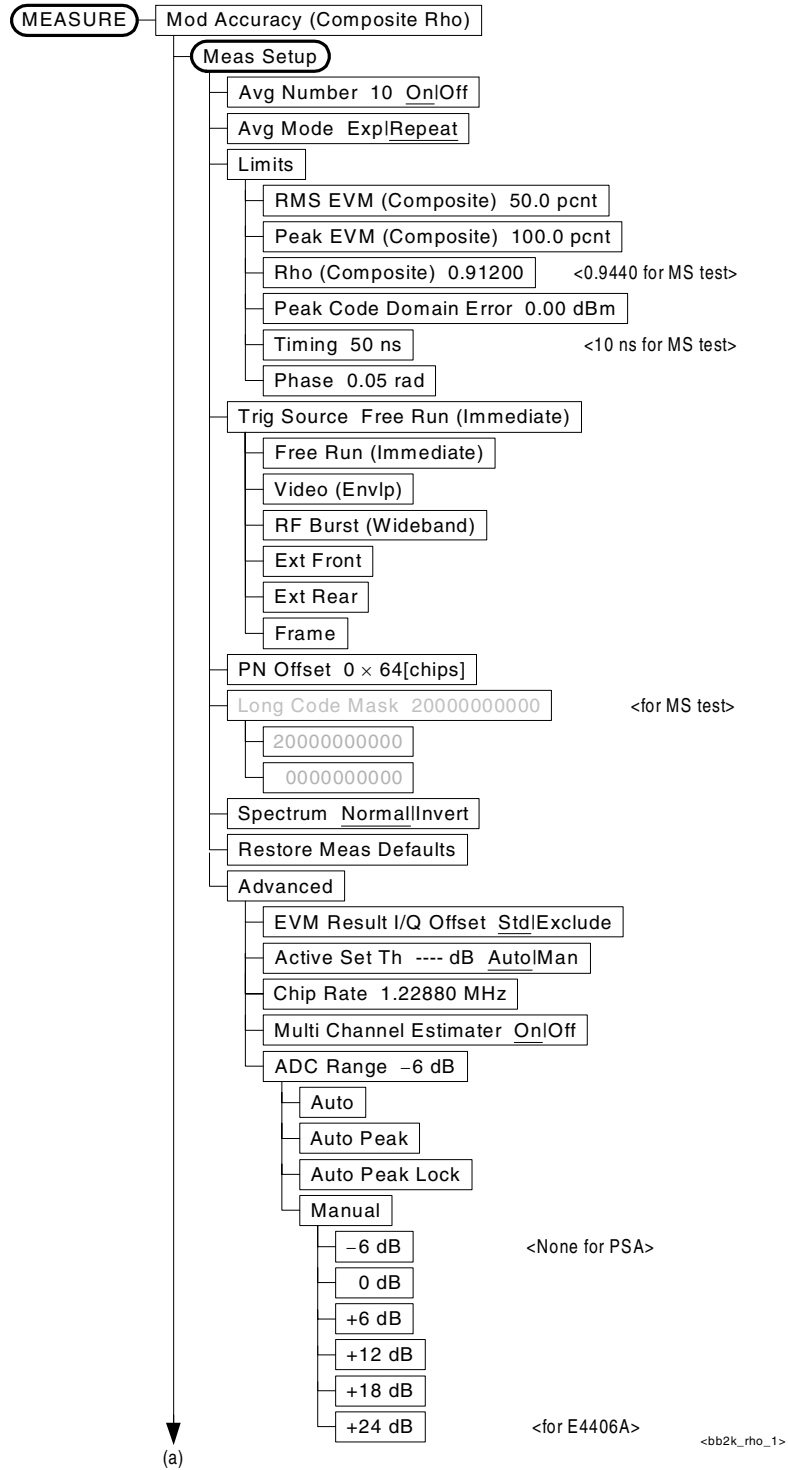

Figure 3-17 Modulation Accuracy Measurement Key Flow (2 of 3)

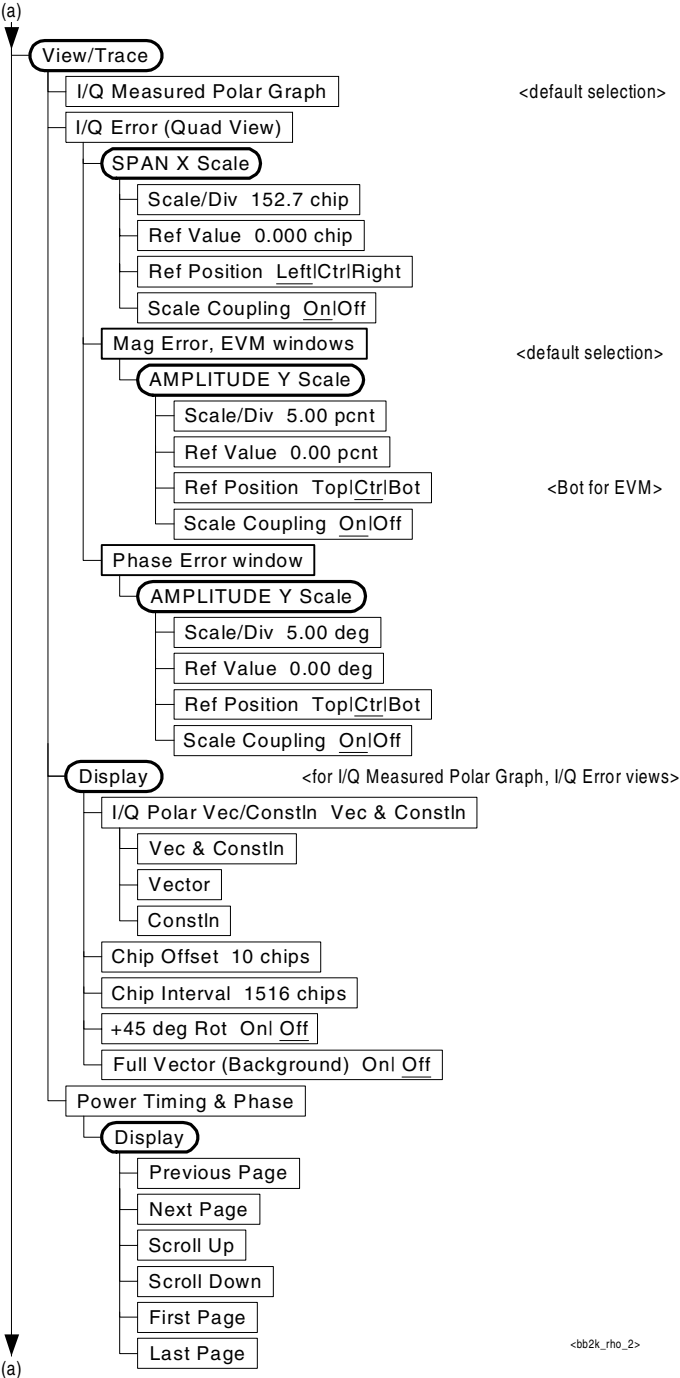

Figure 3-18 Modulation Accuracy Measurement Key Flow (3 of 3)

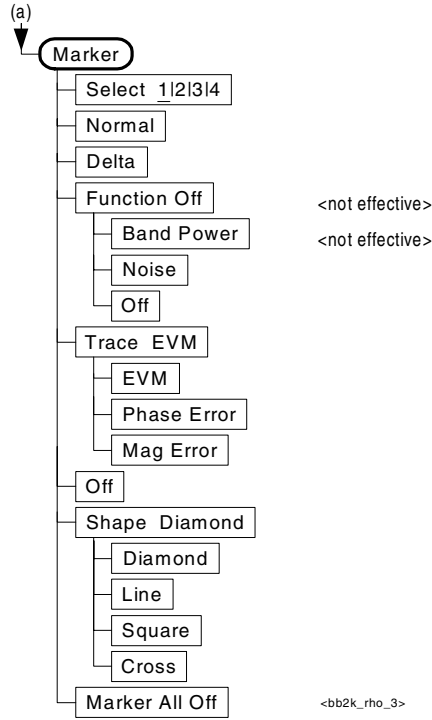

Figure 3-19 QPSK EVM Measurement Key Flow (1 of 2)

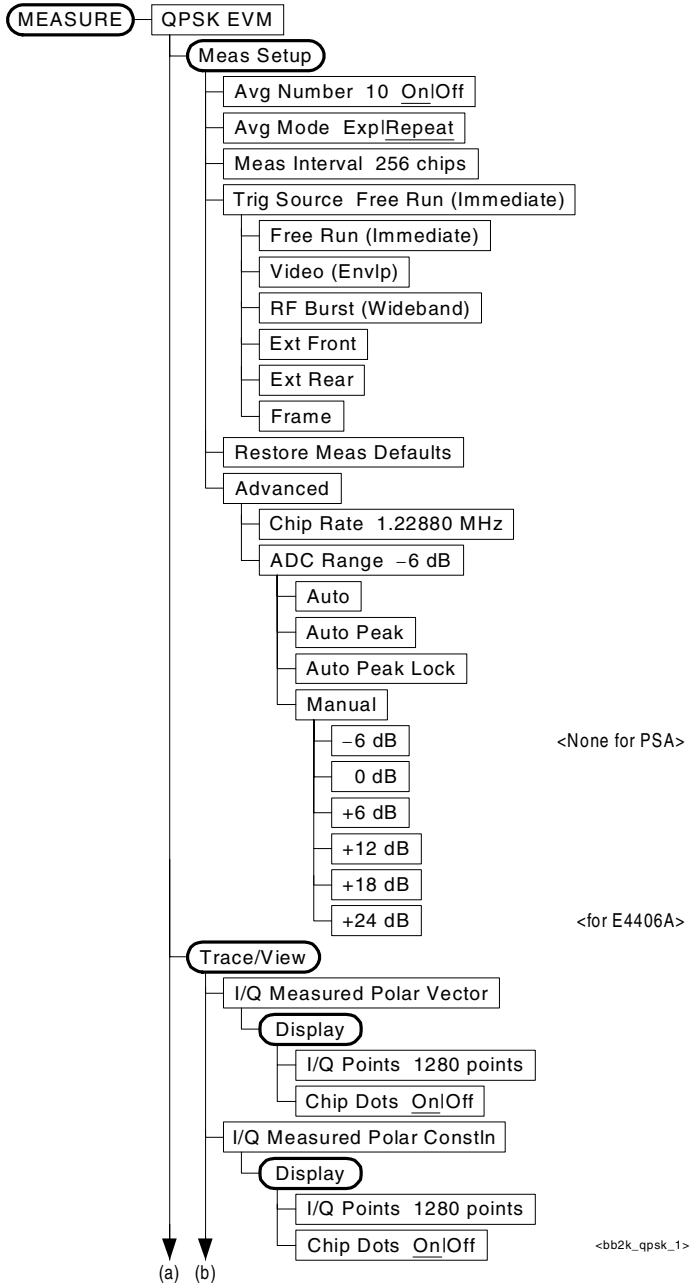
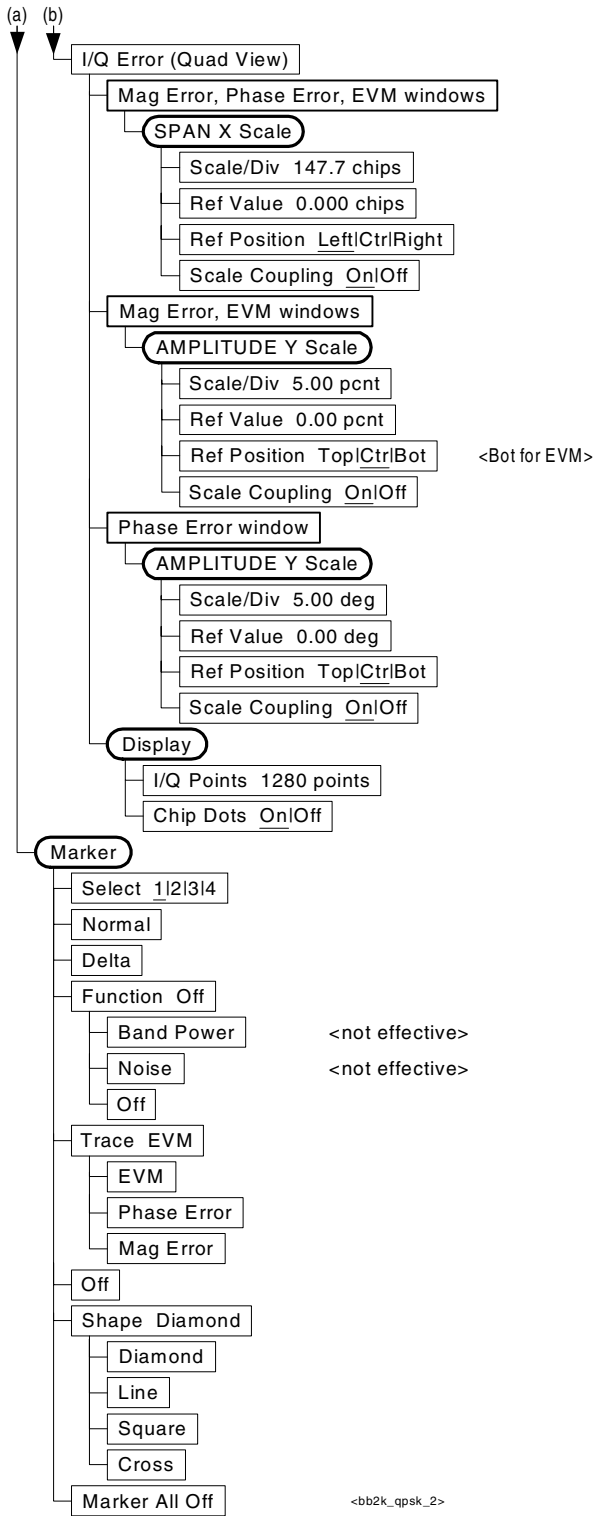
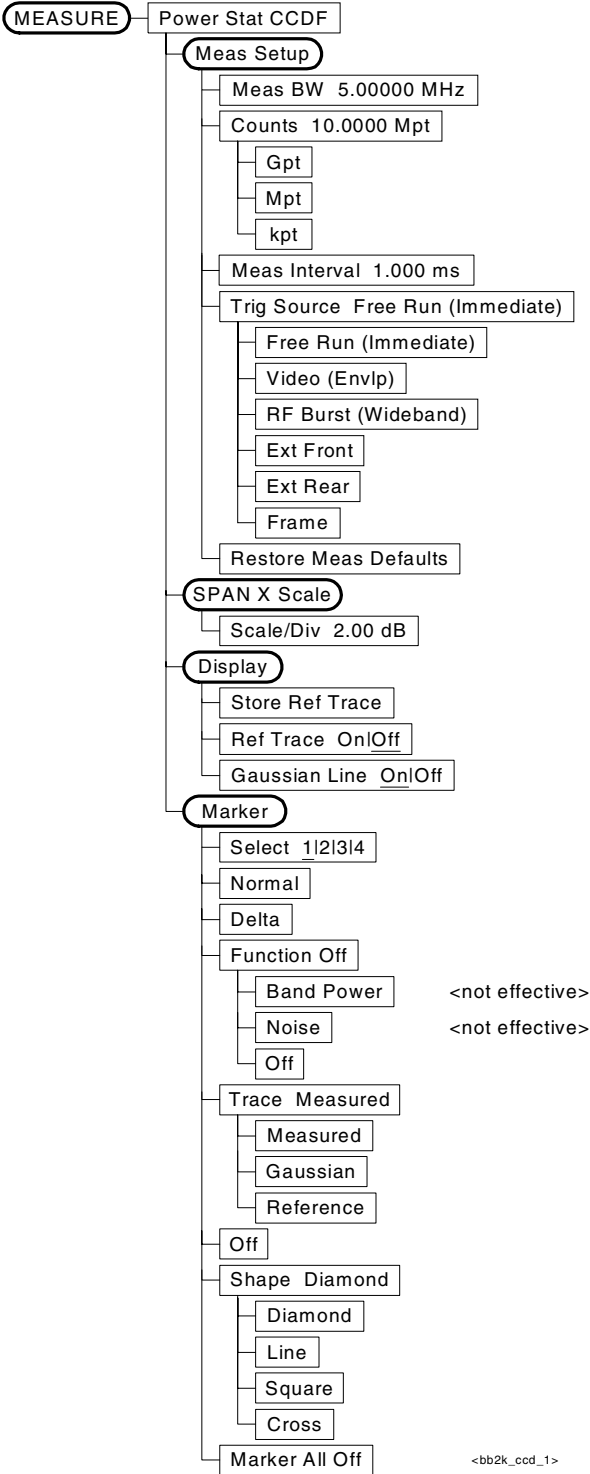

Figure 3-20 QPSK EVM Measurement Key Flow (2 of 2)





**Figure 3-21 Power Statistics CCDF Measurement Key Flow**



**Figure 3-22 Spectrum (Freq Domain) Measurement Key Flow (1 of 4)**

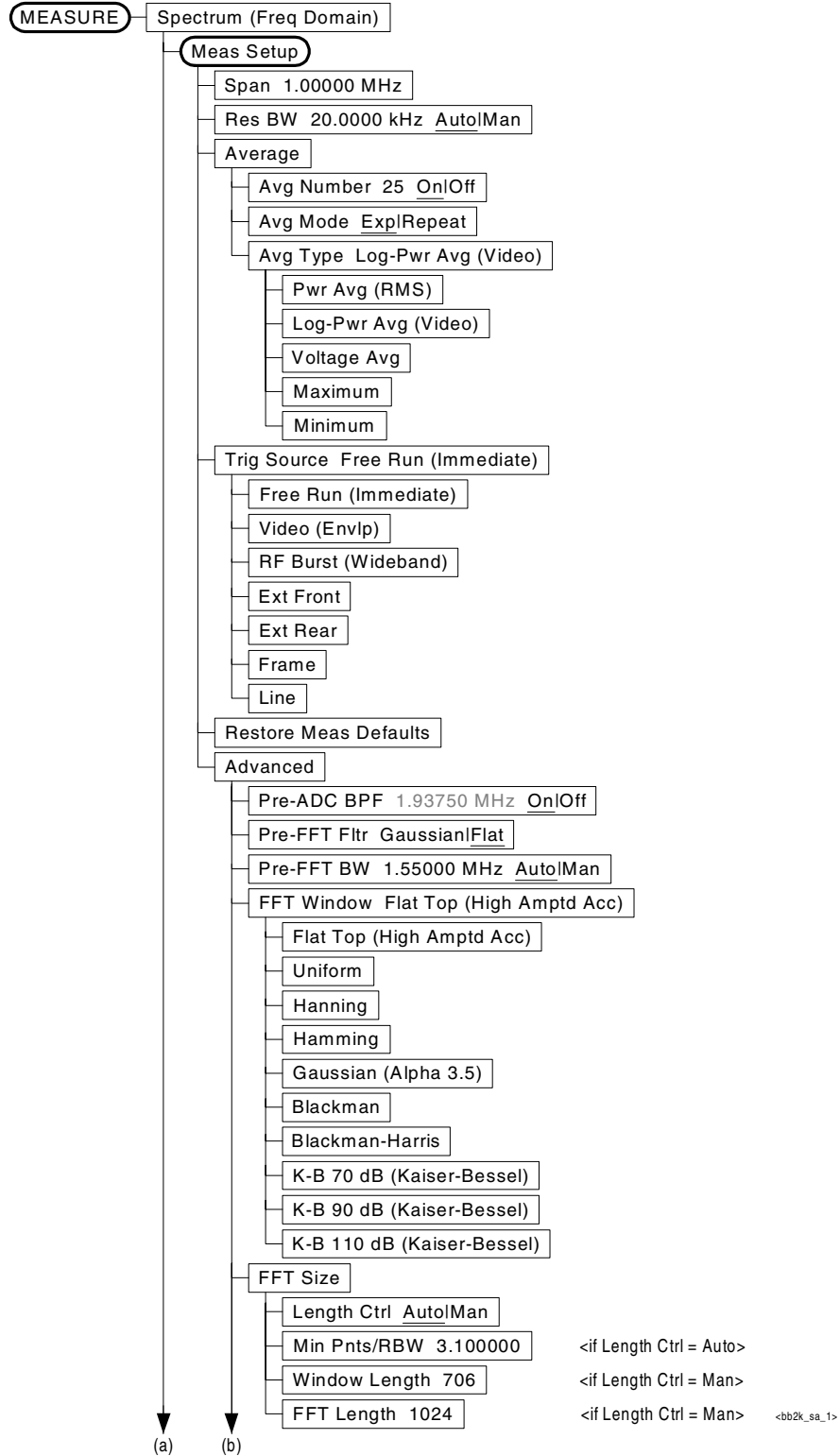
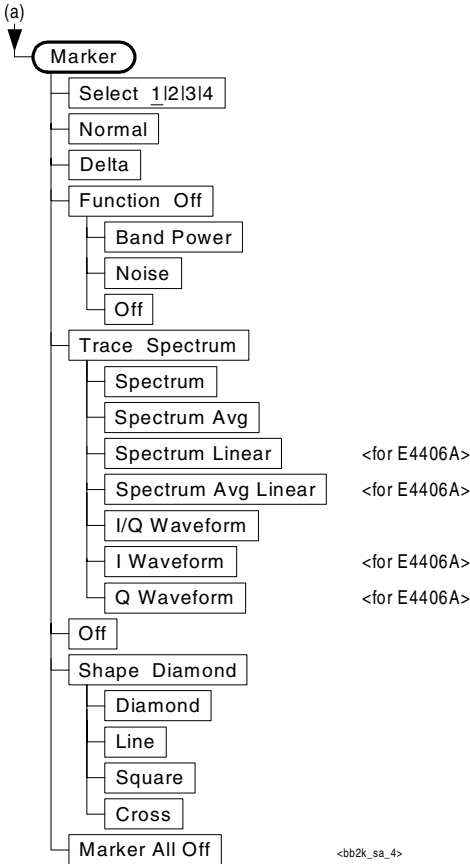





Figure 3-25 Spectrum (Freq Domain) Measurement Key Flow (4 of 4)



**Figure 3-26 Waveform (Time Domain) Measurement Key Flow (1 of 3)**

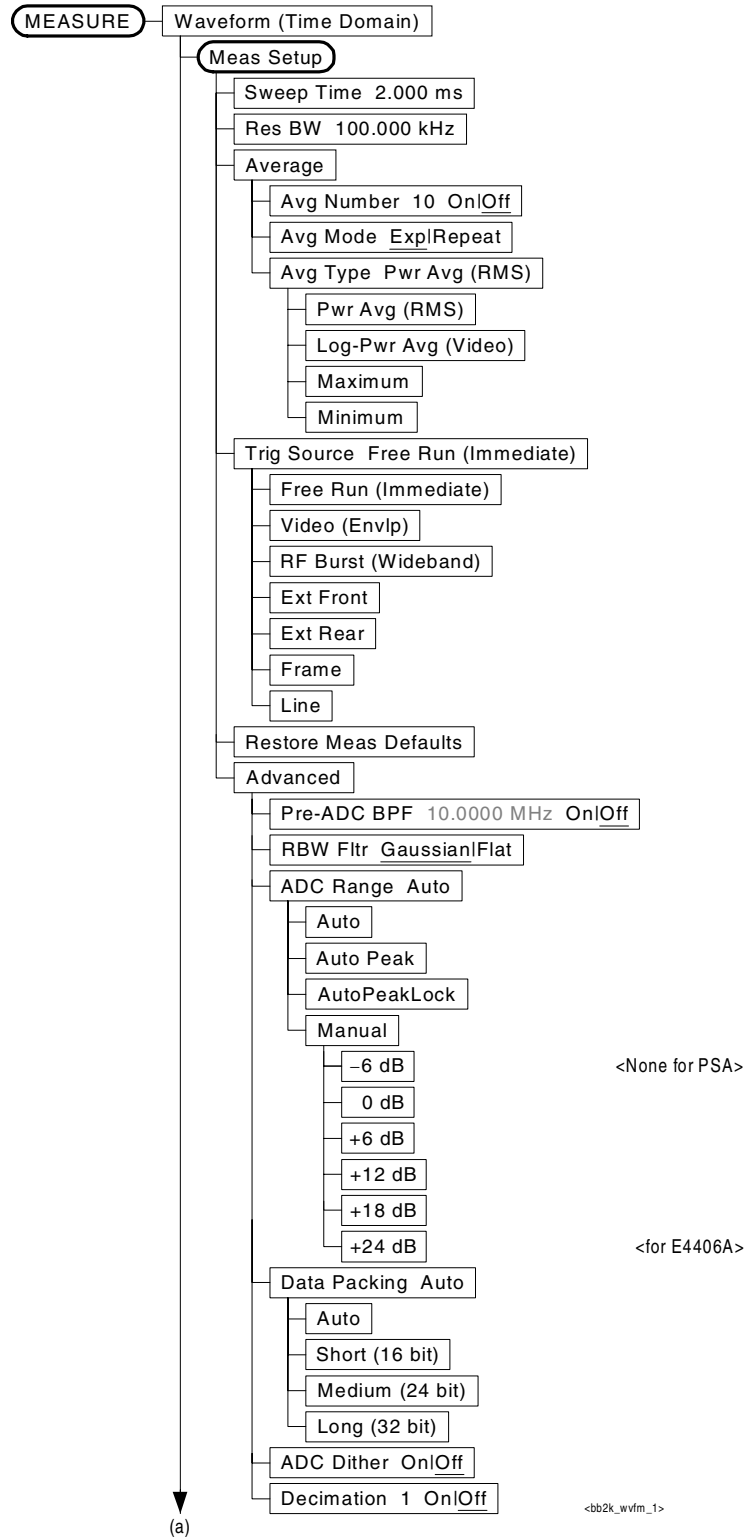
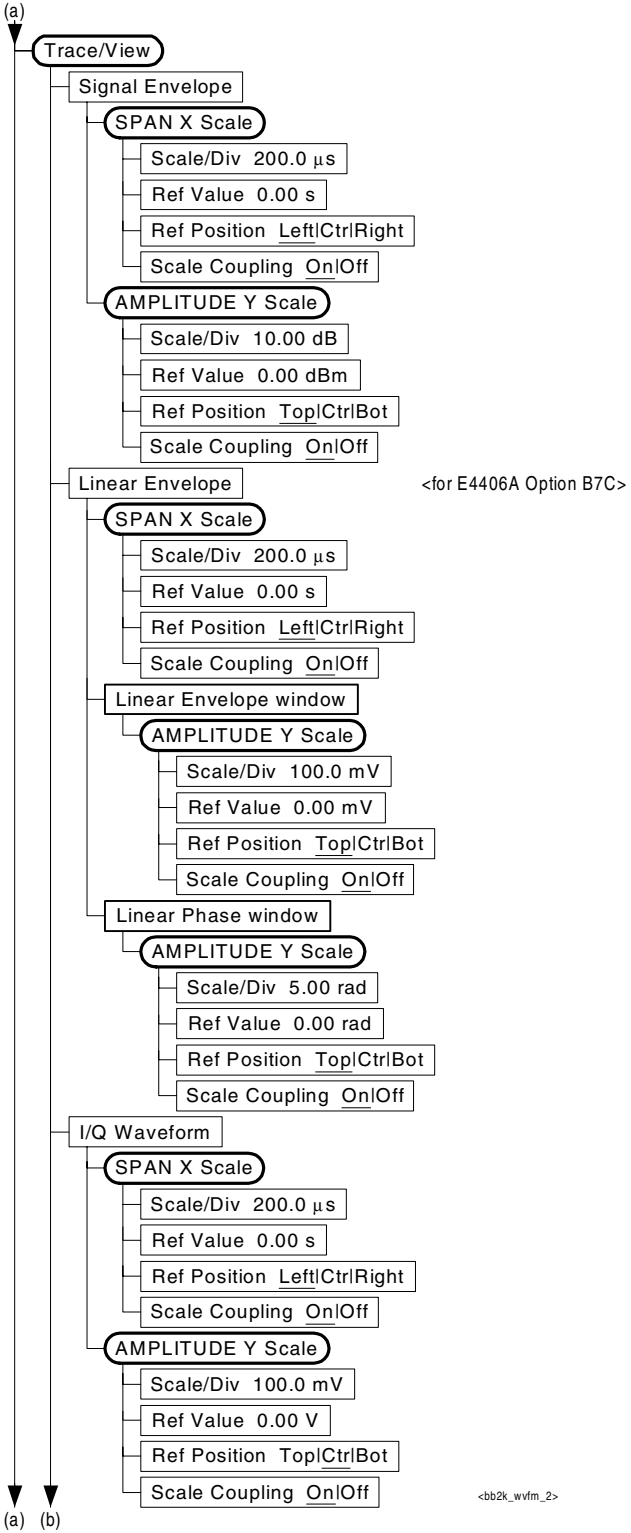
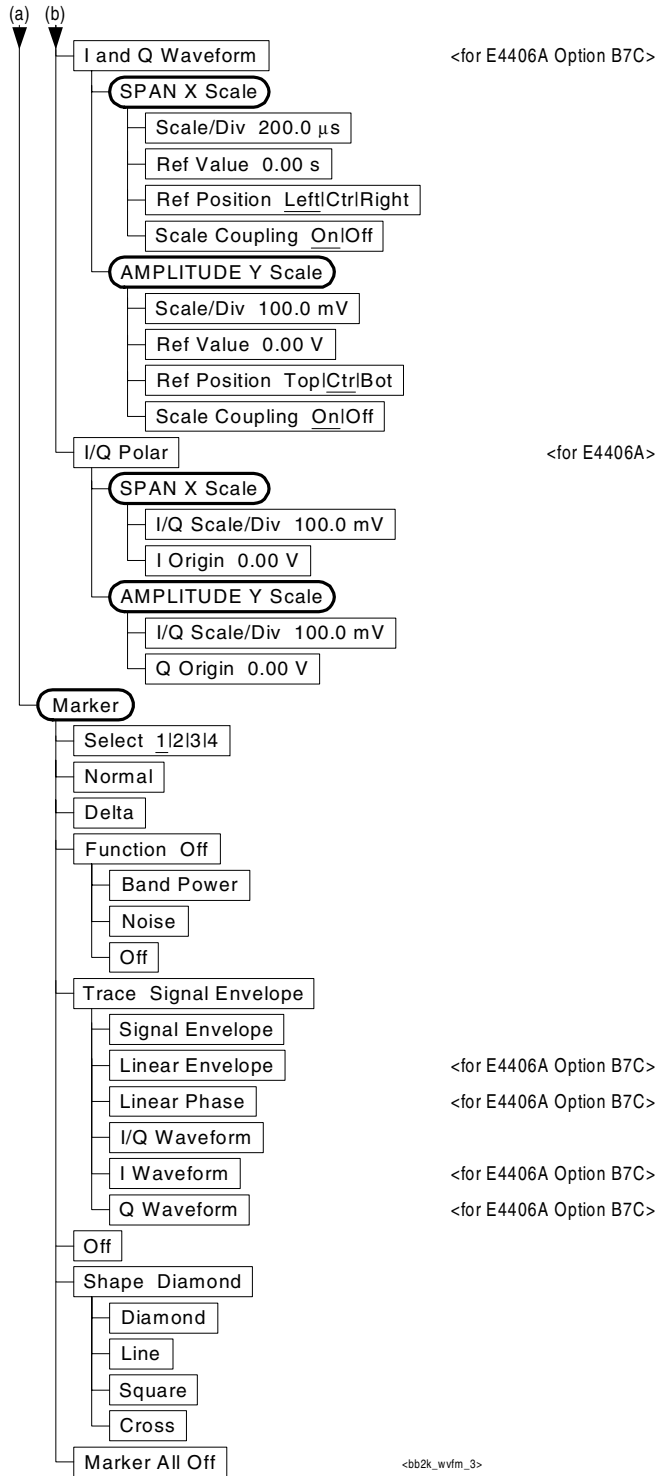

Figure 3-27 Waveform (Time Domain) Measurement Key Flow (2 of 3)



<bb2k\_wvfm\_2>

**Figure 3-28 Waveform (Time Domain) Measurement Key Flow (3 of 3)**





---

## Using Basic Mode on PSA Series

Basic mode is part of Option B7J for the PSA series. Basic mode is *not* related to a particular communications standard. That is, it does not default to measurement settings that are for any specific standard. You may want to use Basic Mode if you are making measurements on a signal that is not part of a specific digital communications standard.

There are two measurements available under the **MEASURE** key in Basic mode:

- Spectrum measurement (frequency domain).
- Waveform measurement (time domain)

These measurements provide a measurement mode that is similar to a standard spectrum analyzer. Unlike the standard analyzer, these measurements are optimized for measuring digitally modulated signals, so they can be used to output the measured I/Q data.

The Spectrum and Waveform measurements are also available in this mode, with the same functionality, so you can refer to this manual for information about using them.

## Installing Optional Measurement Personalities

When you install a measurement personality, you follow a two step process.

1. Install the measurement personality firmware into the instrument memory. See [“Loading an Optional Measurement Personality” on page 116.](#)
2. Enter a license key number that activates the measurement personality. See [“Installing a License Key” on page 117.](#)

Adding additional measurement personalities requires purchasing a retrofit kit for the desired option. The retrofit kit contains the measurement personality firmware and a license key certificate. It documents the license key number that is specific for your option and instrument serial number.

### Why Aren't All the Personality Options Loaded in Memory?

There are many measurement personality options available for use with this instrument. Some versions of instrument hardware may not have enough memory to accommodate all the options that you have ordered. If this is the case you will need to swap the applications in/out of memory, as needed. It may be possible to upgrade your hardware to have more memory. Contact your local sales/service office.

### Available Measurement Personality Options

To order a measurement personality option you need the instrument model number, the host ID and the serial number.

Required Information:	Front Panel Key Path:
Model #: (Ex. E4406A)	
Host ID: _____	<b>System, Show System</b>
Instrument Serial Number: _____	<b>System, Show System</b>

#### NOTE

For PSA, the instrument must have Option B7J in order to use most of the measurement personality options. (cdmaOne, cdma2000, 1xEV-DO, W-CDMA, GSM, EDGE, NADC, PDC.)

<b>Personality Options<sup>a</sup> (for PSA series and E4406A)</b>	<b>Option</b>	<b>File Size (PSA Rev: A.04.00) (E4406A Rev: A.06.00)</b>
cdmaOne measurement personality	<b>BAC</b>	2,000,000 Bytes
NADC measurement personalities (sold with PDC)	<b>BAE</b>	1,300,000 Bytes
PDC measurement personalities (sold with NADC)	<b>BAE</b>	1,400,000 Bytes
W-CDMA measurement personality	<b>BAF</b>	4,700,000 Bytes <sup>b</sup>
cdma2000 measurement personality	<b>B78</b>	4,000,000 Bytes <sup>b</sup>
1xEV-DO measurement personality	<b>204</b>	4,800,000 Bytes <sup>b</sup>
Shared measurement library <sup>c</sup>	n/a	1,400,000 Bytes
<b>PSA only Options:</b>		
Phase noise measurement personality	<b>226</b>	2,800,000 Bytes
Noise Figure measurement personality	<b>219</b>	3,000,000 Bytes
Basic measurement personality with digital demod hardware	<b>B7J</b>	Cannot be deleted
GSM (with EDGE) measurement personality	<b>202</b>	3,400,000 Bytes <sup>b</sup>
HP8566B/HP8568B Programming Code Compatibility <sup>d</sup>	<b>266</b>	650,000 Bytes
<b>E4406A only Options:</b>		
GSM measurement personality	<b>BAH</b>	2,500,000 Bytes
EDGE (with GSM) measurement personality <sup>e</sup>	<b>202</b>	3,400,000 Bytes
iDEN measurement personality	<b>HN1</b>	1,800,000 Bytes
Baseband I/Q Inputs	<b>B7C</b>	n/a (hardware only)

- a. Available as of the print date of this guide.
- b. Some PSA Series personality options use a shared measurement library. You have to add the memory requirements of this library to the value needed for the option. If you are loading multiple personalities that use this library, you only need to add this memory requirement once.
- c. The E4406A personality options use a shared measurement library. You have to add the memory requirements of this library to the value needed for any option.

Setting Up the Mode  
Installing Optional Measurement Personalities

- d. This option is free and does not require a license key.
- e. For instruments that already have Option BAH licensed, order E4406AU Option 252 to add EDGE (with GSM).

## Loading an Optional Measurement Personality

You must load the desired personality option into the instrument memory. Loading can be done from a firmware CD-ROM or the internet location. An automatic loading program comes with the files and runs from your PC.

---

### NOTE

When you add a new option, or update an existing option, you will get the updated version of all your current options since they are reloaded simultaneously. This process may also require you to update the instrument core firmware so that it is compatible with the new option.

---

You may not be able to fit all of the available measurement personalities in instrument memory at the same time. You may need to delete an existing option file from memory and load the one you want. Use the automatic update program that is provided with the files.

The approximate memory requirements for the options are listed above. These numbers are worst case examples. Some options share components and libraries, therefore the total memory usage of multiple options may not be exactly equal to the combined total.

---

### NOTE

For PSA: To facilitate mode switching, you must have some available memory (~500 kB) after loading all your optional measurement personalities. For example, if you have used up most of your free memory saving files of state and/or trace data, your mode switching times can increase to more than a minute.

---

For E4406A, you may want (or need) to add optional memory to load all the different measurement personalities that you want.

Required Information:	Key Path:
Instrument Memory: _____	<b>System, File System</b> (This key is grayed out.) The total amount of memory in your instrument will be the sum of the Used memory and the Free memory.

For E4406A, you can install an update version of core firmware and your licensed options using a LAN connection and your PC. The **Exit Main Firmware** key halts the operation of the instrument firmware so you can install an updated version. Instructions for loading future firmware updates are available from the following internet location:  
<http://www.agilent.com/find/vsa/>

For PSA, you can install an updated version of firmware and your licensed options using a LAN connection and your PC. Instructions for loading future firmware updates are available from the following internet location: <http://www.agilent.com/find/psa/>

## Installing a License Key

To install a license key number for the selected personality option, use the following procedure.

---

**NOTE**

---

You can also use this procedure to reinstall a license key number that has been deleted during an uninstall process, or lost due to a memory failure

For PSA:

1. Press **System, More, More, Licensing, Option** to access the alpha editor. Use this alpha editor to enter letters (upper-case), and the front-panel numeric keys to enter numbers for the option designation. You will validate your option entry in the active function area of the display. Then, press the **Enter** key.
2. Press **License Key** to enter the letters and digits of your license key. You will validate your license key entry in the active function area of the display. Then, press the **Enter** key.
3. Press the **Activate License** key.

For E4406A:

1. Press **System, More, More, Install, Choose Option** to access the alpha editor. Use this alpha editor to enter letters (upper-case), and the front-panel numeric keys to enter numbers for the option designation. You will validate your option entry in the active function area of the display. Then, press the **Done** key.

---

**NOTE**

---

Before you enter the license key for the EDGE Retrofit Option 252, you must already have entered the license key for the GSM Option BAH.

2. Press **License Key** to enter the letters and digits of your license key. You will validate your license key entry in the active function area of the display. Then, press the **Done** key.
3. Press the **Install Now** key. The message “New option keys become active after reboot.” will appear, along with the **Yes/No** menu: press the **Yes** key and cycle the instrument power off and then on to complete your installation process, or press the **No** key to cancel the installation process.

## Viewing a License Key

Measurement personalities purchased with your instrument have been installed and activated at the factory before shipment. You will receive a **License Key** unique to every measurement personality purchased. The license key number is a hexadecimal number specific to your measurement personality, instrument serial number and host ID. It enables you to install, or reactivate that particular personality.

Use the following procedure to display the license key number unique to your personality option that is already installed in your instrument:

For PSA:

Press **System, More, More, Licensing, Show License**. The **System, Personalities** keys show you the license key if the option has been activated.

For E4406A:

Press **System, More, More, Install, Choose Option** to enter the letters/numbers for the option you want. You can see the key on the **License Key** softkey. Press the Done key.

---

**NOTE**

*You will want to keep a copy of your license key number in a secure location. Press **System, More**, then **Personality** for PSA, or **Show System** for E4406A, and print out a copy of the display that shows the license numbers. If you should lose your license key number, call your nearest Agilent Technologies service or sales office for assistance.*

---

## Using the Delete License Key on PSA

This key will make the option unavailable for use, but will not delete it from memory. Write down the 12-digit license key number for the option before you delete it. If you want to use that measurement personality later, you will need the license key number to reactivate the personality firmware.

---

**NOTE**

Using the **Delete License** key does not remove the personality from the instrument memory, and does not free memory to be available to install another option. If you need to free memory to install another option, refer to the instructions for loading firmware updates located at the URL: <http://www.agilent.com/find/psa/>

---

1. Press **System, More, More, Licensing, Option**. Pressing the **Option** key will activate the alpha editor menu. Use the alpha editor to enter the letters (upper-case) and the front-panel numeric keyboard to enter the digits (if required) for the option, then press the **Enter** key. As you enter the option, you will see your entry in the active function area of the display.
2. Press **Delete License** to remove the license key from memory.

## Using the Uninstall Key on E4406A

This key will make the option unavailable for use, but will not delete it from memory. The message “Application Not Licensed” will appear in the Status/Info bar at the bottom of the display. Record the 12-digit license key number for the option before you delete it. If you want to use that measurement personality later, you will need the license key number to reactivate the personality firmware.

---

### NOTE

Using the **Uninstall** key does not remove the personality firmware from the instrument memory, and does not free memory to be available to install another option. If you need to free memory to install another option, refer to the instructions for loading firmware updates available at the URL: <http://www.agilent.com/find/vsa/>

---

1. Press **System, More(1 of 3), More(2 of 3), Uninstall, Choose Option** to access the alpha editor. Use this alpha editor to enter the letters (upper-case), and the front-panel numeric keys to enter the numbers (if required) for the installed option. You will validate your option entry in the active function area of the display. Then, press the **Done** key.
2. Pressing the **Uninstall Now** key will activate the **Yes/No** menu: press the **Yes** key to continue your uninstall process, or press the **No** key to cancel the uninstall process.
3. Cycle the instrument power off and then on to complete the uninstall process.

Setting Up the Mode  
**Installing Optional Measurement Personalities**



---

**4 Making Measurements**

---

## cdma2000 Measurements

This chapter begins with instructions common to all measurements made by the Transmitter Tester, then details all cdma2000 measurements available by pressing the **MEASURE** key. For information specific to individual measurements refer to the sections at the page numbers below.

- “Making the Channel Power Measurement” on page 130
- “Making the Adjacent Channel Power Ratio (ACPR) Measurement” on page 135
- “Making the Intermodulation Measurement” on page 145
- “Making the Spectrum Emission Mask Measurement” on page 151
- “Making the Occupied Bandwidth Measurement” on page 165
- “Making the Code Domain Measurement” on page 170
- “Making the Modulation Accuracy (Composite Rho) Measurement” on page 186
- “Making the QPSK EVM Measurement” on page 198
- “Making the Power Stat CCDF Measurement” on page 207
- “Making the Spectrum (Frequency Domain) Measurement” on page 212
- “Making the Waveform (Time Domain) Measurement” on page 225
- “Using Option B7C Baseband I/Q Inputs” on page 238

All the measurements above are referred to as one-button measurements. When you press the key to select a measurement it will become active, using settings and displays unique to that measurement. Data acquisition will automatically begin when trigger requirements, if any, are met.

## Preparing for Measurements

If you want to set the cdma2000 mode to a known, factory default state, press **Preset**. This will preset the mode setup and all of the measurements to the factory default parameters. You should often be able to make a measurement using these defaults.

### NOTE

Pressing the **Preset** key does not switch instrument modes.

To preset only the parameter settings that are specific to the selected measurement, press **Meas Setup, More, Restore Meas Defaults**. This will reset the measurement setup parameters, for the currently selected measurement only, to the factory defaults.

### Initial Setup

Before making a measurement, make sure the mode setup and frequency channel parameters are set to the desired settings. Refer to the sections [“Changing the Mode Setup” on page 75](#) and [“Changing the Frequency Channel” on page 83](#).

For PSA Option 1DS, see [“Configuring the Input Condition” on page 75](#) for details of **Int Preamp** and **Attenuator** operation.

### Measurement Selection

The **MEASURE** front-panel key accesses the menu to select one of the following measurements:

- **Channel Power** - Press this key to make channel power measurements. This is the in-channel power measurement. The channel power graph is displayed in the graph window and both the absolute channel power and mean power spectral density are shown in the text window.

For E4406A Option B7C, this measurement is available for use with either the RF input or Baseband I/Q inputs. For detailed operation, see [“Using Option B7C Baseband I/Q Inputs” on page 238](#).

- **ACPR** - Press this key to make adjacent channel power ratio (ACPR) measurements. This is the out-of-channel measurement. The following windows are available:
  - Bar graph display to show a histogram of powers within the integration bandwidth
  - Spectrum display to show a power distribution curve, like a swept-frequency spectrum analyzer, relative to the center frequency power of the carrier signal.

For E4406A Option B7C, if **Input Port** is set to **I/Q**, this measurement is NOT available.

- **Intermod** - Press this key to make intermodulation products measurements. Three measurement modes are available as follows:
  - Auto - Automatically identifies one of two modes between two-tone or transmit intermodulation products.
  - Two-tone - Measurements are made assuming two signals present in the span are the two tone signals.
  - Transmit IM - Measurements are made assuming the lower frequency signal to be the modulated transmitted signal and the higher frequency signal to be the tone signal.

For E4406A Option B7C, if **Input Port** is set to **I/Q**, this measurement is NOT available.

- **Spectrum Emission Mask** - Press this key to make spectrum emission mask measurements. The measurement mask is configurable with flat and sloped lines according to the radio specifications. Spurious emission measurements can be done with some restrictions from the upper frequency bandwidth by selecting **Region** in **Spectrum Segment**.

For E4406A Option B7C, if **Input Port** is set to **I/Q**, this measurement is NOT available.

- **Occupied BW** - Press this key to make occupied bandwidth measurements. The frequency bandwidth that contains 100.0% of the total power is measured first, and then 99.0% of the frequency bandwidth is calculated as the measurement result.

For E4406A Option B7C, this measurement is available for use with either the RF input or Baseband I/Q inputs. For detailed operation, see [“Using Option B7C Baseband I/Q Inputs” on page 238](#).

- **Code Domain** - Press this key to make code domain power (CDP) measurements. The amount of power in each code channel is displayed. The following windows are available:
  - Power graph and metrics to show the code domain power and the summary data
  - Quad view of the I/Q errors in graphs for the spread rate selected, and the summary data
  - Quad view of the code domain power, the selected symbol power vs. symbol rate, and the selected I/Q symbol power polar vector graphs, and the summary data
  - Triad view of the code domain power and the selected symbol power graphs, and the selected demodulated bits stream text

For E4406A Option B7C, this measurement is available for use with either the RF input or Baseband I/Q inputs. For detailed operation,

see [“Using Option B7C Baseband I/Q Inputs”](#) on page 238.

- **Mod Accuracy (Composite Rho)** - Press this key to make modulation accuracy (composite rho) measurements. The input signal should contain the Pilot channel. This is essentially a code domain power measurement with more than one active channel. The following windows are available:
  - Polar vector and/or constellation graph of the I/Q demodulated signals and the summary data
  - Quad view for the I/Q errors in graphs and the summary data
  - Power, timing, and phase table to list the measurement results for Code, Power (dB), Timing (ns), Phase (rad), and CDE (dB).

For E4406A Option B7C, this measurement is available for use with either the RF input or Baseband I/Q inputs. For detailed operation, see [“Using Option B7C Baseband I/Q Inputs”](#) on page 238.

- **QPSK EVM** - Press this key to make QPSK error vector magnitude (EVM) measurements. The following windows are available:
  - Polar vector graph of the I/Q demodulated signals and the summary data
  - Polar constellation graph of the I/Q demodulated signals and the summary data
  - Quad view for the I/Q errors and the summary data

For E4406A Option B7C, this measurement is available for use with either the RF input or Baseband I/Q inputs. For detailed operation, see [“Using Option B7C Baseband I/Q Inputs”](#) on page 238.

- **Power Stat CCDF** - Press this key to make power statistics, Complementary Cumulative Distribution Function (CCDF) measurements. This is helpful to observe the time domain characteristics of a spread spectrum signal that can significantly affect the ACPR measurement results for a given UUT.

For E4406A Option B7C, this measurement is available for use with either the RF input or Baseband I/Q inputs. For detailed operation, see [“Using Option B7C Baseband I/Q Inputs”](#) on page 238.

- **Spectrum (Freq Domain)** - Press this key to make frequency domain spectrum measurements. The following windows are available:
  - Spectrum graph with the semi-log graticules and I/Q waveform graph with the linear graticules
  - Linear spectrum graph with the linear graticules (for E4406A)
  - I and Q waveform graphs with the linear graticules (for E4406A)
  - I/Q polar graph of the baseband I/Q signals with the linear graticules (for E4406A)

For E4406A Option B7C, this measurement is available for use with either the RF input or Baseband I/Q inputs. For detailed operation, see [“Using Option B7C Baseband I/Q Inputs” on page 238](#).

- **Waveform (Time Domain)** - Press this key to make time domain waveform measurements. The following windows are available:
  - Signal Envelope graph with semi-log graticules and summary data
  - Linear Envelope graph with signals measured as voltages and Linear Phase graph with the linear graticules (for E4406A Option B7C, active when using Baseband IQ inputs)
  - I/Q waveform graph and summary data
  - I and Q Waveform graph of the individual I and Q signals (for E4406A Option B7C, active when using Baseband IQ inputs)
  - I/Q polar graph of the baseband I/Q signals (for E4406A)

For E4406A Option B7C, this measurement is available for use with either the RF input or Baseband I/Q inputs. For detailed operation, see [“Using Option B7C Baseband I/Q Inputs” on page 238](#).

## Measurement Control

The **Meas Control** front-panel key accesses the menu to control processes that affect the running of the current measurement.

- **Restart** - Press this key to repeat the current measurement from the beginning, while retaining the current measurement settings. When pressed, the scale coupling function is activated for an appropriate display to the current input signal level. This is equivalent to the **Restart** front-panel key.
- **Measure** - Press this key (not to be confused with the **MEASURE** front-panel key which has a different function) to toggle the measurement state between **Single** and **Cont** (continuous). When set to **Single**, the measurement will continue until it has reached the specified number of averages set by the average counter. When set to **Cont**, the measurement will run continuously and execute averaging according to the current average mode, either repeat or exponential. The default setting is **Cont** for most measurements, but the Code Domain and Power Stat CCDF measurements have **Single** as the default.
- **Pause** - Press this key to pause the current measurement until you reactivate the measurement. Once toggled, the label of the **Pause** key changes to read **Resume**. The **Resume** key, once pressed, continues the active measurement from the point at which it was paused.

## Measurement Setup

The **Meas Setup** key accesses the features that enable you to adjust parameters of the current measurement, such as span and resolution bandwidth, according to the measurement function. You will also use the **Meas Setup** menu to access the **Average**, **Limit Test**, **Advanced** and other feature menus.

The following measure setup features can be used with many or all measurements:

- **Restore Meas Defaults** - Allows you to preset only the settings that are specific to the selected measurement by pressing **Meas Setup**, **More**, **Restore Meas Defaults**. This will set the measure setup parameters, for the currently selected measurement only, to the factory defaults.

### Averaging

Selecting one of the averaging keys in the **Meas Setup** menu will allow you to modify the average number and averaging mode you use for the currently selected measurement. For spectrum (frequency domain) and waveform (time domain) measurements the **Average** key activates the following menu.

- **Avg Number** - Allows you to change the number of N averages to be made.
- **Avg Mode** - Allows you to toggle the averaging mode between **Exp** (exponential) and **Repeat**. This selection only effects on the averaging result after the number of N averages is reached. The N is set using the **Avg Number** key.
  - **Normal averaging:** Normal (linear) averaging is always used until the specified number of N averages is reached. When the **Measure** key under **Meas Control** is set to **Single**, data acquisition is stopped when the number of N averages is reached, thus **Avg Mode** has no effect in the single measurement mode.
  - **Exponential averaging:** When **Measure** is set to **Cont**, data acquisition will continue indefinitely. Exponential averaging is used with a weighting factor of N (the displayed count of averages stops at N). Exponential averaging weights new data more heavily than old data, which allows tracking of slow-changing signals. The weighting factor N is set using the Avg Number key.
  - **Repeat averaging:** When **Measure** is set to **Cont**, data acquisition will continue indefinitely. After the number of N averages is reached, all previous result data is cleared and the average count displayed is set back to 1. This is equivalent to being in **Measure Single** and pressing the **Restart** key each time the single measurement finishes.
- **Avg Type** - Allows you to access the menu of the following average

types only for making spectrum (frequency domain) and waveform (time domain) measurements:

**Pwr Avg (RMS)** - Executes the true power averaging which is equivalent to taking the rms of the voltage. This is the most accurate type.

**Log-Pwr Avg (Video)** - Simulates the traditional spectrum analyzer type of averaging by calculating the log of the power.

**Voltage Avg** - Executes the voltage averaging.

**Maximum** - Executes the maximum voltage averaging by capturing peak data.

**Minimum** - Executes the minimum voltage averaging.

### Selecting a Trigger Source

Changing the selection in the **Trig Source** menu alters the trigger source for the selected measurement only. Not all of the selections are always available for all measurements. Also, some cdma2000 measurements do not require a trigger. Choose one of the following trigger sources depending on the selected measurement:

---

#### NOTE

The **RF Burst**, **Video (Envlp)**, **Ext Front**, and **Ext Rear** keys found under the **Trigger** menu enable you to change the default settings of the delay, level and slope for each of these trigger sources.

For E4406A Option B7C Baseband I/Q Inputs, if **Input Port** is set to **I/Q**, the **I/Q Level** key is activated under the **Trigger** menu for the **Channel Power**, **Occupied BW**, **Code Domain**, **Mod Accuracy (Composite Rho)**, **QPSK EVM**, **Power Stat CCDF**, **Spectrum (Freq Domain)**, and **Waveform (Time Domain)** measurements.

---

- **Free Run (Immediate)** - A trigger occurs at the time the data is requested, completely asynchronous with the RF or IF signal.
- **Video (Envlp)** - An internal IF envelope trigger that occurs at the absolute threshold level of the IF signal level.
- **RF Burst (Wideband)** - An internal wideband RF burst trigger that has the automatic level control for burst signals. It triggers at the level that is set relative to the peak RF signal (12 MHz bandwidth) input level.
- **Ext Front** - Activates the front-panel external trigger input (**EXT TRIGGER INPUT**) port. The external signal must be between  $-5.00$  and  $+5.00$  V with 1 or 10 mV resolution.
- **Ext Rear** - Activates the rear-panel external trigger input (**TRIGGER IN**) port. The external signal must be between  $-5.00$  and  $+5.00$  V with 1 or 10 mV resolution.



- **Frame** - Uses the internal frame clock to generate a trigger signal. The clock parameters are controlled under the **Mode Setup** key or the measurement firmware, but not both. Refer to the specific measurement section for details.
- **Line** - Sets the trigger to the internal line mode. Sweep triggers occur at intervals synchronous to the line frequency. See the specific measurement section for details.

### Using the Trigger Outputs

The rear panel **TRIGGER 1 OUT** and **TRIGGER 2 OUT** connectors are coupled to the selected trigger source. These trigger outputs are always on at the rising edge with a pulse width of at least 1  $\mu$ s.

---

## Making the Channel Power Measurement

### Purpose

The Channel Power measurement is a common test used in the wireless industry to measure the total transmitted power of a radio within a defined frequency channel. This procedure measures the total power within the defined channel for cdma2000. This measurement is applied to design, characterize, evaluate, and verify transmitters and their components or devices for base stations and mobile stations.

### Measurement Method

The Channel Power measurement reports the total transmitted power within the channel bandwidth, 1.23000 MHz for the cdma2000 mode. The measurement acquires a number of points representing the input signal in the time domain. It transforms this information into the frequency domain using FFT and then calculates the channel power. The effective resolution bandwidth of the frequency domain trace is proportional to the number of points acquired for FFT. The fastest FFT process is achieved using a number of acquired points that is a power of 2 (for example: 64, 128, 512).

Since the measurement is optimized for speed and accuracy, you are permitted to change only the number of acquired data points in powers of 2, not the actual resolution bandwidth which is shown in gray. However, if absolute sweep time is required, it can be changed to the user's specific value at the expense of reduced speed. At no time will both sweep time and data points be set to manual because of conflicting parameter settings. This flexibility is available through the **Advanced** menu of the channel power measurement.

To improve repeatability, you can increase either the number of averages or the number of data points with longer time record length. The channel power graph is shown in the graph window, while the absolute channel power in dBm and the mean power spectral density in dBm/Hz are shown in the text window.

For E4406A Option B7C, this measurement is available for use with either the RF input or baseband I/Q inputs. For detailed operation, see the "Using Option B7C Baseband I/Q Inputs" section.

## Making the Measurement

**NOTE**

The factory default settings provide a good starting point. You may want to change some of the settings. Press **Meas Setup, More, Restore Meas Defaults** at any time to return all parameters for the current measurement to their default settings.

Select the desired center frequency as described in “Changing the Frequency Channel”.

Press **MEASURE, Channel Power** to immediately make a channel power measurement.

To change any of the measurement parameters from the factory default values, refer to the “Changing the Measurement Setup” section for this measurement.

For E4406A Option B7C, to make channel power measurements using baseband I/Q input signals, refer to the “Using Option B7C Baseband I/Q Inputs” section.

## Results

The following figure shows an example result of Channel Power measurement result. The channel power graph is shown in the graph window. The absolute channel power and its mean power spectral density are shown in the text window.

**Figure 4-1**

**Channel Power Measurement**

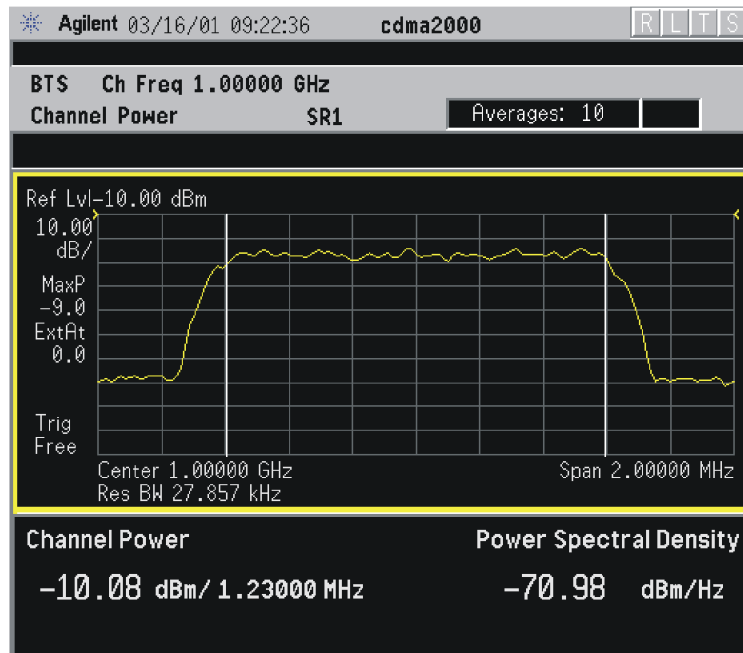

\*Meas Setup: Factory default settings

\*Input signal: -10.00 dBm, 9 channels of SR1, cdma2000 Rev 8

## Changing the Measurement Setup

The next table shows the factory default settings for channel power measurements.

**NOTE** Parameters under the **Advanced** key seldom need to be changed. Any changes from the factory default values may result in invalid measurement data.

**Table 4-1 Channel Power Measurement Defaults**

Measurement Parameter	Factory Default Condition
Meas Setup:	
Avg Number	20; On
Avg Mode	Repeat
Integ BW <sup>a</sup>	1.23000 MHz
Chan Power Span <sup>a</sup>	2.00000 MHz
<b>Advanced</b>	
Sweep Time	68.27 μs; Auto
Data Points	512; Auto
Res BW (grayed out)	27.857 kHz (grayed out)
Trig Source	Free Run (Immediate)

a. The Integ BW setting proportionally changes the Chan Power Span setting up to 10 MHz.

Make sure the **Channel Power** measurement is selected under the **MEASURE** menu. The **Meas Setup** key accesses the menu which allows you to modify the average number and average mode for this measurement.

In addition, the following parameters can be changed according to your measurement requirements:

- **Integ BW** - Allows you to specify the integration bandwidth in which the power is measured. The range is 1.000 kHz to 10.0000 MHz with 1 Hz resolution. Since **Integ BW** is coupled to **Chan Power Span** in the factory default condition, if you change the integration bandwidth setting, the channel power span setting changes by a proportional amount, 1.626 times the integration bandwidth, until a limit value is reached.
- **Chan Power Span** - Allows you to set the frequency span for the

channel power measurement. The range is 1.000 kHz to 10.0000 MHz with 1 Hz resolution. This span is used for the current integration bandwidth setting. Since **Chan Power Span** is coupled to **Integ BW** in the factory default condition, if you change the integration bandwidth setting, the channel power span setting changes by a proportional amount, 1.626 times the integration bandwidth, until a limit value is reached. However, the channel power span can be individually set.

- **Advanced** - Allows you to access the following menu to modify the channel power measurement parameters:
  - **Sweep Time** - Allows you to manually change the sweep time and also to toggle the sweep time control between **Auto** and **Man** (manual). The range is 1.0  $\mu$ s to 50.00 ms with 1  $\mu$ s resolution. If set to **Auto**, the sweep time derived from the data point setting is shown on this key regardless of the manual entry range.
  - **Data Points** - Allows you to select the number of data points and also to toggle the data point control between **Auto** and **Man** (manual). The range is 64 to 65536 with the acceptable entry in powers of 2 (for example: 64, 128, 512). If set to **Auto**, the optimum number of points is determined for the fastest measurement time with acceptable repeatability. The minimum number of points that could be used is determined by the sweep time and the sampling rate. You can increase the length of the measured time record (capture more of the burst) by increasing the number of points, but the measurement will take longer.
  - **Res BW** - Shows information on the resolution bandwidth derived from the sweep time. This key is always grayed out.
  - **Trig Source** - Allows you to choose a trigger source from **Free Run (Immediate)**, **Video (Envlp)**, **RF Burst**, **Ext Front**, **Ext Rear**, **Frame**, or **Line**.

## Changing the Display

The **AMPLITUDE Y Scale** key accesses the menu to set the desired vertical scale and associated settings:

- **Scale/Div** - Allows you to enter a numeric value to change the vertical display sensitivity. The range is 0.10 to 20.00 dB with 0.01 dB resolution. The default setting is 10.00 dB. However, since the **Scale Coupling** default is **On**, this value is automatically determined by the measurement result. When you set a value manually, **Scale Coupling** automatically changes to **Off**.
- **Ref Value** - Allows you to set the absolute power reference value ranging from -250.00 to 250.00 dBm with 0.01 dB resolution. The default setting is 10.00 dBm. However, since the **Scale Coupling** default is **On**, this value is automatically determined by the

measurement result. When you set a value manually, **Scale Coupling** automatically changes to **Off**.

- **Ref Position** - Allows you to set the display reference position to either **Top**, **Ctr** (center), or **Bot** (bottom). The default setting is **Top**.
- **Scale Coupling** - Allows you to toggle the scale coupling function between **On** and **Off**. The default setting is **On**. Upon pressing the **Restart** front-panel key or **Restart** softkey under the **Meas Control** menu, the scale coupling function automatically determines the scale per division and reference values based on the measurement results. When you set a value to either **Scale/Div** or **Ref Value** manually, **Scale Coupling** automatically changes to **Off**.

## Using the Marker

The **Marker** key is not available for this measurement function.

## Troubleshooting Hints

If an external attenuator is used, be sure to use the **Ext RF Atten** key to include the attenuation value in the displayed measurement result.

The channel power measurement, along with the adjacent channel power ratio measurement and spectrum measurements, can reveal the effects of degraded or defective parts in the transmitter section of the UUT. The following are areas of concern which can contribute to performance degradation:

- DC power supply control of the transmitter power amplifier, RF power control of the pre-power amplifier stage, and/or I/Q control of the baseband stage.
- Gain and output power levels of the power amplifier, caused by degraded gain control and/or increased distortion.
- Amplifier linearity.

---

## Making the Adjacent Channel Power Ratio (ACPR) Measurement

### Purpose

Adjacent Channel Power Ratio (ACPR), as it applies to cdma2000, is the power contained in a specified frequency channel bandwidth relative to the total carrier power. It may also be expressed as a ratio of power spectral densities between the carrier and the specified offset frequency band.

As a composite measurement of out-of-channel emissions, ACPR combines both in-band and out-of-band specifications to provide useful figures-of-merit for spectral regrowth and emissions produced by components and circuit blocks without the rigor of performing a full spectrum emissions mask measurement.

To maintain a quality call by avoiding channel interference, it is important to measure and reduce any adjacent channel leakage power transmitted from a mobile phone. The characteristics of adjacent channel leakage power are mainly determined by the transmitter design, particularly the low-pass filter.

### Measurement Method

This ACPR measurement analyzes the total power levels within the defined carrier bandwidth and at given frequency offsets on both sides of the carrier frequency. This measurement requires the user to specify measurement bandwidths of the carrier channel and each of the offset frequency pairs up to 5. Each pair may be defined with unique measurement bandwidths.

It uses an integration bandwidth (IBW) method that performs a time domain data acquisition and applies FFT to get a frequency domain trace. In this process, the channel integration bandwidth is analyzed using the automatically defined resolution bandwidth (RBW), which is much narrower than the channel bandwidth. The measurement computes an average power of the channel over a specified number of data acquisitions, automatically compensating for resolution bandwidth and noise bandwidth.

If **Total Pwr Ref** is selected as the measurement type, the results are displayed as relative power in dBc and as absolute power in dBm. If **PSD Ref** (Power Spectral Density Reference) is selected, the results are displayed as relative power in dB, and as absolute power in dBm/Hz.

### Recommended Offset Frequencies and Reference Bandwidths

While the user sets the specific offsets and reference bandwidths, the

radio specifications recommend some common setups as shown in the following table. The offset frequency is titled as *Offset to Edge* in the measurement result window. For example, if the measurement bandwidth is set to 30 kHz, the first offset center frequency can be 765 kHz and the offset to edge frequency can be 750 kHz.

Table 4-2

ACPR Setup Recommendation

Band	Test Device	Offset Frequency	Integration Bandwidth	Result Reference
cdma2000	Mobile	±900.0 kHz	30 kHz	Total Power in 1.230 MHz
		±1.995 MHz	30 kHz	
	Base	±765.0 kHz	30 kHz	
		±1.995 MHz	30 kHz	

## Making the Measurement

The factory default settings provide a good starting point. For special requirements, you may want to change some of the settings. Press **Meas Setup, More, Restore Meas Defaults** at any time to return all parameters for the current measurement to their default settings.

Select the desired center frequency as described in the “Changing the Frequency Channel” section.

Press **MEASURE, ACPR** to immediately make an adjacent channel power ratio measurement.

To change any of the measurement parameters from the factory default values, refer to the “Changing the Measurement Setup” section of this measurement.

## Results

The following figure shows an example result of ACPR (*Total Pwr Ref*) measurements in the bar graph window. The absolute and relative power levels on both sides of the carrier frequency are displayed in the graphic window and text window.



Figure 4-2

cdma2000 ACPR Measurement - FFT Bar Graph View

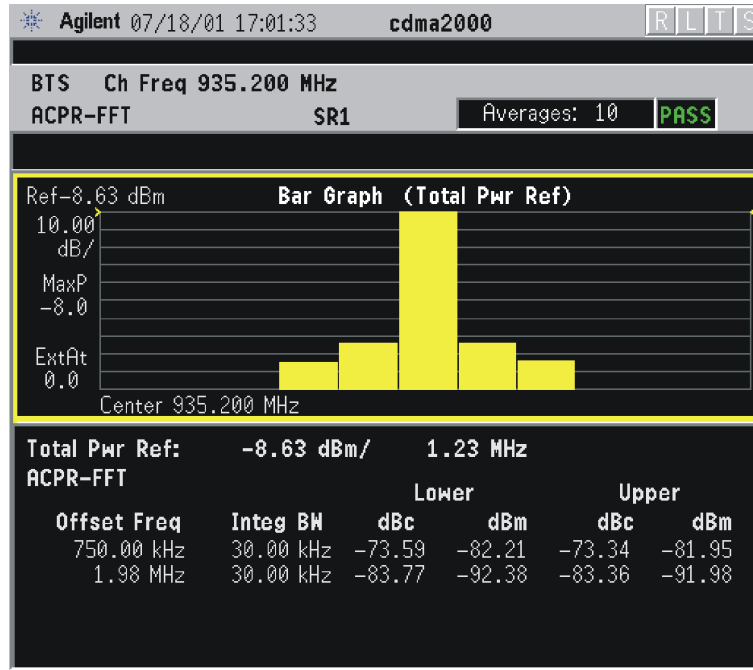

\*Meas Setup: Factory default settings

\*Input signal: -10.00 dBm, 9 channels of SR1, cdma2000 Rev 8

### Changing the Measurement Setup

The next table shows the factory default settings for adjacent channel power ratio measurements.

Table 4-3

Adjacent Channel Power Ratio Measurement Defaults

Measurement Parameter	Factory Default Condition
View/Trace	Bar Graph (Total Pwr Ref)
Avg Number	10; On
Avg Mode	Repeat
Chan Integ BW	1.23000 MHz

Table 4-3

Adjacent Channel Power Ratio Measurement Defaults

Measurement Parameter	Factory Default Condition
Ofs & Limits: Offset Offset Freq  Ref BW Abs Limit Fail Rel Lim (Car) Rel Lim (PSD)	A A: 765.000 kHz; On B: 1.99500 MHz; On C: 0.0 Hz; Off D: 0.0 Hz; Off E: 0.0 Hz; Off A to E: 30.000 kHz A to E: 50.00 dBm A to E: Relative A to E: 0.00 dBc A to E: 0.00 dB
Meas Type	Total Pwr Ref
Sweep Type	FFT
Swp RBW (grayed out for FFT)	6.667 kHz; Auto
Swp Det (grayed out for FFT)	Avg
<b>Advanced</b>	
Swp Acq Time	1.250 ms (grayed out for FFT)

Make sure the **ACPR** measurement is selected under the **MEASURE** menu. The **Meas Setup** key accesses the menu which allows you to modify the average number and average mode for this measurement.

In addition, the following parameters for adjacent channel power ratio measurements can be modified:

- **Chan Integ BW** - Allows you to specify the channel integration bandwidth in which the channel power levels are measured. The range is 300.0 Hz to 20.0000 MHz with 1 Hz resolution.
- **Ofs & Limits** - Allows you to access the menu to change the following parameters for offset frequency settings and pass/fail tests:
  - **Offset** - Allows you to access the memory selection menu from **A** to **E** to store 5 sets of values for **Offset Freq**, **Ref BW**, **Abs Limit** and so forth. Only one selection at a time (A, B, C, D, or E) is shown on this key.
  - **Offset Freq**- Allows you to enter an offset frequency center value, and to toggle the offset function between **On** and **Off**, according to each offset key selected. The range is 0.0 Hz to 100.000 MHz. While this key is activated, enter an offset frequency center value from the numeric keypad by terminating with one of the frequency unit keys shown. One offset frequency center value corresponding to the **Offset** menu selection is shown on this key,

however, this is titled as *Offset to Edge* in the measurement result window considering the measurement bandwidth.

The following figure illustrates the difference between the offset frequency center and the offset to edge frequency.

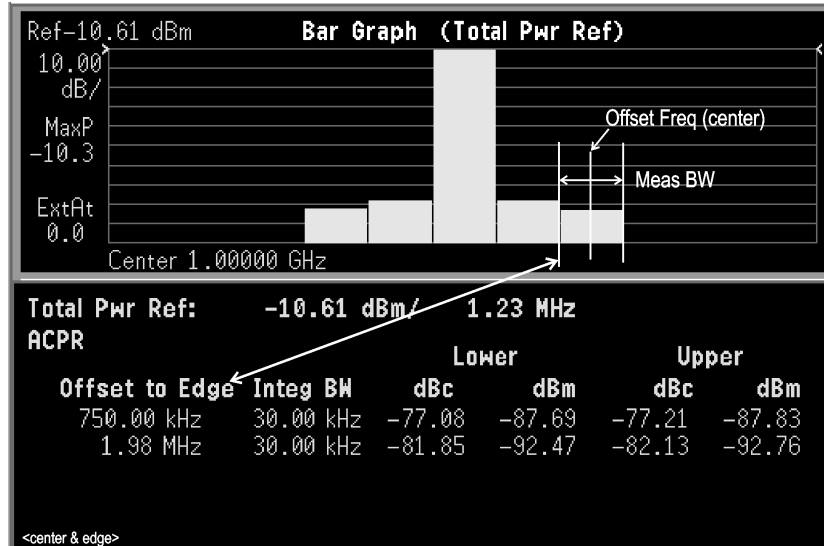

- **Ref BW** - Allows you to enter a reference bandwidth ranging from 300.0 Hz to 20.0000 MHz with 1 Hz resolution. When this parameter is changed, the integration bandwidth *Integ BW* in the summary data window changes to that value.
- **Abs Limit** - Allows you to enter an absolute limit value ranging from -200.00 to +50.00 dBm with 0.01 dB resolution.
- **Fail** - Allows you to access the following menu to select one of the logic keys for fail conditions between the measurement results and the test limits:
  - Absolute** - Fail is shown if one of the absolute ACPR measurement results is larger than the limit for **Abs Limit**.
  - Relative** - Fail is shown if one of the relative ACPR measurement results is larger than the limit for **Rel Lim (Car)** or **Rel Lim (PSD)**.
  - Abs AND Rel** - Fail is shown if one of the absolute ACPR measurement results is larger than the limit for **Abs Limit** AND one of the relative ACPR measurement results is larger than the limit for **Rel Lim (Car)** or **Rel Lim (PSD)**.
  - Abs OR Rel** - Fail is shown if one of the absolute ACPR measurement results is larger than the limit for **Abs Limit** OR one of the relative ACPR measurement results is larger than the limit for **Rel Lim (Car)** or **Rel Lim (PSD)**.
- **Rel Lim (Car)** - Allows you to enter a relative limit value of the carrier level ranging from -200.00 to +50.00 dBc with 0.01 dB

resolution.

- **Rel Lim (PSD)** - Allows you to enter a relative limit value of the power spectral density level ranging from  $-200.00$  to  $+50.00$  dB with 0.01 dB resolution.

Table 4-4

Default Offsets and Limits

Offset	Offset Frequency (kHz)		Abs Limit (dBm)	Rel Limit (Car) (dBc)	Rel Limit (PSD) (dB)
	BTS	MS		BTS/MS	BTS/MS
A, On	765.0	900.0	50.00	0.00	0.00
B, On	1995.0	1995.0	50.00	0.00	0.00
C, Off	0.000	0.000	50.00	0.00	0.00
D, Off	0.000	0.000	50.00	0.00	0.00
E, Off	0.000	0.000	50.00	0.00	0.00

- **Meas Type** - Allows you to access the menu to select one of the measurement reference types.
  - **Total Pwr Ref** - Select this to set the total carrier power to the measurement reference level and the measured data is shown in dBc and dBm.
  - **PSD Ref** - Select this to set the mean power spectral density of the carrier to the measurement reference level and the measured data is shown in dB and dBm/Hz.
- **Sweep Type** - Allows you to toggle the sweep function between **FFT** and **Swp** (swept). If set to **FFT**, data acquisition is made with the narrow channel integration bandwidth and apply Fast Fourier Transform to convert to the frequency domain data. If set to **Swp**, the measurement is made by the swept spectrum method like the traditional swept frequency spectrum analysis to have better correlation to the input signal with a high crest factor (peak/average ratio). However, it may take a longer time. Also, only the **Spectrum** view is available.
- **Swp RBW** - Allows you to enter the sweep resolution bandwidth, and to toggle this function between **Auto** and **Man** (manual), when **Sweep Type** is set to **Swp**, otherwise this key is grayed out. If set to **Auto**, this is automatically set to a value according to the sweep span derived from **Offset Freq** and **Ref BW**. If set to **Man**, this is manually changed. The range is 1.000 kHz to 1.00000 MHz with 1 Hz resolution.
- **Swp Det** - Allows you to toggle the sweep detector type between **Avg** (average) and **Peak**, when **Sweep Type** is set to **Swp**, otherwise this key is grayed out.

- **Advanced** - Allows you to access the menu to set the following parameters:
  - Swp Acq Time - Allows you to set the data acquisition time when Sweep Type is set to Swp. The range is 500.0  $\mu$ s to 10.00 ms with 1  $\mu$ s resolution.

## Changing the View

The **View/Trace** key accesses the menu to select either **Bar Graph** or **Spectrum** for the measurement result, depending on the **Sweep Type** setting.

- **Bar Graph** - In the factory default condition 5 of the total integration power levels, centered at the carrier frequency and  $\pm 765.0$  kHz and  $\pm 1.995$  MHz offset frequencies, are shown in the figure for the “Results” section. The corresponding measured data is shown in the text window. Depending on the **Meas Type** selection, one of the two following displays is obtained:

Bar Graph (Total Pwr Ref) - A histogram of powers referenced to the total power

Bar Graph (PSD Ref) - A histogram of powers referenced to the mean power spectral density of the carrier in dBm/Hz

- **Spectrum** - In the factory default condition, the frequency spectrum with the FFT sweep type is displayed with the bandwidth marker lines in the graph window. The corresponding measured data in the text window is the total integration power levels, in dBc and dBm, within the defined bandwidth as shown in the figure below.

**Figure 4-3 ACPR Measurement - FFT Spectrum (Total Pwr Ref) View**

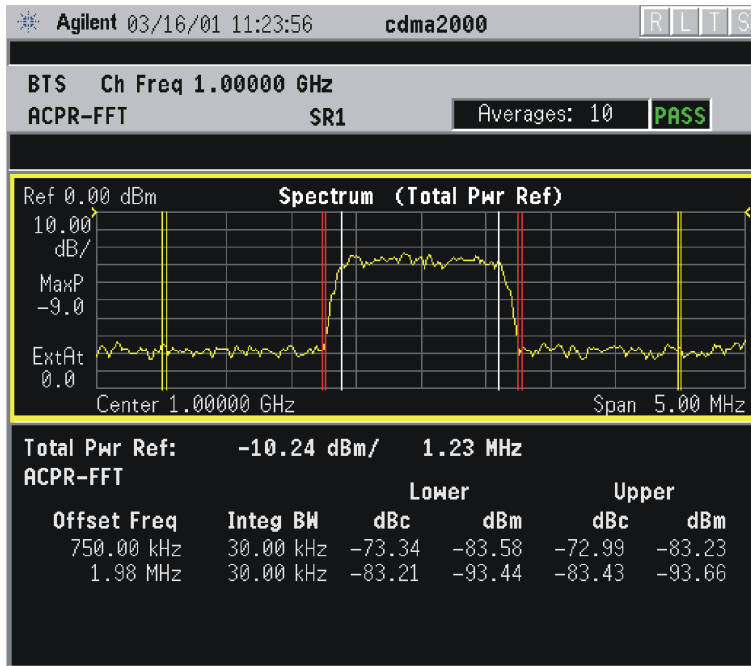

\*Meas Setup: View/Trace = Spectrum,  
 Others = Factory default settings

\*Input signal: -10.00 dBm, 9 channels of SR1, cdma2000 Rev 8

Depending on the **Meas Type** setting, one of the two following displays is obtained:

Spectrum (Total Pwr Ref) - A spectrum display referenced to the total power

Spectrum (PSD Ref) - A spectrum display referenced to the mean power spectral density of the carrier in dBm/Hz

**Figure 4-4** If Sweep Type is set to Swp, the swept frequency ACPR is displayed as shown below and only Spectrum is available for View/Trace.

**Figure 4-5 ACPR Measurement - Swept Spectrum (Total Pwr Ref) View**

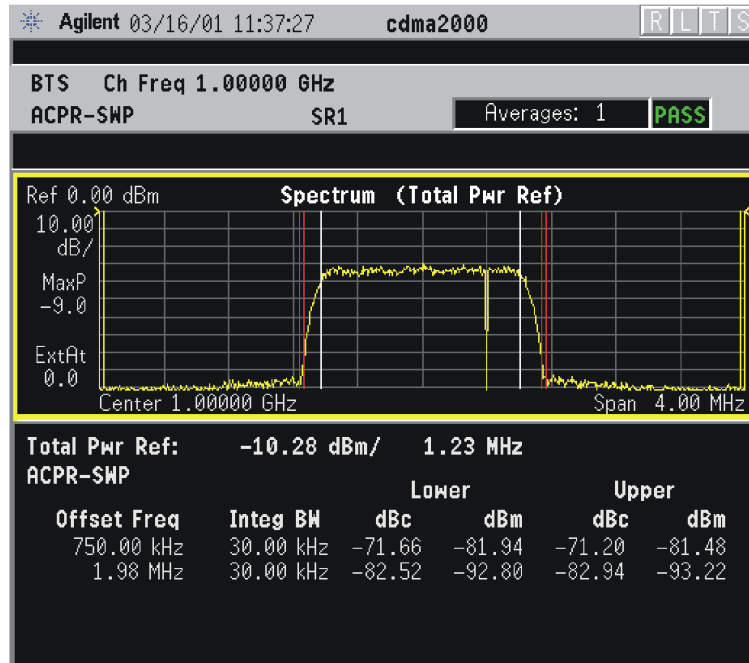

\*Meas Setup: View/Trace = Spectrum,  
 Sweep Type = Swp,  
 Others = Factory default settings

\*Input signal: -10.00 dBm, 9 channels of SR1, cdma2000 Rev 8

**NOTE**

If **Sweep Type** is set to **FFT**, the spectrum graph does not show the actual power level measured at each of the offsets. Select **Swp** for the more accurate spectrum graph.

While in this view, you can change the vertical scale by pressing the **AMPLITUDE Y Scale** key. You can also activate or deactivate the reference bandwidth markers by pressing the **Display** key.

**Changing the Display**

If **View/Trace** is set to **Spectrum**, the **AMPLITUDE Y Scale** key accesses the menu to set the desired measurement scale and associated parameters:

- **Scale/Div** - Allows you to enter a numeric value to change the vertical display sensitivity. The range is 0.10 to 20.00 dB with 0.01 dB resolution. The default setting is 10.00 dB. However, since the **Scale Coupling** is defaulted to **On**, this value is automatically determined by the measurement result. When you set a value manually, **Scale Coupling** automatically changes to **Off**.
- **Ref Value** - Allows you to set the absolute power reference value ranging from -250.00 to 250.00 dBm with 0.01 dB resolution. The default setting is 10.00 dBm. However, since the **Scale Coupling** is

Making Measurements

defaulted to **On**, this value is automatically determined by the measurement result. When you set a value manually, **Scale Coupling** automatically changes to **Off**.

- **Ref Position** - Allows you to set the reference position to either **Top**, **Ctr** (center), or **Bot** (bottom). The default setting is **Top**.
- **Scale Coupling** - Allows you to toggle the scale coupling function between **On** and **Off**. The default setting is **On**. Upon pressing the **Restart** front-panel key or **Restart** softkey under the **Meas Control** menu, this function automatically determines the scale per division and reference values based on the measurement results. When you set a value to either **Scale/Div** or **Ref Value** manually, **Scale Coupling** automatically changes to **Off**.

If **View/Trace** is set to **Spectrum**, the **Display** key also accesses the menu to control the line markers as follows:

- **Ref BW Marker** - Allows you to toggle the reference bandwidth markers function between **On** and **Off**. If set to **On**, the vertical line markers with the reference bandwidth are shown on the measurement result display.

## Using the Marker

The **Marker** key is not available for this measurement function.

## Troubleshooting Hints

This adjacent channel power ratio measurement can reveal degraded or defective parts in the transmitter section of the UUT. The following examples are those areas to be checked further.

- Some faults in the DC power supply control of the transmitter power amplifier, RF power controller of the pre-power amplifier stage, or I/Q control of the baseband stage
- Some degradation in the gain and output power level of the amplifier due to the degraded gain control and/or increased distortion
- Some degradation of the amplifier linearity and other performance characteristics

Power amplifiers are one of the final stage elements of a base or mobile transmitter and are a critical part of meeting the important power and spectral efficiency specifications. Since ACP measures the spectral response of the amplifier to a complex wideband signal, it is a key measurement linking amplifier linearity and other performance characteristics to the stringent system specifications.



---

## Making the Intermodulation Measurement

### Purpose

The cdma2000 standard defines transmit intermodulation as a measure of transmitter quality. Intermodulation products are generated by non-linear components or devices in equipment where two signals, one desired and another undesired, are present. Transmit intermodulation is a measure of a transmitter's ability to inhibit the generation of the intermodulation products.

### Measurement Method

The intermodulation measurement measures the third-order and fifth-order intermodulation products caused by the wanted signal and the interfering signal. These intermodulation products are generated by the nonlinear devices or circuits in a transmitter. The measured results are evaluated as a ratio, relative to the carrier power. There are two types of intermodulation:

- Two-tone - Measurements are made assuming two CW signals to be the tone signals.
- Transmit IM - Measurements are made assuming that one signal is the modulated transmitting signal and another is the CW signal.

This measurement automatically identifies either two-tone intermodulation mode or transmit intermodulation mode at the start of measurements. The fundamental signals, lower and upper, are automatically searched every sweep to calculate the proper results. When a measurement starts, the highest two peaks at frequency  $f_0$  and  $f_1$  are searched within a given span. Based on these frequencies, the frequencies associated with the possible third-order and fifth-order intermodulation products are calculated. The power bandwidth is checked to determine if the mode is two-tone intermodulation or transmit intermodulation.

The results are displayed both as relative power in dBc, and as absolute power in dBm. For transmit intermodulation products, the result is also shown as the power spectral density in dBm/MHz.

### Making the Measurement

The default settings provide a cdma2000 compliant measurement. For special requirements, you may need to change some of the settings. Press **Meas Setup**, **More**, **Restore Meas Defaults** at any time to return all parameters for the current measurement to the factory default settings.

Select the desired center frequency as described in [“Changing the](#)

Frequency Channel” on page 83.

Press **MEASURE**, **Intermod** (Intermodulation) to immediately make an intermodulation measurement.

To change any of the measurement parameters from the factory default values, refer to “Changing the Measurement Setup” on page 137.

## Results

The following figure shows an example result of Intermodulation measurements in the graph window. The absolute power levels, relative power levels, and power spectral density levels on both sides of the reference signal are displayed in the text window.

Figure 4-6

### Intermodulation Measurement - 2-tone Mode View

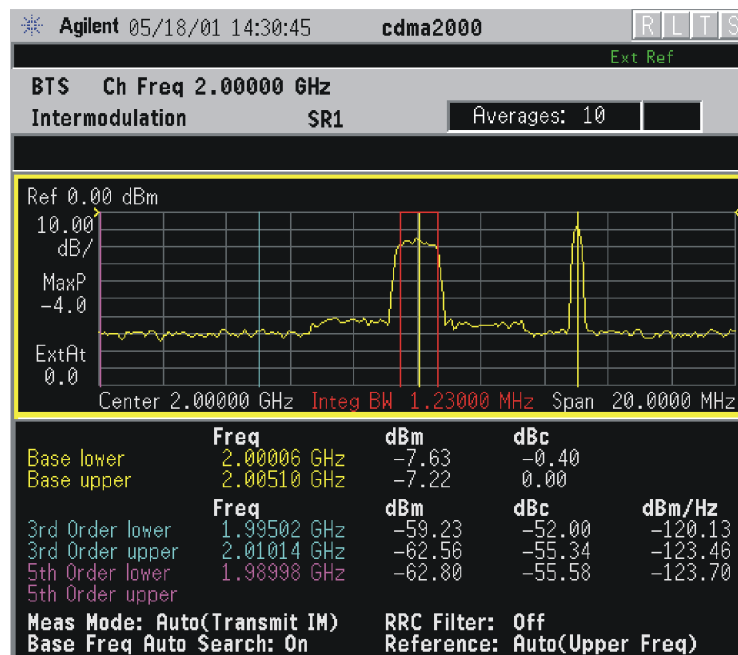

\*Meas Setup: Factory default settings

\*Input signal: (1) -10.00 dBm, 2.000 GHz, 9 channels of SR1, cdma2000 Rev 8  
 (2) -10.00 dBm, 2.005 GHz carrier signal

## Changing the Measurement Setup

This table shows the factory default settings for intermodulation measurements.

**Table 4-5 Intermodulation Measurement Defaults**

Measurement Parameter	Factory Default Condition
Display: IM Prod Ref	On
Meas Setup:	
Avg Number	10; On
Avg Mode	Repeat
Meas Mode	Two-tone, Transmit IM, or -----; Auto
Reference	Lower Freq or Upper Freq; Auto
Span	20.0000 MHz
Res BW	140.000 kHz; Auto
Base Freq Auto Search	On
Base Freq	(not available as Base Freq Auto Search is set to On)
<b>Advanced</b>	
RRC Filter	Off
Integ BW	1.23000 MHz

Make sure the **Intermod** measurement is selected under the **MEASURE** menu. The **Meas Setup** key accesses the menu which allows you to modify the average number and average mode for this measurement as described in “[Measurement Setup](#)” on page 127.

In addition, the following parameters for intermodulation products measurements can be modified.

- **Meas Mode** - Allows you to specify one of the following measurement modes:
  - **Auto** - Automatically identifies whether the intermodulation is caused by the two-tone or transmit intermodulation signals and that mode is labeled in the middle line of the **Meas Mode** key. If appropriate signals are not identified, “-----” is shown instead.
  - **Two-tone** - Measures the two-tone intermodulation products.
  - **Transmit IM** - Measures the transmit intermodulation products.

- **Reference** - Allows you to access the selection menu for the reference channel:
  - **Auto** - Select this to set the reference channel automatically to the highest level signal in two base frequency signals.
  - **Lower Freq** - Select this to set the reference channel to the base lower frequency signal.
  - **Upper Freq** - Select this to set the reference channel to the base upper frequency signal.
  - **Average** - Select this to set the reference channel to the average frequency signals, (base lower frequency signal + base upper frequency signal)/2.
- **Span** - Allows you to specify the frequency span in which intermodulation products are measured. The range is 100.000 kHz to 100.000 MHz with 1 Hz resolution.
- **Res BW** - Allows you to specify the resolution bandwidth in which intermodulation products are measured, and to toggle this function between **Auto** and **Man**. If set to **Auto**, the resolution bandwidth is automatically set according to the frequency span. The range is 100.0 Hz to 300.000 kHz with 1 Hz resolution.
- **Base Freq Auto Search** - Allows you to toggle the base frequency auto search function between **On** and **Off**. If set to **On**, the base frequency is automatically searched for.
- **Base Freq** - Allows you to specify the base frequency values with the followings items if **Base Freq Auto Search** is set to **Off**:
  - **Lower Freq (f0)** - Accepts a frequency value for the base lower frequency signal (f0).
  - **Upper Freq (f1)** - Accepts a frequency value for the base upper frequency signal (f1).
  - **Delta Freq (f1-f0)** - Automatically shows the difference between the base lower and base upper frequencies.
- **Advanced** - Allows you to access the menu to set the following items:
  - **RRC Filter** - Allows you toggles the root-raised cosine filter between **On** and **Off**.
  - **Integ BW** - Allows you to specify the integration bandwidth ranging from 100.0 kHz to 5.000 MHz.

## Changing the View

The **View/Trace** key is not available for this measurement.

## Changing the Display

When the **Spectrum** graph window is selected, the **AMPLITUDE Y Scale** key accesses the menu to set the desired measurement scale and associated parameters:

- **Scale/Div** - Allows you to enter a numeric value to change the vertical display sensitivity. The range is 0.10 to 20.00 dB with 0.01 dB resolution. The default setting is 10.00 dB. However, since the **Scale Coupling** default is **On**, this value is automatically determined by the measurement result. When you set a value manually, **Scale Coupling** automatically changes to **Off**.
- **Ref Value** - Allows you to set the absolute power reference value ranging from -250.00 to 250.00 dBm with 0.01 dB resolution. The default setting is 10.00 dBm. However, since the **Scale Coupling** default is **On**, this value is automatically determined by the measurement result. When you set a value manually, **Scale Coupling** automatically changes to **Off**.
- **Ref Position** - Allows you to set the reference position to either **Top**, **Ctr** (center), or **Bot** (bottom). The default setting is **Top**.
- **Scale Coupling** - Allows you to toggle the scale coupling function between **On** and **Off**. The default setting is **On**. Upon pressing the **Restart** front-panel key or **Restart** softkey under the **Meas Control** menu, the scale coupling function automatically determines the scale per division and reference values based on the measurement results. When you set a value to either **Scale/Div** or **Ref Value** manually, **Scale Coupling** automatically changes to **Off**.

The **Display** key also accesses the menu to control the markers on the display as follows:

- **IM Prod Ref** - Allows you to toggle the intermodulation product lines display function between **On** and **Off**. If set to **On**, two pairs of dual vertical lines with the integration bandwidth are shown on the third-order or fifth-order intermodulation products display.

## Using the Markers

The **Marker** front-panel key accesses the menu to configure the markers.

- **Select 1 2 3 4** - Allows you to activate up to four markers with the corresponding numbers, respectively. The selected number is underlined and its function is defined by pressing the **Function** key. The default is 1.
- **Normal** - Allows you to activate the selected marker to read the time position and amplitude of the marker on the Signal envelope trace, for example. Marker position is controlled by the **RPG** knob.
- **Delta** - Allows you to read the differences in time positions and

amplitudes between the selected marker and the next.

- **Function** - Allows you to define the selected marker function to be **Band Power**, **Noise**, or **Off**. The default is **Off**. For measuring **Band Power**, you need to place the **Normal** marker and then place the **Delta** marker.
- **Trace** - Allows you to place the selected marker on the **Spectrum** trace.
- **Off** - Allows you to turn off the selected marker.
- **Shape Diamond** - Allows you to access the menu to define the selected marker shape to be **Diamond**, **Line**, **Square**, or **Cross**. The default is **Diamond**.
- **Marker All Off** - Allows you to turn off all of the markers.

The front-panel **Search** key performs a peak search when pressed. A marker will automatically be activated at the highest peak.

## Troubleshooting Hints

Intermodulation distortion (IMD) measurements can reveal the presence of degraded or defective parts in the transmitter section of the UUT. The following are examples of problems which, once indicated by IMD testing, may require further attention:

- Faulty DC power supply control of the transmitter power amplifier.
- RF power controller of the pre-power amplifier stage.
- I/Q control of the baseband stage.
- Reduction in the gain and output power level of the amplifier due to a degraded gain control and/or increased distortion.
- Degradation of amplifier linearity and other performance characteristics.

Power amplifiers are one of the final stage elements of a base or mobile transmitter and play a critical part in meeting the important power and spectral efficiency specifications. Measuring the spectral response of these amplifiers to complex wideband signals is crucial to linking amplifier linearity and other performance characteristics to the stringent system specifications.

---

## Making the Spectrum Emission Mask Measurement

### Purpose

Spectrum Emission Mask measurements include the in-band and out-of-band spurious emissions. As it applies to cdma2000, it is the power contained in a specified frequency bandwidth at certain offsets relative to the total carrier power. It may also be expressed as a ratio of power spectral densities between the carrier and the specified offset frequency band.

As a composite measurement of out-of-channel emissions, the spectrum emission mask measurement combines both in-band and out-of-band specifications to provide useful figures-of-merit for spectral regrowth and emissions produced by components and circuit blocks without the rigor of performing a full spectrum emissions mask measurement.

### Measurement Method

The spectrum emission mask measurement measures spurious signal levels in up to five pairs of offset/region frequencies and relates them to the carrier power. The reference channel integration bandwidth method is used to measure the carrier channel power and offset/region powers. When “Offset” is selected, spectrum emission mask measurements are made, relative to the carrier channel frequency bandwidth. When “Region” is selected, spurious emission absolute measurements are made, set by specifying start and stop RF frequencies. The upper frequency range limit is 3.678 GHz. The measurement screen is titled Spurious Emission.

This integration bandwidth method performs a time domain data acquisition. In this process, the reference channel integration bandwidth (Meas BW) is analyzed using the automatically defined resolution bandwidth (Res BW), which is much narrower than the channel bandwidth. The measurement computes an average power of the channel or offset/region over a specified number of data acquisitions, automatically compensating for resolution bandwidth and noise bandwidth.

This measurement requires the user to specify measurement bandwidths of the carrier channel and each of the offset/region frequency pairs up to 5. Each pair may be defined with unique measurement bandwidths. The results are displayed both as relative power in dBc, and as absolute power in dBm. Refer to [Table 4-7 on page 157](#) through [Table 4-10 on page 160](#) for the default values of offset and region frequencies, resolution bandwidths, and limits.

## Making the Measurement

**NOTE** The factory default settings provide a cdma2000 compliant measurement. For special requirements, you may need to change some of the settings. Press **Meas Setup, More, Restore Meas Defaults** at any time to return all parameters for the current measurement to their default settings.

Select the desired center frequency as described in “[Changing the Frequency Channel](#)” on page 83.

Press **MEASURE, Spectrum Emission Mask** to immediately make a spectrum emission mask measurement.

To change any of the measurement parameters from the factory default values, refer to “[Changing the Measurement Setup](#)” on page 137.

## Results

The following figure shows an example of a Spectrum (Ref: Total Pwr, Seg: Offset) measurement result in the graph window. The absolute peak power levels and those corresponding frequencies on both sides of the reference channel are displayed in the text window.

**Figure 4-7** Spectrum Emission Mask Measurement - Offset Segment View

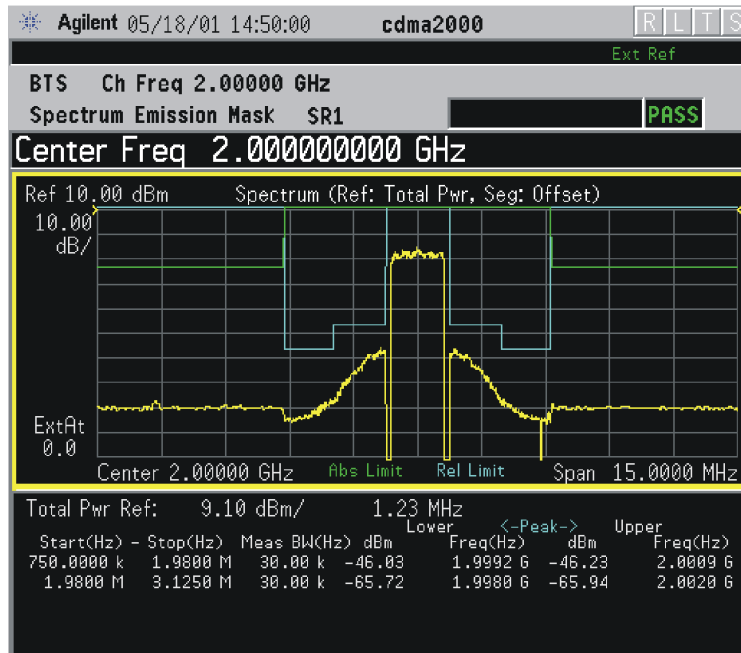

\*Meas Setup: Factory default settings

\*Input signal: 10.00 dBm, 9 channels of SR1, cdma2000 Rev 8



## Changing the Measurement Setup

This table shows the factory default settings for spectrum emission mask measurements.

**Table 4-6 Spectrum Emission Mask Measurement Defaults**

Measurement Parameter	Factory Default Condition
View/Trace	All
Offset	Pos
Display	Abs Peak Pwr & Freq
Limit Lines	On
Meas Setup:	
Avg Number	10; Off
Meas Interval	1.000 ms
Ref Channel:	
Chan Integ BW	1.23000 MHz
Chan Span	1.25000 MHz
Step Freq	12.300 kHz; Auto
Res BW	24.600 kHz; Auto
Spectrum Segment	Offset
Offset/Limits:	(Refer to <a href="#">Table 4-7 on page 157</a> )
Offset	A
Start Freq	765.000 kHz
Stop Freq	795.000 MHz
Step Freq	15.000 kHz; Auto
Res BW	3.000 kHz; Man
Meas BW (Integ BW)	30.000 kHz; 10 × Res BW
Relative Atten	0.00 dB
Offset Side	Both
Limits:	
Abs Start	-27.00 dBm
Abs Stop	-27.00 dBm; Couple
Rel Start	-45.00 dBc
Rel Stop	-45.00 dBc; Couple

**Table 4-6 Spectrum Emission Mask Measurement Defaults**

Measurement Parameter	Factory Default Condition
Fail Mask	Relative
Detector	Avg
Meas Type	Total Pwr Ref
Trig Source	Free Run (Immediate)

Make sure the **Spectrum Emission Mask** measurement is selected under the **MEASURE** menu. The **Meas Setup** key accesses the menus which allow you to modify the average number, average mode, and trigger source for this measurement as described in “[Measurement Setup](#)” on [page 127](#).

In addition, the following parameters for spectrum emission mask measurements can be modified.

- **Meas Interval** - Allows you to specify the measurement interval ranging from 0.1 to 10.0 ms with 0.001 ms resolution.
- **Ref Channel** - Allows you to define the reference channel in the following terms:
  - **Chan Integ BW** - Allows you to specify the channel integration bandwidth ranging from 100.0 kHz to the setting of **Chan Span**.
  - **Chan Span** - Allows you to specify the channel span to be measured ranging from 100.000 kHz to 10.0000 MHz.
  - **Step Freq** - Allows you to specify the step frequency to make measurements ranging from 100.0 Hz to 7.50000 MHz, and to toggle this function between **Auto** and **Man**. If set to **Auto**, this is automatically set to half the **Res BW** setting. If set to **Man**, the step frequency is manually set independently from **Res BW**.
  - **Res BW** - Allows you to specify the resolution bandwidth ranging from 1.000 kHz to 7.50000 MHz, and to toggle this function between **Auto** and **Man**. If set to **Auto**, **Res BW** is automatically set to one 50th of **Chan Integ BW**. The next figure illustrates the relationship between **Meas BW**, **Start Freq**, and **Stop Freq**.

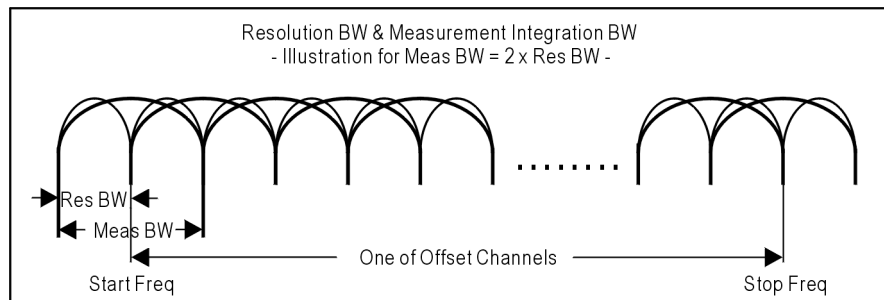

- **Meas BW** - Allows you to specify a multiplier of **Res BW** for the measurement integration bandwidth, ranging from 1 to an integer derived from  $(\text{Start Freq} - \text{Stop Freq})/\text{Res BW}$ . Refer to the illustration under **Res BW** above.
- **Spectrum Segment** - Allows you to toggle the frequency spectrum segment between **Offset** and **Region**. Upon selecting **Offset**, spectrum emission mask measurements are made. Upon selecting **Region**, spurious emission measurements are made. Depending on this selection, either the **Offset/Limits** menu or the **Region/Limits** menu is available.
- **Offset/Limits** - Allows you to access the menus to change the following parameters for offset frequency settings and pass/fail tests, if **Spectrum Segment** is set to **Offset**. [Table 4-7 on page 157](#) and [Table 4-8 on page 158](#) show the default settings for BTS and MS measurements, respectively.

When **Spectrum Segment** is set to **Offset**, the frequency values at Start (Hz) and Stop (Hz) are shown as Offset to Edge in the measurement result window considering the measurement bandwidth, as it is different from the offset frequency center as shown in the following illustration.

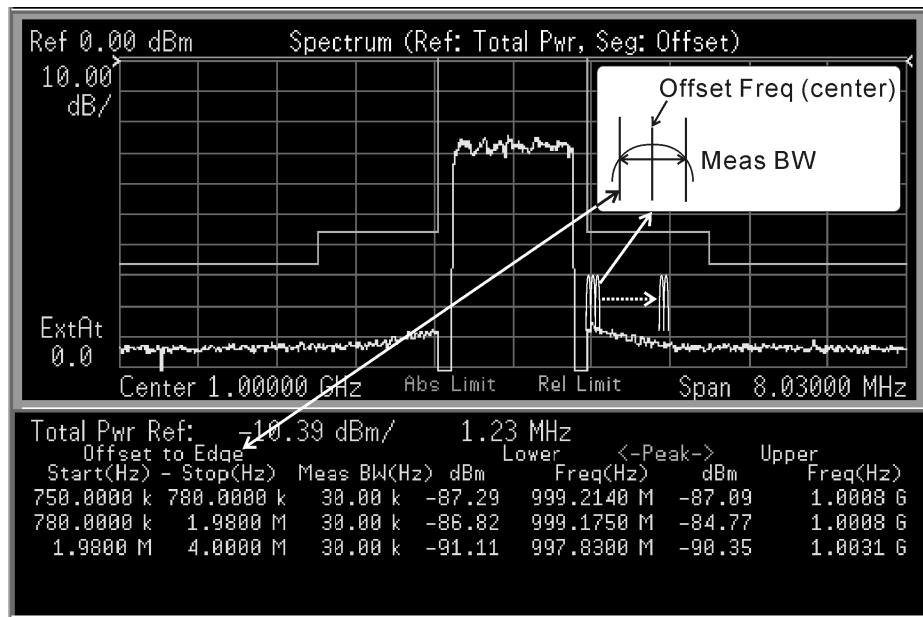

- **Offset** - Allows you to access the memory selection menu from **A** to **E** to store up to 5 sets of values for **Start Freq**, **Stop Freq**, **Step Freq**, **Res BW**, and **Limits**. Only one memory selection at a time (A, B, C, D, or E) is shown on this key label.
- **Start Freq** - Allows you to specify the start frequency, and to toggle this function between **On** and **Off**, for each offset. The frequency range is 10.0000 kHz to 100.000 MHz with 100 Hz resolution. However, the high end is limited to the setting of **Stop Freq**. When

**Spectrum Segment** is set to **Offset**, the frequency values at **Start** (Hz) are shown as **Offset to Edge** in the measurement result window considering the measurement bandwidth.

- **Stop Freq** - Allows you to specify the stop frequency ranging from 10.0000 kHz to 100.000 MHz with 100 Hz resolution, for each offset. The low end is limited to the setting of **Start Freq**. When **Spectrum Segment** is set to **Offset**, the frequency values at **Stop** (Hz) are shown as **Offset to Edge** in the measurement result window considering the measurement bandwidth.
- **Step Freq** - Allows you to specify the step frequency ranging from  $(\text{Stop Freq} - \text{Start Freq})/10000$  to  $(\text{Stop Freq} - \text{Start Freq})$ , and to toggle this function between **Auto** and **Man**, for each offset. If set to **Auto**, the step frequency is automatically set to half the **Res BW** setting.
- **Res BW** - Allows you to specify the resolution bandwidth ranging from 300.0 Hz to 7.50000 MHz with 100 Hz resolution, and to toggle this function between **Auto** and **Man**, for each offset. If set to **Auto**, the resolution bandwidth is automatically set to one 50th of  $(\text{Stop Freq} - \text{Start Freq})$ .
- **Meas BW** - Allows you to specify a multiplier of **Res BW** for the measurement integration bandwidth ranging from 1 to  $(\text{Stop Freq} - \text{Start Freq})/\text{Res BW}$ .
- **Relative Atten** - Allows you to enter an attenuation value to adjust the relative level limits ranging from -40.00 to 40.00 dB with 0.01 dB resolution. The default attenuation is the same as the one used by **Ref Channel**.
- **Offset Side** - Allows you to specify which offset side is to be measured. Selections are **Neg** (negative offset), **Both**, and **Pos** (positive offset).
- **Limits** - Allows you to access the following menu to set up absolute and relative limit levels and fail conditions for each offset:
  - Abs Start** - Allows you to enter an absolute level limit at **Start Freq** ranging from -200.00 to +50.00 dBm with 0.01 dB resolution.
  - Abs Stop** - Allows you to enter an absolute level limit at **Stop Freq** ranging from -200.00 to +50.00 dBm with 0.01 dB resolution, and to toggle this function between **Couple** and **Man**. If set to **Couple**, **Abs Stop** is coupled to **Abs Start** to make a flat limit line. If set to **Man**, **Abs Start** and **Abs Stop** can take different values to make a sloped limit line.
  - Rel Start** - Allows you to enter a relative level limit at **Start Freq** ranging from -150.00 to +50.00 dBc with 0.01 dB resolution.
  - Rel Stop** - Allows you to enter a relative level limit at **Stop Freq**

ranging from  $-150.00$  to  $+50.00$  dBc with 0.01 dB resolution, and to toggle this function between **Couple** and **Man**. If set to **Couple**, **Rel Stop** is coupled to **Rel Start** to make a flat limit line. If set to **Man**, **Rel Start** and **Rel Stop** can take different values to make a sloped limit line.

- ❑ **Fail Mask**- Allows you to access the following menu to select one of the logic keys for fail conditions between the measurement results and the test limits:

**Absolute** - Fail is shown if one of the absolute spectrum emission mask measurement results is larger than the limit for **Abs Start** and/or **Abs Stop**. This is the default selection for offsets **B** and **C**.

**Relative** - Fail is shown if one of the relative spectrum emission mask measurement results is larger than the limit for **Rel Start** and/or **Rel Stop**. This is the default selection for offset **A**.

**Abs AND Rel** - Fail is shown if one of the absolute spectrum emission mask measurement results is larger than the limit for **Abs Start** and **Abs Stop** AND one of the relative spectrum emission mask measurement results is larger than the limit for **Rel Start** and **Rel Stop**.

**Abs OR Rel** - Fail is shown if one of the absolute spectrum emission mask measurement results is larger than the limit for **Abs Start** and **Abs Stop** OR one of the relative spectrum emission mask measurement results is larger than the limit for **Rel Start** and **Rel Stop**.

**Table 4-7 Offsets & Limits - BTS Measurement Defaults**

Offset	Start Freq (MHz)	Stop Freq (MHz)	Step Freq (kHz)	Meas BW (kHz)	Abs Start (dBm)	Abs Stop (dBm)	Rel Start (dBc)	Rel Stop (dBc)	Fail Mask
A, On	0.7650	0.7950	1.500	30.00	-27.00	-27.00	-45.00	-45.00	Rel
B, On	0.7950	1.9950	15.00	30.00	-27.00	-27.00	-45.00	-45.00	Rel
C, On	1.9950	4.0150	15.00	30.00	-27.00	-27.00	-55.00	-55.00	Rel
D, Off	3.2531	4.0031	3.125	6.250	-46.00	-46.00	-55.00	-55.00	Abs
E, Off	7.5000	12.500	500.00	1000.0	-13.00	-13.00	-55.00	-55.00	Rel

Table 4-8 Offsets & Limits - MS Measurement Defaults

Offset	Start Freq (MHz)	Stop Freq (MHz)	Step Freq (kHz)	Meas BW (kHz)	Abs Start (dBm)	Abs Stop (dBm)	Rel Start (dBc)	Rel Stop (dBc)	Fail Mask
A, On	0.9000	1.9950	15.00	30.00	-70.13	-70.13	-42.00	-42.00	AND
B, On	1.9950	4.0150	15.00	30.00	-70.13	-70.13	-54.00	-54.00	AND
C, Off	2.2531	4.0150	3.125	6.250	-35.00	-35.00	-54.00	-54.00	Abs
D, Off	8.5000	12.000	500.00	1000.00	-13.00	-13.00	-54.00	-54.00	Rel
E, Off	12.500	15.000	500.00	1000.00	-13.00	-13.00	-54.00	-54.00	Rel

- **Region/Limits** - Allows you to access the menus to change the following parameters for region frequency settings and pass/fail tests, if **Spectrum Segment** is set to **Region**. [Table 4-9 on page 160](#) and [Table 4-10 on page 160](#) show the default setting for BTS and MS measurements, respectively.
  - **Region** - Allows you to access the memory selection menu from **A** to **E** to store up to 5 sets of values for **Start Freq**, **Stop Freq**, **Step Freq**, **Res BW**, and **Limits**. Only one memory selection at a time (**A**, **B**, **C**, **D**, or **E**) is shown on this key label. The default is **A**.
  - **Start Freq** - Allows you to specify the start frequency, and to toggle this function between **On** and **Off**, for each region. The frequency range is 329.000 MHz to 3.67800 GHz with 1 kHz resolution. However, the high end is limited to the setting of **Stop Freq**. The default settings are 1.92000 GHz and **On**.
  - **Stop Freq** - Allows you to specify the stop frequency ranging from 329.000 MHz to 3.67800 GHz with 1 kHz resolution, for each region. The low end is limited to the setting of **Start Freq**. The default setting is 1.98000 GHz.
  - **Step Freq** - Allows you to specify the step frequency ranging from  $(\text{Stop Freq} - \text{Start Freq})/10000$  to  $(\text{Stop Freq} - \text{Start Freq})$ , and to toggle this function between **Auto** and **Man**, for each region. If set to **Auto**, the step frequency is automatically set to half the **Res BW** setting. The default settings are 600.000 kHz and **Auto**.
  - **Res BW** - Allows you to specify the resolution bandwidth ranging from 1.000 kHz to 7.50000 MHz with 100 Hz resolution, and to toggle this function between **Auto** and **Man**, for each region. If set to **Auto**, **Res BW** is automatically set to one 50th of  $(\text{Stop Freq} - \text{Start Freq})$ .

**Freq**). The default settings are 1.20000 MHz and **Auto**.

- **Relative Atten** - Allows you to enter an attenuation value to adjust the relative level limits ranging from -40.00 to 40.00 dB with 0.01 dB resolution. The default attenuation is the same as the one used for **Ref Channel**.
- **Limits** - Allows you to access the following menu to set up absolute and relative limit levels and fail conditions for each region:
  - Abs Start** - Allows you to enter an absolute level limit at **Start Freq** ranging from -200.00 to +50.00 dBm with 0.01 dB resolution. The default setting is -50.00 dBm.
  - Abs Stop** - Allows you to enter an absolute level limit at **Stop Freq** ranging from -200.00 to +50.00 dBm with 0.01 dB resolution, and to toggle this function between **Couple** and **Man**. If set to **Couple**, **Abs Stop** is coupled to **Abs Start** to make a flat limit line. If set to **Man**, **Abs Start** and **Abs Stop** can take different values to make a sloped limit line. The default settings are -50.00 dBm and **Couple**.
  - Rel Start** - Allows you to enter a relative level limit ranging from -150.00 to +50.00 dBc with 0.01 dB resolution. The default settings are -30.00 dBm.
  - Rel Stop** - Allows you to enter a relative level limit at **Stop Freq** ranging from -150.00 to +50.00 dBc with 0.01 dB resolution, and to toggle this function between **Couple** and **Man**. If set to **Couple**, **Rel Stop** is coupled to **Rel Start** to make a flat limit line. If set to **Man**, **Rel Start** and **Rel Stop** can take different values to make a sloped limit line. The default settings are -30.00 dBm and **Couple**.
  - Fail Mask**- Allows you to access the following menu to select one of the logic keys for fail conditions between the measurement results and the test limits. The default selection is **Absolute**.

**Absolute** - Fail is shown if one of the absolute spurious emission mask measurement results is larger than the limit for **Abs Start** and/or **Abs Stop**. This is the default selection for each region.

**Relative** - Fail is shown if one of the relative spurious emission mask measurement results is larger than the limit for **Rel Start** and/or **Rel Stop**.

**Abs AND Rel** - Fail is shown if one of the absolute spurious emission mask measurement results is larger than the limit for **Abs Start** and **Abs Stop** AND one of the relative spurious emission mask measurement results is larger than the limit for **Rel Start** and **Rel Stop**.

**Abs OR Rel** - Fail is shown if one of the absolute spurious

emission mask measurement results is larger than the limit for **Abs Start** and **Abs Stop** OR one of the relative spurious emission mask measurement results is larger than the limit for **Rel Start** and **Rel Stop**.

**Table 4-9 Regions & Limits- BTS Measurement Defaults**

Region	Start Freq (MHz)	Stop Freq (MHz)	Step Freq (kHz)	Res BW (kHz)	Abs Start (dBm)	Abs Stop (dBm)	Rel Start (dBc)	Rel Stop (dBc)	Fail Mask
A, On	1920.0	1980.0	500.00	1000.0	-86.00	-86.00	-30.00	-30.00	Abs
B, On	1893.5	1919.6	150.00	300.00	-41.00	-41.00	-30.00	-30.00	Abs
C, Off	876.00	915.0	50.000	100.00	-98.00	-98.00	-30.00	-30.00	Abs
D, Off	921.00	960.0	50.000	100.00	-57.00	-57.00	-30.00	-30.00	Abs
E, Off	800.00	1000.0	2000.0	4000.0	-50.00	-50.00	-30.00	-30.00	Abs

**Table 4-10 Regions & Limits- MS Measurement Defaults**

Region	Start Freq (MHz)	Stop Freq (MHz)	Step Freq (kHz)	Res BW (kHz)	Abs Start (dBm)	Abs Stop (dBm)	Rel Start (dBc)	Rel Stop (dBc)	Fail Mask
A, On	1893.5	1919.6	150.00	300.00	-41.00	-41.00	-30.00	-30.00	Abs
B, On	925.00	935.0	50.00	100.00	-67.00	-67.00	-30.00	-30.00	Abs
C, On	935.00	960.0	50.00	100.00	-79.00	-79.00	-30.00	-30.00	Abs
D, Off	1805.0	1880.0	50.00	100.00	-71.00	-71.00	-30.00	-30.00	Abs
E, Off	800.0	1000.0	2000.0	4000.0	-50.00	-50.00	-30.00	-30.00	Abs

- **Detector** - Allows you to toggle the power detection type between **Avg** (average) and **Peak**. If set to **Avg**, the power in a bin is computed as RMS averaged over the entire **Meas Interval**. If set to **Peak**, the peak power in the entire **Meas Interval** is converted to the RMS value, assuming a CW signal.
- **Meas Type** - Allows you to access the menu to select one of the measurement reference types.
  - **Total Pwr Ref** - Sets the reference to the total carrier power and the measured data is shown in dBc and dBm.
  - **PSD Ref** - Sets the reference to the mean power spectral density of the carrier and the measured data is shown in dB and dBm/Hz.
- **Trig Source** - Allows you to select one of the trigger sources: **Free Run (Immediate)**, **Ext Front**, **Ext Rear**, **Frame**, or **Line**.



## Changing the View

The **View/Trace** key accesses the menu to select the desired view of the measurement result according to the selection of **Spectrum Segment**.

If **Spectrum Segment** is set to **Offset**, the following menu is shown:

- **All** - In the factory default condition, the spectrum emission mask measurement graph is displayed with all of the active offsets in the graph window as shown in [Figure 4-7 on page 152](#).
- **Offset A to Offset E** - Each spectrum emission mask measurement result, up to 5 sets of offsets, is shown in the graph window. Each offset label set to **Off** is grayed out.
- **Offset**- Allows you to toggle the display function of the offset sides between **Pos** (positive) and **Neg** (negative).

If **Spectrum Segment** is set to **Region**, the following menu is shown:

- **All** - The spurious emission measurement graph is displayed with all of the active regions in the graph window as shown below:

Figure 4-8

### Spurious Emission Measurement - All Regions View

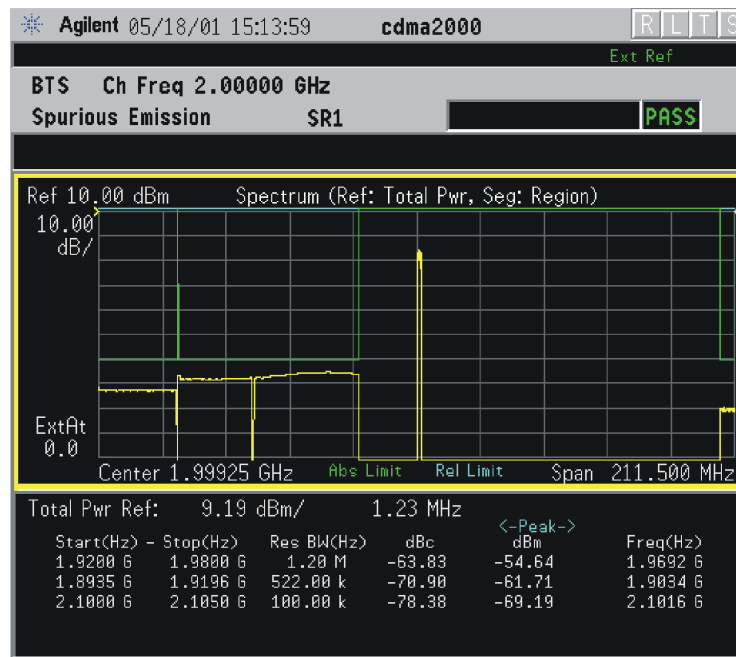

\*Meas Setup: Spectrum Segment = Region,  
View/Trace = All (default),  
Others = Factory default settings

\*Input signal: 10.00 dBm, 9 channels of SR1, cdma2000 Rev 8

- **Region A to Region E** - Each spurious emission measurement result, up to 5 sets of regions, is shown in the graph window. Each region label set to **Off** is grayed out.

## Changing the Display

The **AMPLITUDE Y Scale** key accesses the menu to allow the following settings for desired graph displays:

- **Scale/Div** - Allows you to enter a numeric value to change the vertical display sensitivity. The range is 0.10 to 20.00 dB with 0.01 dB resolution. The default setting is 10.00 dB. However, since the **Scale Coupling** default is **On**, this value is automatically determined by the measurement result. When you set a value manually, **Scale Coupling** automatically changes to **Off**.
- **Ref Value** - Allows you to set the absolute power reference value ranging from -250.00 to 250.00 dBm with 0.01 dB resolution. The default setting is 10.00 dBm. However, since the **Scale Coupling** default is **On**, this value is automatically determined by the measurement result. When you set a value manually, **Scale Coupling** automatically changes to **Off**.
- **Ref Position** - Allows you to set the reference position to either **Top**, **Ctr** (center), or **Bot** (bottom). The default setting is **Top**.
- **Scale Coupling** - Allows you to toggle the scale coupling function between **On** and **Off**. The default setting is **On**. Upon pressing the **Restart** front-panel key or the **Restart** softkey under the **Meas Control** menu, scale coupling automatically determines the scale per division and reference values based on the measurement results. When you set a value to either **Scale/Div** or **Ref Value** manually, **Scale Coupling** automatically changes to **Off**.

The **Display** key also accesses the menu to allow the following selections to control the screen display:

- **Limit Lines** - Allows you to toggle the limit lines display function for spectrum emission mask measurements between **On** and **Off**. If set to **On**, the absolute limit lines and the relative limit lines are shown on the spectrum emission mask measurement display.
- **Abs Peak Pwr & Freq** - Allows you to read the absolute peak power levels in dBm and corresponding frequencies in the text window. This key is disabled if **Spectrum Segment** is set to **Region**.
- **Rel Peak Pwr & Freq** - Allows you to read the relative peak power levels in dBc and corresponding frequencies in the text window. This key is disabled if **Spectrum Segment** is set to **Region**.
- **Integrated Power** - Allows you to read the absolute and relative power levels integrated throughout the bandwidths between the start and stop frequencies in the text window. This key is disabled if **Spectrum Segment** is set to **Region**.

## Using the Markers

The **Marker** front-panel key accesses the menu to configure the markers.

- **Select 1 2 3 4** - Allows you to activate up to four markers with the corresponding numbers, respectively. The selected number is underlined and its function is defined by pressing the **Function** key. The default is 1.
- **Normal** - Allows you to activate the selected marker to read the time position and amplitude of the marker on the Signal envelope trace, for example. Marker position is controlled by the **RPG** knob.
- **Delta** - Allows you to read the differences in time positions and amplitudes between the selected marker and the next.
- **Function** - Allows you to define the selected marker function to be **Band Power**, **Noise**, or **Off**. The default is **Off**. For measuring **Band Power**, you need to place the **Normal** marker and then place the **Delta** marker.
- **Trace** - Allows you to place the selected marker on the **Spectrum** trace.
- **Off** - Allows you to turn off the selected marker.
- **Shape Diamond** - Allows you to access the menu to define the selected marker shape to be **Diamond**, **Line**, **Square**, or **Cross**. The default is **Diamond**.
- **Marker All Off** - Allows you to turn off all of the markers.

The front-panel **Search** key performs a peak search when pressed. A marker will automatically be activated at the highest peak.

## Troubleshooting Hints

Spectrum Emission mask measurements can reveal the presence of degraded or defective parts in the transmitter section of the UUT. The following are examples of problems which, once indicated by testing, may require further attention:

- Faulty DC power supply control of the transmitter power amplifier.
- RF power controller of the pre-power amplifier stage.
- I/Q control of the baseband stage.
- Reduction in the gain and output power level of the amplifier due to a degraded gain control and/or increased distortion.
- Degradation of amplifier linearity and other performance characteristics.

Power amplifiers are one of the final stage elements of a base or mobile transmitter and play a critical part in meeting the important power and

spectral efficiency specifications. Measuring the spectral response of these amplifiers to complex wideband signals is crucial to linking amplifier linearity and other performance characteristics to the stringent system specifications.

---

## Making the Occupied Bandwidth Measurement

### Purpose

Occupied bandwidth measurements express the percentage of the transmitted power within a specified bandwidth. This percentage is typically 99%.

The spectrum shape of a cdma2000 signal can give useful qualitative insight into transmitter operation. Any distortion to the spectrum shape can indicate problems in transmitter performance.

### Measurement Method

The instrument uses digital signal processing (DSP) to sample the input signal and convert it to the frequency domain. With the instrument tuned to a fixed center frequency, samples are digitized at a high rate with DSP hardware, and then converted to the frequency domain with FFT software.

The total power within the measurement frequency span is integrated for its 100% of power. The frequencies of 0.5% of the total power are then calculated to get 99.0% bandwidth.

For E4406A Option B7C, this measurement is available for use with either the RF input or Baseband I/Q inputs. For detailed operation, see [“Using Option B7C Baseband I/Q Inputs” on page 238](#).

### Making the Measurement

---

#### NOTE

The factory default settings provide a cdma2000 compliant measurement. For special requirements, you may need to change some of the settings. Press **Meas Setup, More, Restore Meas Defaults** at any time to return all parameters for the current measurement to their default settings.

Select the desired center frequency as described in [“Changing the Frequency Channel” on page 83](#).

Press **MEASURE, Occupied BW** to immediately make an occupied bandwidth measurement.

To change any of the measurement parameters from the factory default values, refer to [“Changing the Measurement Setup” on page 137](#).

## Results

The next figure shows an example result of Occupied BW measurements. The occupied bandwidth graph is shown in the graph window. The occupied bandwidth for 99.00% of the total power and the total power level are shown in the text window.

Figure 4-9

### Occupied Bandwidth Measurement

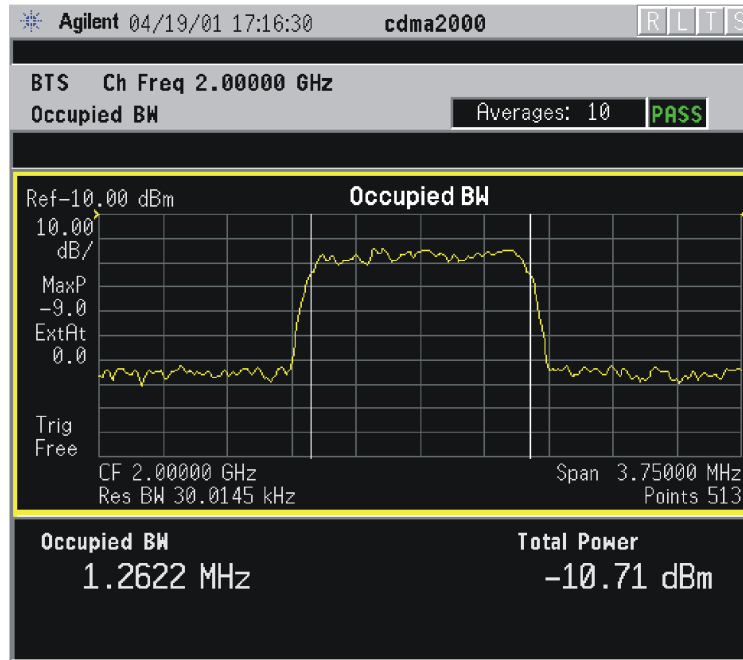

\*Meas Setup: Factory default settings

\*Input signal: -10.00 dBm, 9 channels of SR1, cdma2000 Rev 8

## Changing the Measurement Setup

The next table shows the factory default settings for occupied bandwidth measurements.

**Table 4-11** Occupied Bandwidth Measurement Defaults

Measurement Parameter	Factory Default Condition
<b>Meas Setup:</b>	
Avg Number	10; On
Avg Mode	Repeat
Span	3.75000 MHz
Res BW	30.000 kHz
Trig Source	Free Run (Immediate)
Limit Test	On
Limit	1.48000 MHz
<b>Advanced</b>	
FFT Window	Gaussian (Alpha 3.5)

Make sure the **Occupied BW** measurement is selected under the **MEASURE** menu. The **Meas Setup** key accesses the menu which allows you to modify the average number, average mode, and trigger source for this measurement as described in [“Measurement Setup” on page 127](#).

In addition, the following parameters can be changed according to your measurement requirement:

- **Span** - Allows you to specify the frequency span in which the total power is measured. The range is 10.000 kHz to 10.0000 MHz with 1 Hz resolution.
- **Res BW** - Allows you to specify the resolution bandwidth value. The frequency range is 1.000 kHz to 1.00000 MHz. A narrower bandwidth will result in a longer data acquisition time but you will be able to examine the signal more closely.
- **Limit Test** - Allows you to toggle the limit test function between **On** and **Off**, for occupied bandwidth measurements.
- **Limit** - Allows you to specify the limit frequency value with which the limit test is made. The range is 10.000 kHz to 10.0000 MHz with 1 Hz resolution.
- **Advanced** - Allows you to access the selection menu of FFT windows.
  - **FFT Window** - Allows you to access the following selection menu for FFT windows. If you are familiar with FFT windows, you can

use other digital filters but the use of the flat top filter is recommended. Changes from the default setting may result in invalid data.

- **Flat Top** - Select this filter for best amplitude accuracy by reducing scalloping error.
- **Uniform** - Select this filter to have no active window.
- **Hanning** - Press this key to activate the Hanning filter.
- **Hamming** - Press this key to activate the Hamming filter.
- **Gaussian (Alpha 3.5)** - Press this key to activate the Gaussian filter with an alpha of 3.5.
- **Blackman** - Press this key to activate the Blackman filter.
- **Blackman-Harris** - Press this key to activate the Blackman-Harris filter.
- **K-B 70dB/90dB/110dB (Kaiser-Bessel)** - Allows you to select one of the Kaiser-Bessel filters with sidelobes at  $-70$ ,  $-90$ , or  $-110$  dB.

## Changing the View

The **View/Trace** key is not available for this measurement.

## Changing the Display

The **AMPLITUDE Y Scale** key accesses the menu to set the desired measurement scale and associated parameters:

- **Scale/Div** - Allows you to enter a numeric value to change the vertical display sensitivity. The range is 0.10 to 20.00 dB with 0.01 dB resolution. The default setting is 10.00 dB. However, since the **Scale Coupling** default is **On**, this value is automatically determined by the measurement result. When you set a value manually, **Scale Coupling** automatically changes to **Off**.
- **Ref Value** - Allows you to set the absolute power reference value ranging from  $-250.00$  to  $250.00$  dBm with 0.01 dB resolution. The default setting is 10.00 dBm. However, since the **Scale Coupling** default is **On**, this value is automatically determined by the measurement result. When you set a value manually, **Scale Coupling** automatically changes to **Off**.
- **Ref Position** - Allows you to set the reference position to either **Top**, **Ctr** (center), or **Bot** (bottom). The default setting is **Top**.
- **Scale Coupling** - Allows you to toggle the scale coupling function between **On** and **Off**. The default setting is **On**. Upon pressing the **Restart** front-panel key or the **Restart** softkey under the **Meas Control** menu, this function automatically determines the scale per division and reference values based on the measurement results. When you set a value to either **Scale/Div** or **Ref Value** manually, **Scale Coupling** automatically changes to **Off**.



## Using the Marker

The **Marker** key is not available for this measurement function.

## Troubleshooting Hints

Any distortion such as harmonics or intermodulation, for example, produces undesirable power outside the specified bandwidth.

Shoulders on either side of the spectrum shape indicate spectral regrowth and intermodulation. Rounding or sloping of the top shape can indicate filter shape problems.

---

## Making the Code Domain Measurement

### Purpose

Since the code domain measurements despread and descramble the cdma2000 signal into its physical channels, the number of active channels of various symbol rates (which are denoted by widths) can be observed. The width of the channel is inversely proportional to the Walsh code length in number of bits. In the code domain, there is a fixed amount of code space for a given chip rate. Therefore, by using the different Walsh codes, the system can dynamically allocate the code space for lower rate voice users versus high speed data users.

This code domain power composite view provides information about the in-channel characteristics of the cdma2000 signal. It directly informs the user of the active channels with their individual channel powers. The composite view also shows which data rates are active and the corresponding amount of code space used. The following are conditions under which a general unlock can occur: the Pilot signal is too low in power or no Pilot signal available, an incorrect long code is used for despreading, the frequency error is too large, or a frequency inversion is present.

When the level of the code domain noise floor is too high, relative to a reference or an expected level, one of the possible causes might be due to CW interference, like local oscillator feedthrough or spurs. I/Q modulation impairments can be another source of this uncorrelated noise. The I/Q demodulation measurements can reveal errors such as I/Q gain imbalance or I/Q quadrature error.

### Measurement Method

This procedure measures the power levels of the spread channels in composite RF channels. **Measure** in the **Meas Control** menu default is **Single** for this measurement.

The code domain measurement displays the power for each of the spread channels, relative to the total power within the 1.230 MHz channel bandwidth centered at the center frequency. Each spread channel level is displayed as an individual vertical bar with a different width determined by a spread rate. Because this is a relative measurement, the unit of measure is dB (not dBm or watts). This allows a comparison of signal levels between the Pilot and Traffic channels.

For E4406A Option B7C, this measurement is available for use with either the RF input or Baseband I/Q inputs. For detailed operation, see [“Using Option B7C Baseband I/Q Inputs” on page 238](#).

If **Device** is set to **MS**, the demodulated I and Q signals are individually shown in the code domain power graph window. Depending on the test equipment for MS, it is recommended that you use the trigger output signal from the instrument for synchronization.

The following displays are available for this measurement:

- **Power Graph & Metrics** - The transmitted energy associated with each of the symbol rates and Walsh codes is shown in the graph window. The following powers along with the total power are shown in the text window depending on the device selection:

**Table 4-12**

**Code Domain Channel Power Metrics**

For BTS	For MS
Total active channel power Pilot channel power Synch channel power Time offset	Total active channel power Pilot channel power
Maximum active channel power Average active channel power Maximum inactive channel power Average inactive channel power Number of active channels	I average active channel power I maximum inactive channel power Q average active channel power Q maximum inactive channel power

- **I/Q Error (Quad View)** - The magnitude error, phase error, and EVM graphs are individually shown in the graph windows. The summary data for these parameters are also shown in the text window.
- **Code Domain (Quad View)** - The graphs of the code domain power, the symbol power for the selected spread channel, and the I/Q symbol power polar vector for the symbol power range selected by the measurement interval and measurement offset parameters, are shown in the graph windows. The symbol EVM summary data is also shown in the text window.
- **Demod Bits** - In addition to the graphs of the code domain power and the symbol power for the selected spread channel, the demodulated bit stream data can be shown for the selected slots of the symbol power in the text window.

## Making the Measurement

**NOTE**

The factory default settings provide a cdma2000 compliant measurement. For special requirements, you may need to change some of the settings. Press **Meas Setup, More, Restore Meas Defaults** at any time to return all parameters for the current measurement to their default settings.

Select the desired center frequency as described in [“Changing the](#)

Frequency Channel” on page 83.

For PSA, if Option 1DS Internal Preamplifier is installed, it will be available for this measurement. See “Configuring the Input Condition” on page 75 for details of **Int Preamp** and **Attenuator** operation.

Press **MEASURE, Code Domain** to immediately make a code domain power measurement.

To change any of the measurement parameters from the factory default values, refer to “Changing the Measurement Setup” on page 173.

For E4406A Option B7C, this measurement is available for use with either the RF input or Baseband I/Q inputs. For detailed operation, see “Using Option B7C Baseband I/Q Inputs” on page 238.

## Results

The next figure shows an example result of a Code Domain Power measurement. In the graph window, the active channel Walsh code and symbol rates are shown with those widths of the bars and the measured channel powers are shown with those heights. In addition to the total power, powers for total active channels, pilot channel, synchronizing channel, and the number of active channels and time offset, are shown in the text window.

Figure 4-10

Code Domain Measurement - Power Graph View

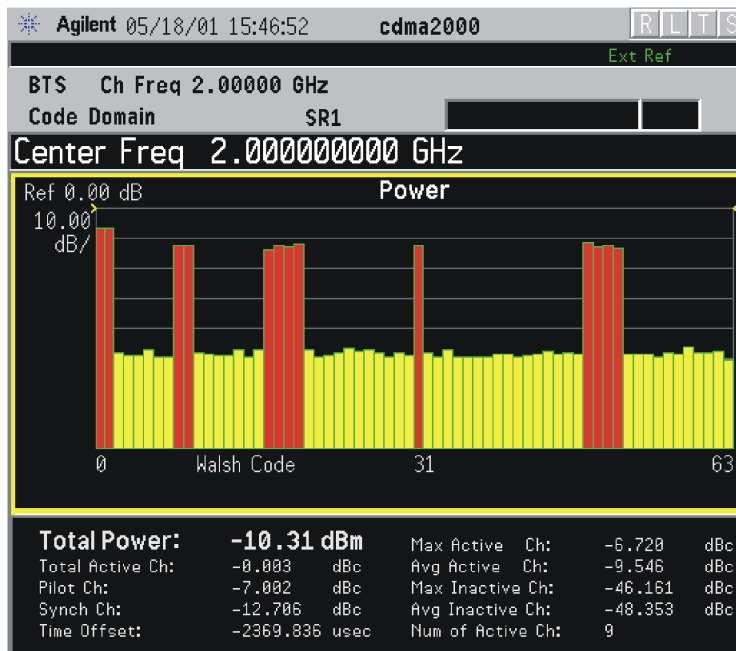

\*Meas Setup: Factory default settings

\*Input signal: -10.00 dBm, 9 channels of SR1, cdma2000 Rev 8

## Changing the Measurement Setup

The next table shows the factory default settings for code domain power measurements.

**Table 4-13** Code Domain Power Measurement Defaults

Measurement Parameter	Factory Default Condition
View/Trace	Power Graph & Metrics
Display:	
Code Order	Hadamard
Base Code Length	64
Consolidated Marker	On
Composite	On
Walsh Code Length	64
Meas Setup:	
Meas Type	Rel (relative)
Walsh Code Length	32
Walsh Code Number	0
Walsh Code QOF	0
Meas Interval	1 PCG
Meas Offset	0 PCG
Long Code Mask (grayed out)	20000000000 (for MS tests)
Capture Intvl	5 PCG
Trig Source	Free Run (Immediate)
Spectrum	Normal
Meas Control:	
Measure	Single
<b>Advanced</b>	
Active Set Th	Auto; ---- dB
Chip Rate	1.228800 MHz
ADC Range	-6 dB (for E4406A), None (for PSA)

Make sure the **Code Domain** measurement is selected under the **MEASURE** menu. Press the **Meas Setup** key to access the menu which allows you to modify the trigger source for this measurement as described in [“Measurement Setup” on page 127](#). Also, press the **Meas Control** key to access the menu which allows you to change **Measure** from **Single** to **Cont** (continuous) as described in [“Measurement Control” on page 126](#).

In addition, the following parameters can be changed according to your measurement requirement:

- **Meas Type** - Allows you to toggle the code domain power measurement type between **Rel** (relative) and **Abs** (absolute). If set to **Rel**, the measurement is made in the relative power in dBc. If set to **Abs**, the measurement is made in the absolute power in dBm.
- **Walsh Code Length** - Allows you to set the Walsh code length ranging from 4 to 128 ( $= 2^{n+2}$  where  $n = 0$  to 5) for BTS measurements, or from 2 to 32 for MS measurements. The parameter automatically sets the maximum value for **Walsh Code Number** when appropriate. If **Walsh Code Length** is set to 64 and **Code Number** is set to 0, the Pilot channel is automatically selected as the channel type. When the channel type is set to Pilot, the search code portion is not included in the symbol EVM calculation. In other cases, the channel type is set to DCCCH (dedicated control channel) which enables power offset measurements.
- **Walsh Code Number** - Allows you to set the Walsh code number. The range is 0 to (**Walsh Code Length** – 1).
- **Walsh Code QOF** - Allows you to access the menu to specify a value 0, 1, 2, or 3 to the Walsh code quasi-orthogonal function for expanding the number of downlink channels (subscribers). **Walsh Code QOF** under the **Display** menu is identical with this key. These keys are available if **Device** is set to **BTS**.

If **Device** is set to **MS**, this key reads **I/Q Branch** and allows you to toggle the selection of the I/Q branch signals between **I** and **Q**. The default selection is **I**.

- **Meas Interval** - Allows you to set the time interval in PCG (power control groups) over which the symbol power measurement is made. The range is 1 to ( $32 - \text{Meas Offset}$ ) PCG. The marker lines reflecting this value are displayed in the symbol power graph of the **Code Domain (Quad View)** and **Demod Bits** displays. Refer to the illustration in **Meas Offset** below.
- **Meas Offset** - Allows you to set the number of offsets in PCG (power control groups) to make the symbol power measurement. The range is 0 to 31 PCG in conjunction with the **Meas Interval** value. The maximum value is 32 minus the **Meas Interval** value. The marker lines shift left or right by this value in the symbol power graph of the **Code Domain (Quad View)** and **Demod Bits** displays. The following illustration shows the relationship between the capture interval and the measurement interval.

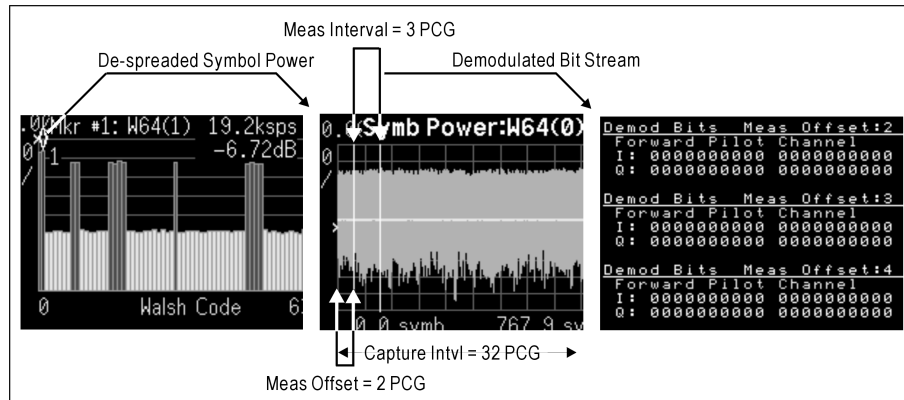

- **PN Offset** - Allows you to set the number of PN offsets in the unit of 64 chips to make the symbol power measurement. The range is 0 to 511. This value corresponds to the time offset between the trigger signal and the external frame signal.
- **Long Code Mask** - Allows you to set the long code mask to either 0000000000 or 2000000000. This value is used in the long code generation process. This key is available if **Device** is set to **MS**, otherwise grayed out.
- **Capture Intvl** - Allows you to set the number of power control groups to make the symbol power measurement. The range is 2 to 32 PCG in conjunction with the **Meas Interval** value. The maximum value is (32 – **Meas Interval**). The marker lines shift to the right or left by this value in the symbol power graph of the **Code Domain (Quad View)** and **Demod Bits** display.
- **Spectrum** - Allows you to toggle the spectrum function between **Normal** and **Invert**. This key, when set to **Invert**, conjugates the spectrum, which equivalently negates the quadrature component in demodulation. The correct setting (**Normal** or **Invert**) depends on whether the signal being input to the instrument has a high or low side mix.
- **Advanced** - Allows you to access the menu to set the following parameter.
  - **Active Set Th** - Allows you to toggle the active channel identification function between **Auto** and **Man**. If set to **Auto**, the active channels are determined automatically by the internal algorithm. If set to **Man**, the active channel identification for each code channel is determined by a user definable threshold ranging from 0.00 to -100.00 dB.
  - **Chip Rate** - Allows you to change the chip rate. The range is 1.10592 to 1.35168 MHz.
  - **ADC Range** - Allows you to access the following selection menu to

define one of the ADC ranging functions:

- **Auto** - Select this to automatically set the ADC range. For most FFT measurements, the auto feature should not be selected. An exception is when measuring a “bursty” signal, in which case **Auto** can maximize the time domain dynamic range, if FFT results are less important to you than time domain results.
- **Auto Peak** - Select this to set the ADC range automatically to the peak signal level. **Auto Peak** is a compromise that works well for both CW and burst signals.
- **Auto Peak Lock** - Select this to hold the ADC range automatically at the peak signal level. **Auto Peak Lock** is more stable than **Auto Peak** for CW signals, but should not be used for “bursty” signals.
- **Manual** - Allows you to access the selection menu of values, -6 to +24 dB for E4406A or None to +18 dB for PSA, to set the ADC range level. Also note that manual ranging is best for CW signals.

## Changing the View

The **View/Trace** key will allow you to select the desired view of the measurement from the following. Each of these views contains multiple windows that can be selected by the **Next Window** key and made full size using the **Zoom** key.

- **Power Graph & Metrics** - Provides a combination view of the code domain power graph and the summary data as shown in [Figure 4-10 on page 172](#).
- **I/Q Error (Quad View)** - Provides a combination view of the magnitude error, phase error, and EVM graphs, and the summary data for the code number, rms and peak EVM's, magnitude error, phase error, absolute total power, and channel power in the text window as shown in [Figure 4-11](#).



**Figure 4-11 Code Domain Measurement - I/Q Error with Quad View**

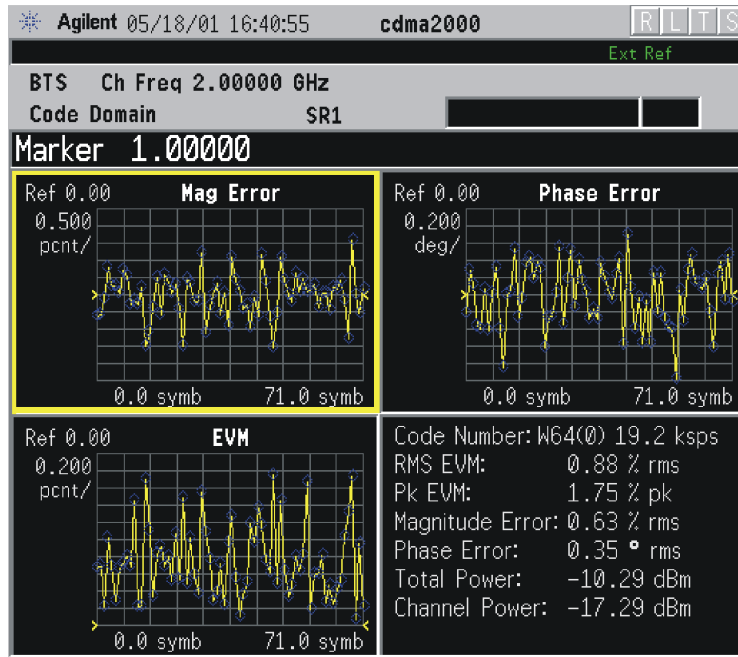

\*Meas Setup: View/Trace = I/Q Error (Quad View),  
Others = Factory default settings

\*Input signal: -10.00 dBm, 9 channels of SR1, cdma2000 Rev 8

- **Code Domain (Quad View)** - Provides a combination view of the code domain power, symbol power, and I/Q symbol power polar vector graphs in the graph window, and the summary data for the code number, rms and peak EVM's, magnitude error, phase error, absolute total power, and channel power in the text window as shown in [Figure 4-12](#).

**Figure 4-12 Code Domain Measurement - Code Domain with Quad View**

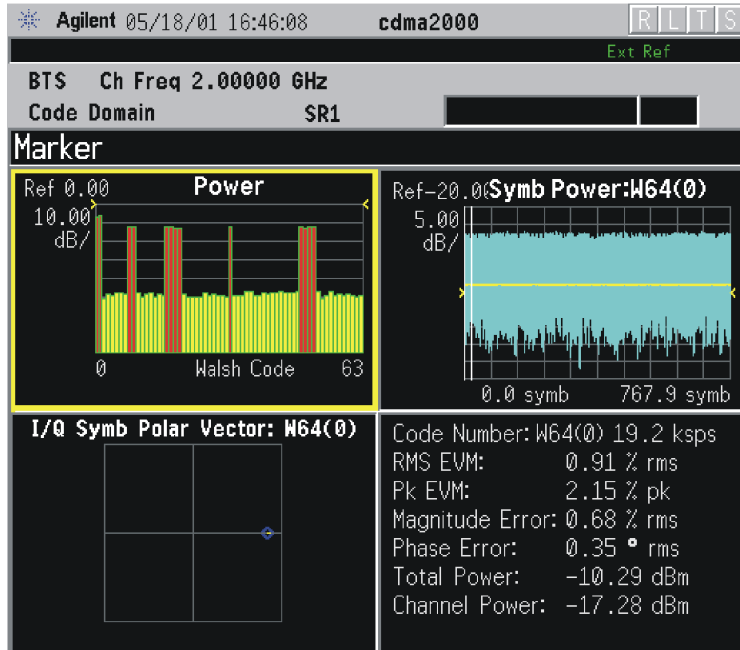

\*Meas Setup: View/Trace = Code Domain (Quad View),  
 Others = Factory default settings

\*Input signal: -10.00 dBm, 9 channels of SR1, cdma2000 Rev 8

- **Demod Bits** - Provides a combination view of the code domain power and symbol power graphs, and the I/Q demodulated bit stream data with the corresponding slot or measure offset number in the power control groups, in the text window as shown in [Figure 4-13](#).

**Figure 4-13 Code Domain Measurement - Demod Bits View**

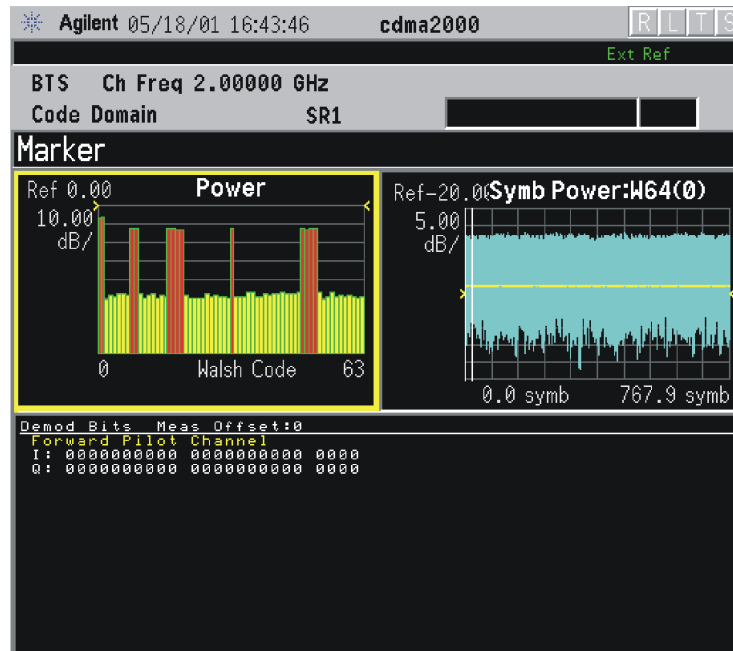

\*Meas Setup: View/Trace = Demod Bits,  
Others = Factory default settings

\*Input signal: -10.00 dBm, 9 channels of SR1, cdma2000 Rev 8

While the Code Domain Power graph is active, press the **Marker** key to place a marker on any active spread channel. Then, press the **Mkr->Despread** key to observe the Symbol Power and the I/Q Symbol Polar Vector graphs with the Walsh code number for that active channel in other graph windows. The I/Q symbol polar vector graph and the demodulated bit stream are displayed for the symbol power specified by the measurement interval and measurement offset.

## Changing the Display

To change the display parameters, the **Display**, **SPAN X Scale**, and **AMPLITUDE Y Scale** keys are available, depending on the window selected.

In symbol power measurements in the code domain, phase trajectories between constellation points are not significant to the measurement. Therefore, by default, the points per chip is always set to 1 and **Chip Dots** is set to On.

If the Power graph window is active in the **Code Domain**, **Code Domain (Quad View)**, or **Demod Bits** view, the **Display** key accesses the menu to allow the following settings:

- **Code Order** - Allows you to access the selection menu for the Walsh code order function.

— **Hadamard** - Allows you to set the Walsh code order function to Hadamard. The next figure shows code domain power graphs for Walsh Code4 and OVSF Code 4 to illustrate their relationship.

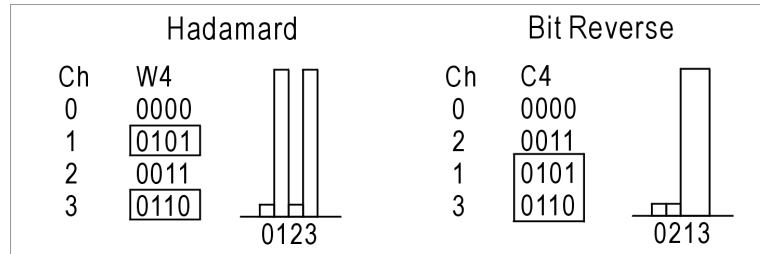

— **Bit Reverse** - Allows you to set the Walsh code order function to Bit Reverse. When selected, the **Consolidated Marker** key is disabled.

- **Base Code Length** - Allows you to toggle the Walsh base code length between **64** and **128**.
- **Consolidated Marker** - Allows you to toggle the consolidated marker function between **On** and **Off**. If set to **On**, the corresponding Walsh code channel power will be marked in the different color upon placing the marker at the consolidated Walsh code channel power. The **Consolidated Marker** key is disabled when the **Code Order Bit Reverse** key is selected.
- **Composite** - Allows you to toggle the composite code channel power display function between **On** and **Off**.
- **Walsh Code Length** - Allows you to set the Walsh code length displayed on the screen to read the total power level of the combined code channels. The choices are 4, 8, 16, 32, 64, and 128 for BTS, and 2, 4, 8, 16, 32 for MS.

If the **Symbol Power** window is active in the **Code Domain (Quad View)** or **Demod Bits**, the **Display** key accesses the menu to allow the following settings:

- **Composite Chip Power** - Allows you to toggle the composite chip power display function between **On** and **Off**. The default setting is **On**.

If the **Demod Bits** window is active in the **Demod Bits** view, the **Display** key accesses the menu to allow the following controls to read the bit stream measurement results:

- **Prev Page** - Returns one page back to the previous page of the measurement results.
- **Next Page** - Moves one page forward to the next page of the measurement results.
- **Scroll Up** - Moves one line upward from the current page of the measurement results by each pressing.
- **Scroll Down** - Moves one line downward from the current page of the

measurement results by each pressing.

- **First Page** - Moves from the current page to the first page of the measurement results.
- **Last Page** - Moves from the current page to the last page of the measurement results.

If the `Power` window is active in the **Power Graph & Metrics, Code Domain (Quad View)**, or **Demod Bits** view, the **SPAN X Scale** and **AMPLITUDE Y Scale** keys access the menus to allow the following settings:

- With the **SPAN X Scale** key:
  - **Scale/Div** - Allows you to set the horizontal scale by changing a spread code value. The range is 64.00 to 128.0 Walsh spread codes. The default setting is 64.00 Walsh spread codes.
  - **Ref Value** - Allows you to set the spread code reference value. The range is 0.000 to 64.00 Walsh spread codes with the scale at least 64 Walsh spread codes. The default setting is 0.000 Walsh spread code.
  - **Ref Position** - Allows you to set the reference position to either **Left**, **Ctr** (center) or **Right**. The default setting is **Left**.
  - **Expand** - Allows you to toggle the expanding function of the Walsh code domain power graph between **On** and **Off**. If set to **On**, the power graph is expanded horizontally to show 64 Walsh spread codes centered at the scale or the marker position. Upon toggling back to **Off**, the Walsh spread code range returns to the previous setting.
- With the **AMPLITUDE Y Scale** key:
  - **Scale/Div** - Allows you to set the vertical scale by changing the value per division. The range is 0.10 to 20.0 dB per division. The default setting is 5.00 dB.
  - **Ref Value** - Allows you to set the reference value ranging from -250.00 to 250.00 dB. The default setting is 0.00 dB.

If `Symbol Power` window is active, the **SPAN X Scale** key accesses the following menu:

- With the **SPAN X Scale** key:
  - **Scale/Div** - Allows you to set the horizontal scale by changing a symbol value per division. The range is 1.000 to 100.0 symbols per division with 0.01 symbol resolution. The default setting is 11.90 symbols. However, since **Scale Coupling** default is **On**, this value is automatically determined by the measurement result. When you set a value manually, **Scale Coupling** automatically changes to **Off**.
  - **Ref Value** - Allows you to set the symbol reference value ranging

from 0.000 to 1000.0 symbols. The default setting is 0.000 symbol. However, since **Scale Coupling** default is **On**, this value is automatically determined by the measurement results. When you set a value manually, **Scale Coupling** automatically changes to **Off**.

- **Ref Position** - Allows you to set the reference position to either **Left**, **Ctr** (center) or **Right**. The default setting is **Left**.
- **Scale Coupling** - Allows you to toggle the scale coupling function between **On** and **Off**. The default setting is **On**. Upon pressing the **Restart** front-panel key or the **Restart** softkey under the **Meas Control** menu, this function automatically determines the scale per division and reference values based on the measurement results. When you set a value to either **Scale/Div** or **Ref Value** manually, **Scale Coupling** automatically changes to **Off**.
- With the **AMPLITUDE Y Scale** key:
  - **Scale/Div** - Allows you to set the vertical scale by changing the value per division. The range is 0.10 to 20.00 dB. The default setting is 5.00 dB. However, since **Scale Coupling** default is **On**, this value is automatically determined by the measurement result. When you set a value manually, **Scale Coupling** automatically changes to **Off**.
  - **Ref Value** - Allows you to set the reference value ranging from -250.00 to 250.00 dB. The default setting is 0.00 dB. However, since **Scale Coupling** default is **On**, this value is automatically determined by the measurement results. When you set a value manually, **Scale Coupling** automatically changes to **Off**.
  - **Ref Position** - Allows you to set the reference position to either **Top**, **Ctr** (center) or **Bot** (bottom). The default setting is **Ctr**.
  - **Scale Coupling** - Allows you to toggle the scale coupling function between **On** and **Off**. The default setting is **On**. Upon pressing the **Restart** front-panel key or the **Restart** softkey under the **Meas Control** menu, this function automatically determines the scale per division and reference values based on the measurement results. When you set a value to either **Scale/Div** or **Ref Value** manually, **Scale Coupling** automatically changes to **Off**.

If either EVM, Phase Error, or Mag Error window is active in the **I/Q Error (Quad View)** view, the **SPAN X Scale** key accesses the menu to allow the following settings:

- **Scale/Div** - Allows you to set the horizontal scale by changing a symbol value per division. The range is 1.00 to 100.00 symbols per division with 0.01 symbol resolution. The default setting is 1.900 symbols. However, since **Scale Coupling** default is **On**, this value is automatically determined by the measurement result. When you set a value manually, **Scale Coupling** automatically changes to **Off**.

- **Ref Value** - Allows you to set the symbol reference value ranging from 0.00 to 1000.0 symbols. The default setting is 0.00 symbol. However, since **Scale Coupling** default is **On**, this value is automatically determined by the measurement results. When you set a value manually, **Scale Coupling** automatically changes to **Off**.
- **Ref Position** - Allows you to set the reference position to either **Left**, **Ctr** (center) or **Right**. The default setting is **Left**.
- **Scale Coupling** - Allows you to toggle the scale coupling function between **On** and **Off**. The default setting is **On**. Upon pressing the **Restart** front-panel key or the **Restart** softkey under the **Meas Control** menu, this function automatically determines the scale per division and reference values based on the measurement results. When you set a value to either **Scale/Div** or **Ref Value** manually, **Scale Coupling** automatically changes to **Off**.

If either EVM or Mag Error window is active in the **I/Q Error (Quad View)** view, the **AMPLITUDE Y Scale** key accesses the menu to allow the following settings:

- **Scale/Div** - Allows you to set the vertical scale by changing the value per division. The range is 0.100 to 50.0% per division. The default setting is 5.00%. However, since **Scale Coupling** default is **On**, this value is automatically determined by the measurement result. When you set a value manually, **Scale Coupling** automatically changes to **Off**.
- **Ref Value** - Allows you to set the reference value ranging from -500.00 to 500.0%. The default setting is 0.00%. However, since **Scale Coupling** default is **On**, this value is automatically determined by the measurement results. When you set a value manually, **Scale Coupling** automatically changes to **Off**.
- **Ref Position** - Allows you to set the reference position to either **Top**, **Ctr** (center) or **Bot** (bottom). For the EVM graph, the default setting is **Bot**. For the Mag Error graph, the default setting is **Ctr**.
- **Scale Coupling** - Allows you to toggle the scale coupling function between **On** and **Off**. The default setting is **On**. Upon pressing the **Restart** front-panel key or the **Restart** softkey under the **Meas Control** menu, this function automatically determines the scale per division and reference values based on the measurement results. When you set a value to either **Scale/Div** or **Ref Value** manually, **Scale Coupling** automatically changes to **Off**.

If the Phase Error window is active in the **I/Q Error (Quad View)** view, the **AMPLITUDE Y Scale** key accesses the menu to allow the following settings:

- **Scale/Div** - Allows you to set the vertical scale by changing the value per division. The range is 0.0100 to 3600.0 degrees. The default setting is 5.00 degrees. However, since **Scale Coupling** default is **On**,

this value is automatically determined by the measurement result. When you set a value manually, **Scale Coupling** automatically changes to **Off**.

- **Ref Value** - Allows you to set the reference value ranging from -36000.0 to 36000.0 degrees. The default setting is 0.00 degrees. However, since **Scale Coupling** default is **On**, this value is automatically determined by the measurement results. When you set a value manually, **Scale Coupling** automatically changes to **Off**.
- **Ref Position** - Allows you to set the reference position to either **Top**, **Ctr** (center) or **Bot** (bottom). The default setting is **Ctr**.
- **Scale Coupling** - Allows you to toggle the scale coupling function between **On** and **Off**. The default setting is **On**. Upon pressing the **Restart** front-panel key or the **Restart** softkey under the **Meas Control** menu, this function automatically determines the scale per division and reference values based on the measurement results. When you set a value to either **Scale/Div** or **Ref Value** manually, **Scale Coupling** automatically changes to **Off**.

## Using the Print Function

In addition to the normal menu of the **Print Setup** front-panel key, one selection key is added to configure the print function if **View/Trace** is set to **Demod Bits**.

- **Print Demod** - Allows you to toggle the print function between **Screen** and **Report**. The default setting is **Screen** to dump a screen image. To create a text file of the demodulated data bits, press **Print Setup**, **HCOPY Dest**, select = **Print To Key**, and toggle the **Print Demod** key to **Report**. A text file named “demodbit.txt” will be written to the destination drive selected.

## Using the Markers

The **Marker** front-panel key accesses the menu to configure the markers depending on the display selected.

- **Select** - Allows you to activate up to four markers with the corresponding numbers, respectively. The selected number is underlined and its function is defined by pressing the **Function** key. The default setting is 1.
- **Normal** - Allows you to activate the selected marker to read the power level and symbol code with the code layer. The marker position is controlled either by manual adjustment of the RPG knob or by direct entry of the Walsh code number via the front panel keypad.
- **Delta** - Allows you to read the differences in the power levels and symbols codes between the selected marker and the next.



- **Function** - Allows you to set the selected marker function to **Band Power**, **Noise**, or **Off**. The default setting is **Off**. The **Band Power** and **Noise** functions are not available for this measurement.
- **Trace** - Allows you to place the selected marker on the **Code Domain Power**, **Symbol Power**, **Chip Power**, **EVM**, **Phase Error**, or **Mag Error** trace. The default setting is **Code Domain Power**.
- **Off** - Allows you to turn off the selected marker.
- **Shape** - Allows you to access the menu to set the selected marker shape to **Diamond**, **Line**, **Square**, or **Cross**. The default setting is **Diamond**.
- **Marker All Off** - Allows you to turn off all of the markers.
- **Mkr→Despread** - While a marker is set on any active spread channel of the code domain power graph in the **Power Graph and Metrics**, **Code Domain (Quad View)**, or **Demod Bits** view, this key allows you to observe the Symbol Power and the I/Q Symbol Polar Vector graphs with the Walsh spread code number for that active channel in other windows. The I/Q symbol polar vector graph is displayed for the symbol power specified by the measurement interval and measurement offset.

The front panel **Search** key performs a peak search when pressed. A marker will automatically be activated at the highest peak.

## Troubleshooting Hints

Uncorrelated interference may cause CW interference like local oscillator feedthrough or spurs. Another uncorrelated noise may be due to I/Q modulation impairments. Correlated impairments can be due to the phase noise on the local oscillator in the upconverter or I/Q modulator of the UUT. These will be analyzed by the code domain measurements along with the QPSK EVM measurements and others.

A poor phase error indicates a problem at the I/Q baseband generator, filters, and/or modulator in the transmitter circuitry of the UUT. The output amplifier in the transmitter can also create distortion that causes unacceptably high phase error. In a real system, a poor phase error will reduce the ability of a receiver to correctly demodulate the received signal, especially in marginal signal conditions.

---

## Making the Modulation Accuracy (Composite Rho) Measurement

### Purpose

Rho is one of the key modulation quality metrics, along with EVM and code domain power. Rho is the ratio of the correlated power in a single coded channel to the total signal power. This is a simplified case of code domain power since this measurement is made on a single coded channel. This measurement takes into account all possible error mechanisms in the entire transmission chain including baseband filtering, I/Q modulation anomalies, filter amplitude and phase non-linearities, and power amplifier distortion. This provides an overall indication of the performance level of the transmitter of the UUT.

### Measurement Method

This procedure measures the performance of the transmitter's modulation circuitry.

In a digitally modulated signal, it is possible to predict what the ideal magnitude and phase of the carrier should be at any time, based on the transmitted data sequence. The transmitter's modulated signal is compared to an ideal signal vector. The difference between these two vectors is sampled and processed using DSP. Rho values are in the range of 0 to 1. A value of 1 indicates perfect correlation to the reference (high modulation quality). The cdma2000 base station standards require that transmitters have a Rho performance of 0.912 or greater.

For E4406A Option B7C, this measurement is available for use with either the RF input or Baseband I/Q inputs. For detailed operation, see [“Using Option B7C Baseband I/Q Inputs” on page 238](#).

Depending on the test equipment for MS, it is recommended that you use the trigger output signal from the instrument for synchronization.

If the error code 604 “Can not correlate to input signal” is shown, it means that your measurement has failed to find any active channels due to the lack of correlation with the input signal. The input signal level, for example, may need to be adjusted to obtain correlation.

With the Rho measurement, the following data is provided:

- Rho - modulation quality representing the ratio of the correlated power in a single coded channel to the total signal power
- EVM - peak and rms error vector magnitude
- Peak CDE - peak code domain error with that code number

- Magnitude Error - rms magnitude error
- Phase Error - rms phase error
- Freq Error - the frequency difference between the transmitter's actual center frequency and the frequency (or channel) that you entered
- I/Q Origin Offset - the origin offset for I/Q signals
- No. of Active Channels
- Time Offset - the time offset between the I and Q signals

## Making the Measurement

---

### NOTE

The factory default settings provide a cdma2000 compliant measurement. For special requirements, you may need to change some of the settings. Press **Meas Setup, More, Restore Meas Defaults** at any time to return all parameters for the current measurement to their default settings.

---

Select the desired center frequency as described in [“Changing the Frequency Channel” on page 83](#).

For PSA, if Option 1DS Internal Preamplifier is installed, it will be available for this measurement. See [“Configuring the Input Condition” on page 75](#) for details of **Int Preamp** and **Attenuator** operation.

Press **MEASURE, Mod Accuracy (Composite Rho)** to immediately make a modulation accuracy measurement.

To change any of the measurement parameters from the factory default values, refer to [“Changing the Measurement Setup” on page 189](#).

For E4406A Option B7C, this measurement is available for use with either the RF input or Baseband I/Q inputs. For detailed operation, see [“Using Option B7C Baseband I/Q Inputs” on page 238](#).

## Results

The following figure shows an example result of I/Q Measured Polar Vector for the modulation accuracy measurements in the graph window. The measured values for Rho, rms and peak EVM, peak code domain error with the code number, rms magnitude error, rms phase error, and other parameters are shown in the text window.

Figure 4-14

### Modulation Accuracy Measurement - Polar Vector View

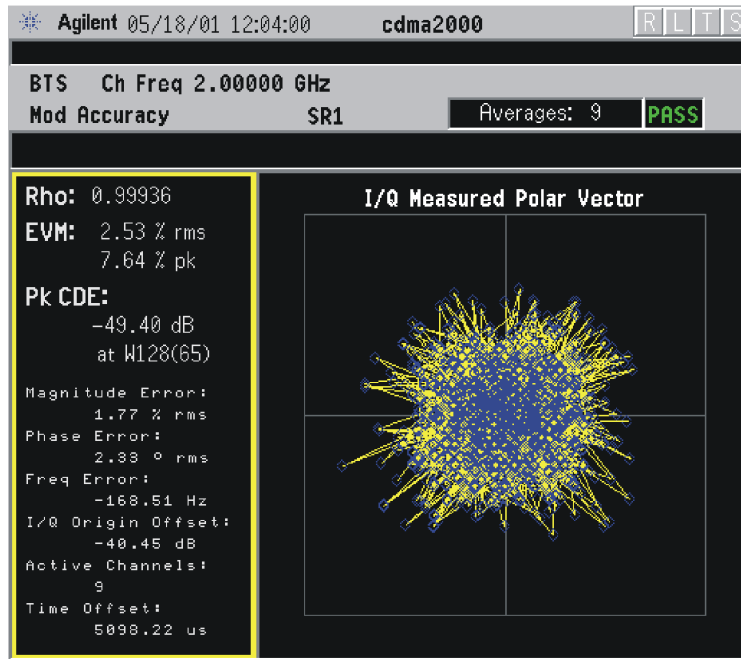

\*Meas Setup: Factory default settings

\*Input signal: 0.00 dBm, 9 channels of SR1, cdma2000 Rev 8

## Changing the Measurement Setup

This table shows the factory default settings for modulation accuracy (composite rho) measurements.

**Table 4-14 Modulation Accuracy (Composite Rho) Measurement Defaults**

Measurement Parameter	Factory Default Condition
View/Trace	I/Q Measured Polar Vector
Display:	
I/Q Polar Vec/Constln	Vec & Constln
Chip Offset	10 chips
Chip Interval	1516 chips
+45 deg Rot	Off
Full Vector (Background)	Off
Meas Setup:	
Avg Number	10; On
Avg Mode	Repeat
Limits:	
RMS EVM (Composite)	50.0 pct
Peak EVM (Composite)	100.0 pct
Rho (Composite)	0.91200
Peak Code Domain Error	0.0 dB
Timing	50.0 ns
Phase	0.05 rad
Trig Source	Free Run (Immediate)
PN Offset	0 × 64 [chips]
Long Code Mask (grayed out)	20000000000 (for MS tests)
Spectrum	Normal
<b>Advanced</b>	
EVM Result I/Q Offset	Std
Active Set Th	Auto
Chip Rate	1.228800 MHz
Multi Channel Estimator	Off
ADC Range	-6 dB (for E4406A), None (for PSA)

Make sure the **Mod Accuracy (Composite Rho)** measurement is selected under the **MEASURE** menu. Press the **Meas Setup** key to access a menu which allows you to modify the average number, average mode, and trigger source as described in “[Measurement Setup](#)” on page 127. The chip rate is fixed at 1.2288 MHz for SR1 in this measurement.

In addition, the following modulation accuracy measurement parameters can be modified.

- **Limits** - Allows you to access the menu to set the following limits:
  - **RMS EVM (Composite)** - Allows you to set the limit for composite RMS EVM measurement result. The range is 0.00 to 50.00%.
  - **Peak EVM (Composite)** - Allows you to set the limit for composite peak EVM measurement result. The range is 0.00 to 100.00%.
  - **Rho (Composite)** - Allows you to set the limit for composite rho measurement result. The range is 0.00000 to 1.00000. For MS tests, the default value changes to 0.94400.
  - **Peak Code Domain Error** - Allows you to set the limit for peak code domain error measurement result. The range is 0.0 to -100.0 dBm.
  - **Timing** - Allows you to set the limit for timing tolerance tests used in the **Power Timing & Phase** view. The range is 0.0 to 500.0 ns. For MS tests, the default value changes to 10.0 ns.
  - **Phase** - Allows you to set the limit for phase tolerance tests used in the **Power Timing & Phase** view. The range is 0.00 to 3.00 rad.
- **PN Offset** - Allows you to specify a multiplier for the Walsh code length of 64 chips. The range is 0 to 511. For example, set a value of 16 from the numeric keypad and press the **Enter** key. PN Offset 16 × 64 [chips] will be displayed in the screen annotation area.
- **Long Code Mask** - Allows you to access the menu to set the long code mask to either 20000000000 or 00000000000. This value is used in the long code generation process. This key is available if **Device** is set to **MS**, otherwise this key is grayed out.
- **Spectrum** - Allows you to toggle the spectrum function between **Normal** and **Invert**. When set to **Invert**, it conjugates the spectrum, which effectively inverts the quadrature component in demodulation. The correct setting (**Normal** or **Invert**) depends on whether the signal being input to the instrument has a high or low side mix.
- **Advanced** - Allows you to access the menu to change the following parameters:
  - **EVM Result I/Q Offset** - Allows you to toggle the I/Q origin offset function between **Std** (standard) and **Exclude**. If set to **Std**, the

measurement results for EVM, Rho, and code domain error take into account the I/Q origin offset. If set to **Exclude**, the measurement results for EVM, Rho, and code domain error do not take into account the I/Q origin offset, and the message “EVM excludes I/Q Offset” is displayed in the lower right-hand graph display area. The default setting is **Std**.

- **Active Set Th** - Allows you to toggle the active channel identification function between **Auto** and **Man**. If set to **Auto**, the active channels are determined automatically by the internal algorithm. If set to **Man**, the active channel identification for each code channel is determined by a user definable threshold ranging from 0.00 to -100.00 dB.
- **Chip Rate** - Allows you to change the chip rate ranging from 1.10592 to 1.35168 MHz.
- **Multi Channel Estimator** - Allows you to toggle the multi channel estimator function between **On** and **Off**. When set to **On**, the **Power Timing and Phase** view will be available, and the measurement accuracy will be improved, but measurement speed will be reduced.
- **ADC Range** - Allows you to access the following selection menu to define one of the ADC ranging functions:
  - **Auto** - Select this to automatically set the ADC range. For most FFT measurements, the auto feature should not be selected. An exception is when measuring a “bursty” signal, in which case **Auto** can maximize the time domain dynamic range, if FFT results are less important to you than time domain results.
  - **Auto Peak** - Select this to set the ADC range automatically to the peak signal level. **Auto Peak** is a compromise that works well for both CW and burst signals.
  - **Auto Peak Lock** - Select this to hold the ADC range automatically at the peak signal level. **Auto Peak Lock** is more stable than **Auto Peak** for CW signals, but should not be used for “bursty” signals.
  - **Manual** - Allows you to access the selection menu of values, -6 to +24 dB for E4406A or None to +18 dB for PSA, to set the ADC range level. Also note that manual ranging is best for CW signals.

## Changing the View

The **View/Trace** key will allow you to select the desired measurement view from the following selections:

- **I/Q Measured Polar Graph** - Provides a combination view of an I/Q measured polar vector graph and the summary data as shown in [Figure 4-14 on page 188](#).
- **I/Q Error (Quad-View)** - Four display windows show Mag Error, Phase Error, and EVM graphs, and the summary data for the composite rho, rms and peak EVM, peak code domain error with the code number, rms magnitude error, rms phase error, frequency error, and other parameters as shown in [Figure 4-15](#).

**Figure 4-15 Modulation Accuracy Measurement - I/Q Error Quad View**

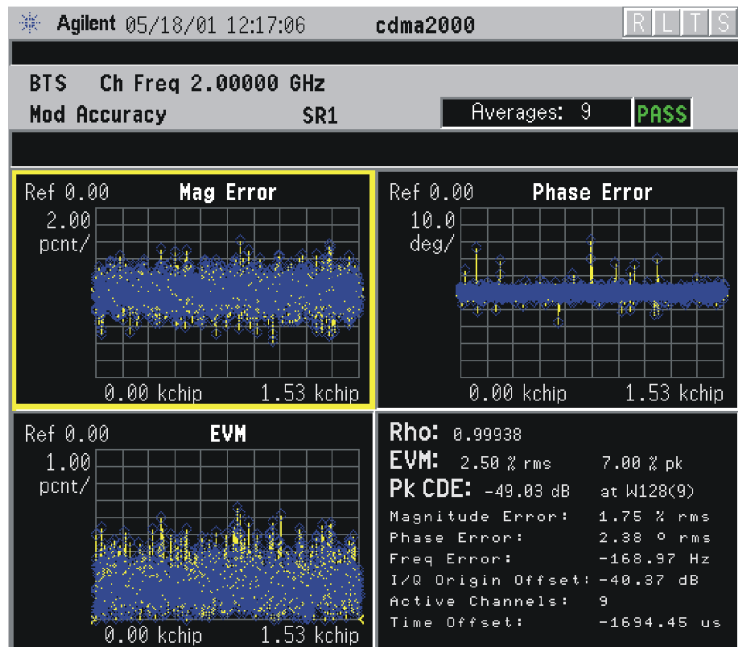

\*Meas Setup: View/Trace = Power Timing and Phase  
 Others = Factory Default Settings

\*Input signal: 0.00 dBm, 9 channels of SR1, cdma2000 Rev 8

Any one of these windows can be selected by the **Next Window** key and made full size using the **Zoom** key.

- **Power Timing & Phase** - Provides a measurement result for the active channels with power levels, timing, phase, and code domain errors in tabular form. Timing and phase are referenced to the Pilot channel as shown in [Figure 4-16](#). To activate this view, press **Meas Setup**, **More**, **Advanced**, and toggle **Multi Channel Estimator** to **ON**.

**Figure 4-16 Modulation Accuracy Measurement - Power, Timing, and Phase**



**View**

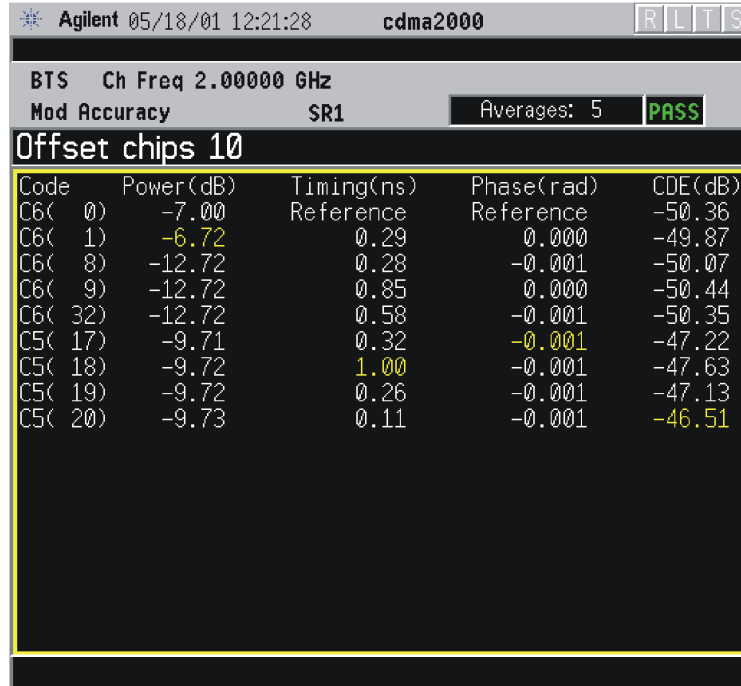

\*Meas Setup: Advanced/Multi Channel Estimator = ON  
 View/Trace = Power Timing & Phase,  
 Others = Factory default settings

\*Input signal: -10.00 dBm, 9 channels of SR1, cdma2000 Rev 8

**Changing the Display**

The **Display** key accesses a menu which makes available the following selections to change the displays for I/Q Measured Polar Vector, I/Q Measured Polar Constln, and I/Q Error (Quad View):

- **I/Q Polar Vec/Constln** - Allows you to access the following menu to select vector and/or constellation display.
  - **Vect & Constln** - Sets to display the I/Q polar graph with the vector trajectory traces and constellation spots.
  - **Vec** - Sets to display the I/Q polar graph with the vector trajectory traces.
  - **Constln** - Sets to display the I/Q polar graph with the constellation spots.
- **Chip Offset** - Allows you to specify the number of chips offset from the first chip in one power control group (PCG) for the I/Q waveforms. The range is 0 to 1535 chips.
- **Chip Interval** - Allows you to specify the number of chips to be displayed from the offset chip specified by **Chip Offset**. The range is 1,

Making Measurements

or the number of chips specified by **Chip Offset**, to 1536 chips.

- **+45 deg Rot** - Allows you to toggle the display rotation function between **On** and **Off**. If this is set to **On**, the I/Q polar vector or constellation graph is rotated by +45 degrees to see a rectangular display. The default setting is **Off**. This key does not affect the **I/Q Error (Quad View)** display.
- **Full Vector (Background)** - Allows you to toggle the full vector display function between **On** and **Off**. If set to **On**, the full vector traces in gray color are displayed in the background of the polar vector solid traces in yellow. The default setting is **Off**. If **View/Trace** is set to **I/Q Measured Polar Constln**, this key is grayed out. This key does not affect the **I/Q Error (Quad View)** display.

If the Power Timing & Phase window is active in the **Power Timing & Phase** view, the **Display** key accesses the menu to allow the following controls to read the measurement results:

- **Prev Page** - Returns to the previous page of the measurement results.
- **Next Page** - Moves to the next page of the measurement results.
- **Scroll Up** - Moves one line upward on the current page of the measurement results each time it is pressed.
- **Scroll Down** - Moves one line downward on the current page of the measurement results each time it is pressed.
- **First Page** - Moves from the current page to the first page of the measurement results.
- **Last Page** - Moves from the current page to the last page of the measurement results.

If either EVM, Phase Error, or Mag Error window is active in the **I/Q Error (Quad-View)** view, the **SPAN X Scale** key accesses the menu to allow the following settings:

- **Scale/Div** - Allows you to set the horizontal scale by changing a chip value per division. The range is 1.000 to 500000.0 chips per division with 0.001 chip resolution. The default setting is 152.7 chips per division. However, since the **Scale Coupling** default **On**, this value is automatically determined by the measurement result. When you set a value manually, **Scale Coupling** automatically changes to **Off**.
- **Ref Value** - Allows you to set the chip reference value ranging from 0.000 to 5000000.0 chips. The default setting is 0.000 chip. However, since the **Scale Coupling** default is **On**, this value is automatically determined by the measurement results. When you set a value manually, **Scale Coupling** automatically changes to **Off**.
- **Ref Position** - Allows you to set the reference position to either **Left**, **Ctr** (center) or **Right**. The default setting is **Left**.

- **Scale Coupling** - Allows you to toggle the scale coupling function between **On** and **Off**. The default setting is **On**. Upon pressing the **Restart** front-panel key or the **Restart** softkey under the **Meas Control** menu, scale coupling automatically determines the scale per division and reference values based on the measurement results. When you set a value to either **Scale/Div** or **Ref Value** manually, **Scale Coupling** automatically changes to **Off**.

If either EVM or Mag Error window is active in the **I/Q Error (Quad-View)** view, the **AMPLITUDE Y Scale** key accesses the menu to allow the following settings:

- **Scale/Div** - Allows you to set the vertical scale by changing the value per division. The range is 0.100 to 50.0% per division. The default setting is 5.00%. However, since the **Scale Coupling** default is **On**, this value is automatically determined by the measurement result. When you set a value manually, **Scale Coupling** automatically changes to **Off**.
- **Ref Value** - Allows you to set the reference value ranging from 0.00 to 500.0%. The default setting is 0.00%. However, since the **Scale Coupling** default is **On**, this value is automatically determined by the measurement results. When you set a value manually, **Scale Coupling** automatically changes to **Off**.
- **Ref Position** - Allows you to set the reference position to either **Top**, **Ctr** (center) or **Bot** (bottom). For the EVM graph, the default setting is **Bot**. For the Mag Error graph, the default setting is **Ctr**.
- **Scale Coupling** - Allows you to toggle the scale coupling function between **On** and **Off**. The default setting is **On**. Upon pressing the **Restart** front-panel key or the **Restart** softkey under the **Meas Control** menu, scale coupling automatically determines the scale per division and reference values based on the measurement results. When you set a value to either **Scale/Div** or **Ref Value** manually, **Scale Coupling** automatically changes to **Off**.

If the Phase Error window is active in the **I/Q Error (Quad-View)** view, the **AMPLITUDE Y Scale** key accesses the menu to allow the following settings:

- **Scale/Div** - Allows you to set the vertical scale by changing the value per division. The range is 0.01 to 3600.0 degrees. The default setting is 5.00 degrees per division. However, since the **Scale Coupling** default is **On**, this value is automatically determined by the measurement result. When you set a value manually, **Scale Coupling** automatically changes to **Off**.
- **Ref Value** - Allows you to set the reference value ranging from -36000 to 36000 degrees. The default setting is 0.00 degrees. However, since the **Scale Coupling** default is **On**, this value is automatically determined by the measurement results. When you set a value

manually, **Scale Coupling** automatically changes to **Off**.

- **Ref Position** - Allows you to set the reference position to either **Top**, **Ctr** (center) or **Bot** (bottom). The default setting is **Ctr**.
- **Scale Coupling** - Allows you to toggle the scale coupling function between **On** and **Off**. The default setting is **On**. Upon pressing the **Restart** front-panel key or the **Restart** softkey under the **Meas Control** menu, scale coupling automatically determines the scale per division and reference values based on the measurement results. When you set a value to either **Scale/Div** or **Ref Value** manually, **Scale Coupling** automatically changes to **Off**.

## Using the Markers

The **Marker** front-panel key accesses the menu to configure the markers depending on the display selected.

- **Select** - Allows you to activate up to four markers with the corresponding numbers, respectively. The selected number is underlined and its function is defined by pressing the **Function** key. The default setting is 1.
- **Normal** - Allows you to activate the selected marker to read the magnitude or phase error and the number of chips of the marker position on the selected trace, for example. Marker position is controlled by the RPG knob.
- **Delta** - Allows you to read the differences in the magnitude or phase errors and the number of chips between the selected marker and the next.
- **Function** - Allows you to set the selected marker function to **Band Power**, **Noise**, or **Off**. The default setting is **Off**. The **Band Power** and **Noise** functions are not available for this measurement.
- **Trace** - Allows you to place the selected marker on the **EVM**, **Phase Error**, or **Mag Error** trace. The default setting is **EVM**.
- **Off** - Allows you to turn off the selected marker.
- **Shape** - Allows you to access the menu to set the selected marker shape to **Diamond**, **Line**, **Square**, or **Cross**. The default setting is **Diamond**.
- **Marker All Off** - Allows you to turn off all of the markers.

## Troubleshooting Hints

A poor phase error often indicates a problem with the I/Q baseband generator, filters, and/or modulator in the transmitter circuitry of the UUT. The output amplifier in the transmitter can also create distortion that causes unacceptably high phase error. In a real system, a poor

phase error will reduce the ability of a receiver to correctly demodulate the received signal, especially in marginal signal conditions.

---

## Making the QPSK EVM Measurement

### Purpose

Phase and frequency errors are measures of modulation quality for the cdma2000 system. This modulation quality is obtained through QPSK Error Vector Magnitude (EVM) measurements. Since the cdma2000 system uses Quadrature Phase Shift Keying (QPSK) modulation, the phase and frequency accuracies of the transmitter are critical to the communications system performance and ultimately affect range.

cdma2000 receivers rely on the phase and frequency quality of the QPSK modulation signal in order to achieve the expected carrier to noise ratio. A transmitter with high phase and frequency errors will often still be able to support phone calls during a functional test. However, it will tend to cause difficulty for mobiles trying to maintain service at the edge of the cell with low signal levels or under difficult fading and Doppler conditions.

### Measurement Method

The input signal needs to be a single coded signal, such as a pilot channel. The phase error of the unit under test is measured by computing the difference between the phase of the transmitted signal and the phase of a theoretically perfect signal.

The instrument samples the transmitter output in order to capture the actual phase trajectory. This is then demodulated and the ideal phase trajectory is mathematically derived using detected bits and channel filtering. Subtracting one from the other results in a phase error signal.

This measurement allows you to display these errors numerically and graphically on the instrument display. There are graphs for EVM, Phase Error and Mag Error in the graph windows. In the text window, there are both maximum and average data for Evm: in % rms, in % peak, RMS Mag Error: in %, Phase Error: in degrees, Freq Error: in Hz, and IQ Offset: in dB.

For E4406A Option B7C, this measurement is available for use with either the RF input or Baseband I/Q inputs. For detailed operation, see [“Using Option B7C Baseband I/Q Inputs” on page 238](#).

### Making the Measurement

---

**NOTE**

The factory default settings provide a cdma2000 compliant measurement. For special requirements, you may need to change some of the settings. Press **Meas Setup, More, Restore Meas Defaults** at any time to return all parameters for the current measurement to their

default settings.

Select the desired center frequency as described in “Changing the Frequency Channel” on page 83.

For PSA, if Option 1DS Internal Preamplifier is installed, it will be available for this measurement. See “Configuring the Input Condition” on page 75 for details of **Int Preamp** and **Attenuator** operation.

Press **MEASURE, QPSK EVM** to immediately make a QPSK error vector magnitude (EVM) measurement.

To change any of the measurement parameters from the factory default values, refer to “Changing the Measurement Setup” on page 200.

For E4406A Option B7C, this measurement is available for use with either the RF input or Baseband I/Q inputs. For detailed operation, see “Using Option B7C Baseband I/Q Inputs” on page 238.

## Results

The following figure shows an example result of I/Q Measured Polar Vector for the QPSK EVM measurements in the graph window. The maximum and average measured data such as rms and peak EVM, magnitude error, phase error, frequency error, and so forth are shown in the text window.

Figure 4-17

### QPSK EVM Measurement - I/Q Polar Vector View

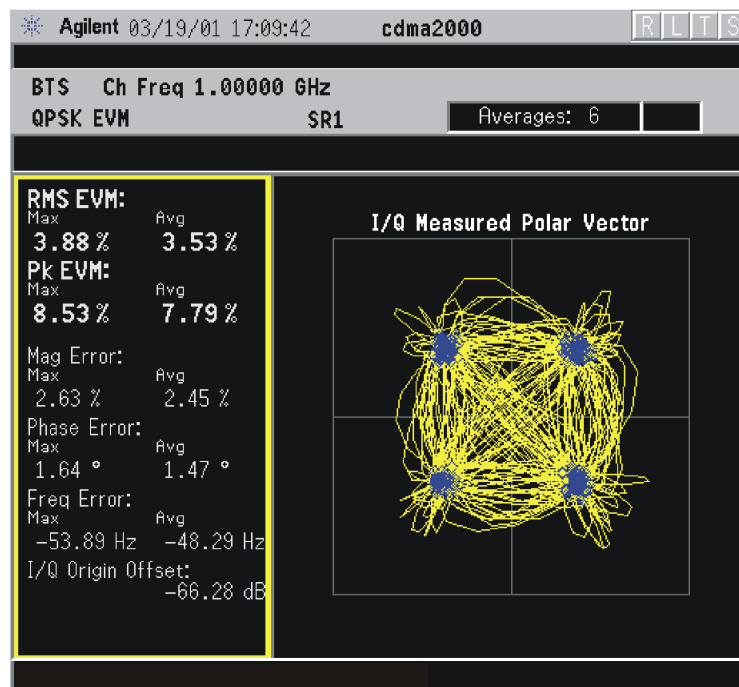

\*Meas Setup: Factory default settings

\*Input signal: -10.00 dBm, Pilot channel of SR1, cdma2000 Rev 8

## Changing the Measurement Setup

This table shows the factory default settings for QPSK EVM measurements.

**Table 4-15 QPSK EVM Measurement Defaults**

Measurement Parameter	Factory Default Condition
View/Trace	I/Q Measured Polar Vector
Display:	
I/Q Points	1280
Chip Dots	On
Meas Setup:	
Avg Number	10; On
Avg Mode	Repeat
Meas Interval	256 chips
Trig Source	Free Run (Immediate)
<b>Advanced</b>	
Chip Rate:	1.22880 MHz (for SR1)
ADC Range	-6 dB (for E4406A), None (for PSA)

Make sure the **QPSK EVM** measurement is selected under the **MEASURE** menu. Press the **Meas Setup** key to access a menu which allows you to modify the average number, average mode, and trigger source as described in “[Measurement Setup](#)” on page 127.

In addition, the following QPSK error vector magnitude measurement parameters can be modified.

- **Meas Interval** - Allows you to set the time interval over which the measurement is made. The range is 128 to 1536 chips.
- **Advanced** - Allows you to access the menu to change the following parameters:
  - **Chip Rate** - Allows you to change the chip rate. The range is 1.10592 to 1.35168 MHz for SR1.
  - **ADC Range** - Allows you to access the following selection menu to define one of the ADC ranging functions:
    - Auto Peak** - Select this to set the ADC range automatically to the peak signal level. **Auto Peak** is a compromise that works well for both CW and burst signals.
    - Auto** - Select this to set the ADC range automatically. For most



FFT measurements, the auto feature should not be selected. An exception is when measuring a “bursty” signal, in which case **Auto** can maximize the time domain dynamic range, if FFT results are less important to you than time domain results.

- ❑ **Auto Peak Lock** - Select this to hold the ADC range automatically at the peak signal level. **Auto Peak Lock** is more stable than **Auto Peak** for CW signals, but should not be used for “bursty” signals.
- ❑ **Manual** - Allows you to access the selection menu of values, -6 to +24 dB for E4406A or None to +18 dB for PSA, to set the ADC range level. Also note that manual ranging is best for CW signals.

## Changing the View

The **View/Trace** key will allow you to select the desired view of the measurement from the following:

- **I/Q Measured Polar Vector** - Provides a combination view of an I/Q measured polar vector graph and the maximum and average summary data as shown in [Figure 4-17 on page 199](#).
- **I/Q Measured Polar ConstIn** - Provides a combination view of an I/Q measured polar constellation graph and the maximum and average summary data for the rms EVM, peak EVM, magnitude error, phase error, frequency error, and so forth in the text window as shown in [Figure 4-18 on page 202](#).

Figure 4-18 QPSK EVM Measurement - I/Q Polar Constellation View

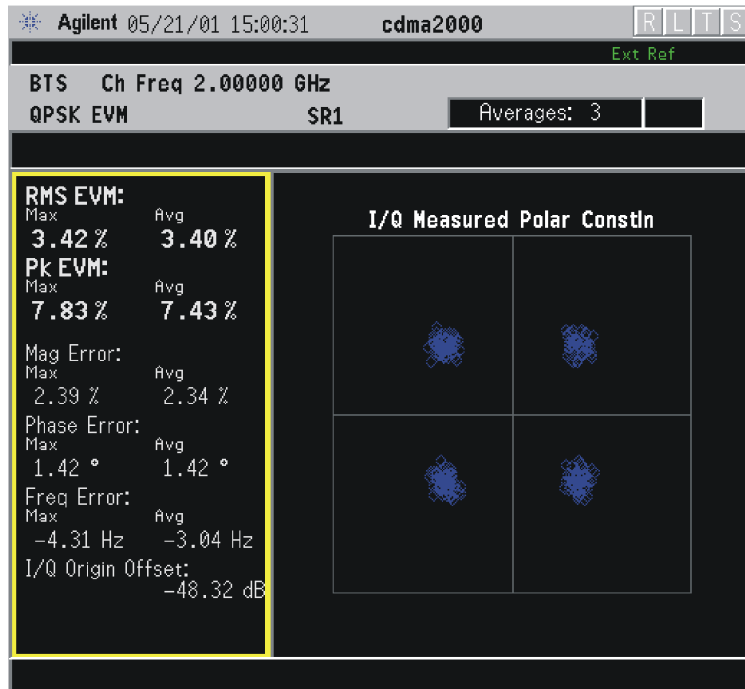

\*Meas Setup: View/Trace = I/Q Measured Polar Constn,  
Others = Factory default settings

\*Input signal: -10.00 dBm, Pilot channel of SR1, cdma2000 Rev 8

- **I/Q Error (Quad-View)** - Four display windows show Mag Error, Phase Error and EVM graphs and the maximum and average summary data for the rms EVM, peak EVM, magnitude error, phase error, frequency error, and so forth in the text window as shown in [Figure 4-19](#).

**Figure 4-19 QPSK EVM Measurement - I/Q Error Quad View**

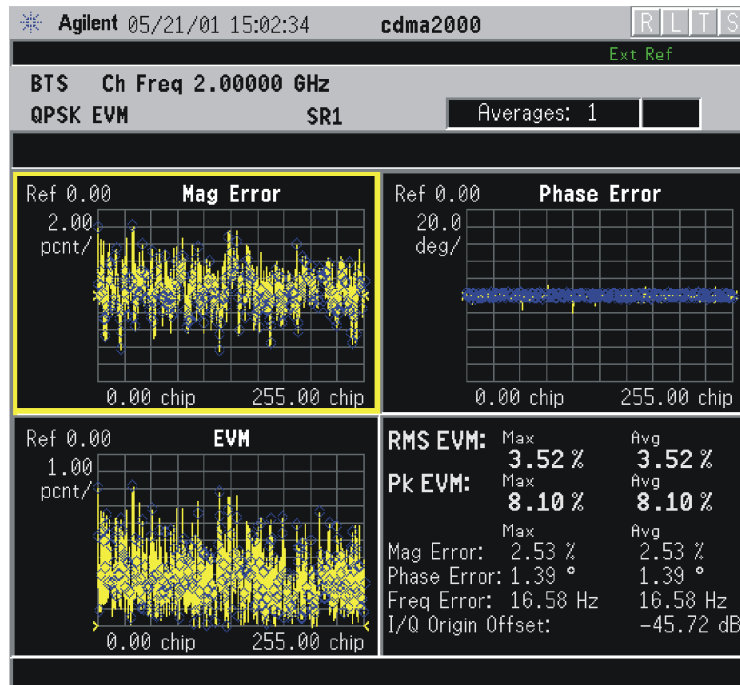

\*Meas Setup: View/Trace = I/Q Error (Quad View),  
Others = Factory default settings

\*Input signal: -10.00 dBm, Pilot channel of SR1, cdma2000 Rev 8

Any of these windows can be selected using the **Next Window** key and made full size using the **Zoom** key.

## Changing the Display

The **Display** key accesses the menu to allow the following selections for changing the graph displays of I/Q Measured Polar Vector, I/Q Measured Constln, and I/Q Error (Quad View):

- **I/Q Points** - Allows you to specify the number of displayed points for the I/Q waveforms. The range is 1 to 2560 points with the points per chip fixed at 5, depending on the **Meas Interval** setting. This key has no affect on the **I/Q Error (Quad View)** display.
- **Chip Dots** - Allows you to toggle the chip dot display between **On** and **Off**. If set to **On**, the chip dots in yellow are overlaid on the I/Q polar graph. If **View/Trace** is set to **I/Q Measured Polar Constln**, this key is grayed out.

If either EVM, Phase Error, or Mag Error window is active in the **I/Q Error (Quad-View)** view, the **SPAN X Scale** key accesses the menu to allow the following settings:

- **Scale/Div** - Allows you to set the horizontal scale by changing a chip value per division. The range is 1.00 to 500000.0 chips per division.

The default setting is 25.50 chips per division. However, since the **Scale Coupling** default is **On**, this value is automatically determined by the measurement result. When you set a value manually, **Scale Coupling** automatically changes to **Off**.

- **Ref Value** - Allows you to set the chip reference value ranging from 0.000 to 5000000.0 chips. The default setting is 0.000 chip. However, since the **Scale Coupling** default is **On**, this value is automatically determined by the measurement results. When you set a value manually, **Scale Coupling** automatically changes to **Off**.
- **Ref Position** - Allows you to set the reference position to either **Left**, **Ctr** (center) or **Right**. The default setting is **Left**.
- **Scale Coupling** - Allows you to toggle the scale coupling function between **On** and **Off**. The default setting is **On**. Upon pressing the **Restart** front-panel key or the **Restart** softkey under the **Meas Control** menu, scale coupling automatically determines the scale per division and reference values based on the measurement results. When you set a value to either **Scale/Div** or **Ref Value** manually, **Scale Coupling** automatically changes to **Off**.

If either EVM or Mag Error window is active in the **I/Q Error (Quad-View)** view, the **AMPLITUDE Y Scale** key accesses the menu to allow the following settings:

- **Scale/Div** - Allows you to set the vertical scale by changing the value per division. The range is 0.100 to 50.0% per division. The default setting is 5.00%. However, since the **Scale Coupling** default is **On**, this value is automatically determined by the measurement result. When you set a value manually, **Scale Coupling** automatically changes to **Off**.
- **Ref Value** - Allows you to set the reference value ranging from 0.00 to 500.0%. The default setting is 0.00%. However, since the **Scale Coupling** default is **On**, this value is automatically determined by the measurement results. When you set a value manually, **Scale Coupling** automatically changes to **Off**.
- **Ref Position** - Allows you to set the reference position to either **Top**, **Ctr** (center) or **Bot** (bottom). For the EVM graph, the default setting is **Bot**. For the Mag Error graph, the default setting is **Ctr**.
- **Scale Coupling** - Allows you to toggle the scale coupling function between **On** and **Off**. The default setting is **On**. Upon pressing the **Restart** front-panel key or the **Restart** softkey under the **Meas Control** menu, scale coupling automatically determines the scale per division and reference values based on the measurement results. When you set a value to either **Scale/Div** or **Ref Value** manually, **Scale Coupling** automatically changes to **Off**.

When the Phase Error window is active in the **I/Q Error (Quad-View)** display, the **AMPLITUDE Y Scale** key accesses the menu to allow the

following settings:

- **Scale/Div** - Allows you to set the vertical scale by changing the value per division. The range is 0.01 to 3600 degrees. The default setting is 0.10 degrees per division. However, since the **Scale Coupling** default is **On**, this value is automatically determined by the measurement result. When you set a value manually, **Scale Coupling** automatically changes to **Off**.
- **Ref Value** - Allows you to set the reference value ranging from -36000 to 36000 degrees. The default setting is 0.00 degrees. However, since the **Scale Coupling** default is **On**, this value is automatically determined by the measurement results. When you set a value manually, **Scale Coupling** automatically changes to **Off**.
- **Ref Position** - Allows you to set the reference position to either **Top**, **Ctr** (center) or **Bot** (bottom). The default setting is **Ctr**.
- **Scale Coupling** - Allows you to toggle the scale coupling function between **On** and **Off**. The default setting is **On**. Upon pressing the **Restart** front-panel key or the **Restart** softkey under the **Meas Control** menu, scale coupling automatically determines the scale per division and reference values based on the measurement results. When you set a value to either **Scale/Div** or **Ref Value** manually, **Scale Coupling** automatically changes to **Off**.

## Using the Markers

The **Marker** front-panel key accesses the menu to configure the markers depending on the display selected.

- **Select** - Allows you to activate up to four markers with the corresponding numbers, respectively. The selected number is underlined and its function is defined by pressing the **Function** key. The default setting is 1.
- **Normal** - Allows you to activate the selected marker to read the magnitude or phase error and the number of chips of the marker position on the selected trace, for example. Marker position is controlled by the RPG knob.
- **Delta** - Allows you to read the differences in the magnitude or phase errors and the number of chips between the selected marker and the next.
- **Function** - Allows you to set the selected marker function to **Band Power**, **Noise**, or **Off**. The default setting is **Off**. The **Band Power** and **Noise** functions are not available for this measurement.
- **Trace** - Allows you to place the selected marker on the **EVM**, **Phase Error**, or **Mag Error** trace. The default setting is **EVM**.
- **Off** - Allows you to turn off the selected marker.

- **Shape** - Allows you to access the menu to set the selected marker shape to **Diamond**, **Line**, **Square**, or **Cross**. The default setting is **Diamond**.
- **Marker All Off** - Allows you to turn off all of the markers.

## Troubleshooting Hints

A poor phase error indicates a problem with the I/Q baseband generator, filters, and/or modulator in the transmitter circuitry of the UUT. The output amplifier in the transmitter can also create distortion that causes unacceptably high phase error. In a real system, a poor phase error will reduce the ability of a receiver to correctly demodulate the received signal, especially in marginal signal conditions.

---

## Making the Power Stat CCDF Measurement

### Purpose

Many of the digitally modulated signals now look noise-like in the time and frequency domain. This means that statistical measurements of the signals can be a useful characterization. Power Complementary Cumulative Distribution Function (CCDF) curves characterize the higher-level power statistics of a digitally-modulated signal. The curves can be useful in determining design parameters for digital communications systems.

The power statistics CCDF measurement can be affected by many factors. For example, modulation filtering, modulation format, combining the multiple signals at different frequencies, number of active codes and correlation between symbols on different codes with spread spectrum systems. These factors are all related to modulation and signal parameters. External factors such as signal compression and expansion by non-linear components, group delay distortion from filtering, and power control within the observation interval also affect the measurement.

### Measurement Method

The power measured in power statistics CCDF curves is actually instantaneous envelope power defined by the equation:

$$P = (I^2 + Q^2)/Z_0$$

(where I and Q are the quadrature voltage components of the waveform and  $Z_0$  is the characteristic impedance).

A CCDF curve is defined by how much time the waveform spends at or above a given power level. The percent of time the signal spends at or above the level defines the probability for that particular power level. To make the power statistics CCDF measurement, the instrument uses digital signal processing (DSP) to sample the input signal in the channel bandwidth.

The Gaussian distribution line as the band-limited gaussian noise CCDF reference line, the user-definable reference trace, and the currently measured trace can be displayed on a semi-log graph. If the currently measured trace is above the user reference trace, it means that the higher peak power levels against the average power are included in the input signal.

For E4406A Option B7C, this measurement is available for use with either the RF input or Baseband I/Q inputs. For detailed operation, see [“Using Option B7C Baseband I/Q Inputs” on page 238](#).

## Making the Measurement

**NOTE** The factory default settings provide a cdma2000 compliant measurement. For special requirements, you may need to change some of the settings. Press **Meas Setup, More, Restore Meas Defaults** at any time to return all parameters for the current measurement to their default settings.

Select the desired center frequency as described in “[Changing the Frequency Channel](#)” on page 83.

Press **MEASURE, Power Stat CCDF** to immediately make a power statistics CCDF measurement.

To change any of the measurement parameters from the factory default values, refer to “[Changing the Measurement Setup](#)” on page 209.

## Results

The following figure [Figure 4-20](#) shows an example result of Power Stat CCDF measurements in the graph window. The average power and its probability are shown in the text window.

**Figure 4-20** Power Statistics CCDF Measurement

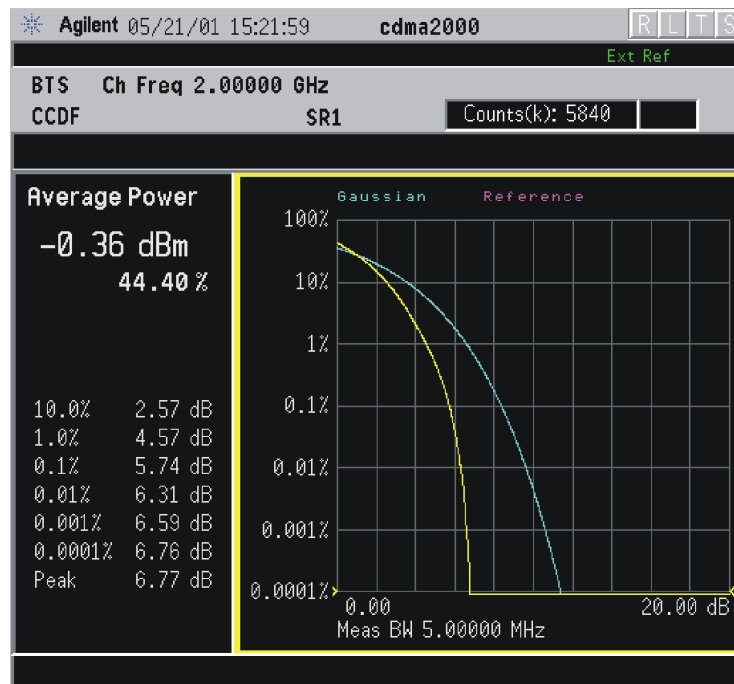

\*Meas Setup: Factory default settings

\*Input signal: 0.00 dBm, Pilot channel of SR1, cdma2000 Rev 8



## Changing the Measurement Setup

The next table shows the factory default settings for power statistics CCDF measurements.

**Table 4-16** Power Statistics CCDF Measurement Defaults

Measurement Parameter	Factory Default Condition
Meas Setup:	
Meas BW	5.00000 MHz
Counts	10.0000 Mpoints
Meas Interval	1.000 ms
Trig Source	Free Run (Immediate)
Meas Control:	
Measure	Single
Display:	
Ref Trace	Off
Gaussian Line	On

Make sure the **Power Stat CCDF** measurement is selected under the **MEASURE** menu. Press the **Meas Setup** key to access the menu which allows you to modify the trigger source for this measurement as described in [“Measurement Setup” on page 127](#).

In addition, the following parameters can be modified.

- **Meas BW** - Allows you to set the measurement bandwidth according to the channel bandwidth. The range is 10.000 kHz to 6.70000 MHz with 0.1 kHz resolution.
- **Counts** - Allows you to set the accumulated number of sampling points for data acquisition. The range is 1.000 kpoints to 2.000 Gpoints with 1 or 10 kpoints resolution. While this key is activated, enter a value from the numeric keypad by terminating with one of the unit keys shown.
- **Meas Interval** - Allows you to specify the time interval over which the measurement is made. The range is 100.0  $\mu$ s to 10.00 ms with 1  $\mu$ s resolution.

## Changing the View

The **View /Trace** key is not available for this measurement.

## Changing the Display

The **Display** key allows you to control the desired trace and line displays of the power statistics CCDF curves. The currently measured curve is always shown.

- **Store Ref Trace** - Allows you to copy the currently measured curve as the user-definable reference trace. The captured data will remain until the other mode is chosen. Pressing this key refreshes the reference trace.
- **Ref Trace** - Allows you to toggle the reference trace display function between **On** and **Off**.
- **Gaussian Line** - Allows you to toggle the Gaussian line display function between **On** and **Off**.

The **SPAN X Scale** key accesses the menu to set the desired horizontal scale.

- **Scale/Div** - Allows you to enter a numeric value to change the horizontal display sensitivity. The range is 0.10 to 20.00 dB with 0.01 dB resolution. The default setting is 2.00 dB.

## Using the Markers

The **Marker** front-panel key accesses the menu to configure the markers.

- **Select** - Allows you to activate up to four markers with the corresponding numbers, respectively. The selected number is underlined and its function is defined by pressing the **Function** key. The default selection is 1.
- **Normal** - Allows you to activate the selected marker to read the power level and probability of the marker position on the selected curve. Marker position is controlled by the RPG knob.
- **Delta** - Allows you to read the differences in the power levels and probabilities between the selected marker and the next.
- **Function** - Allows you to set the selected marker function to **Band Power**, **Noise**, or **Off**. The default setting is **Off**. The **Band Power** and **Noise** functions are not available for this measurement.
- **Trace** - Allows you to place the selected marker on the **Measured**, **Gaussian**, or **Reference** curve. The default setting is **Measured**.
- **Off** - Allows you to turn off the selected marker.
- **Shape** - Allows you to access the menu to set the selected marker shape to **Diamond**, **Line**, **Square**, or **Cross**. The default setting is **Diamond**.
- **Marker All Off** - Allows you to turn off all of the markers.

## Troubleshooting Hints

The power statistics CCDF measurement can help in determining the signal power specifications used as design criteria for systems, amplifiers, and other components. For example, it can help determine the optimum operating point to adjust code timing for appropriate peak/average power ratio throughout the wide channel bandwidth of the transmitter for a cdma2000 system.

As this measurement becomes more widely used the correlation between CCDF curve degradation and digital radio system measurement parameters such as BER, FER, code domain power, and ACPR will become more established. Further studies will eventually yield standards for radio design by specifying the maximum allowed CCDF curve degradation for specific systems.

---

## Making the Spectrum (Frequency Domain) Measurement

### Purpose

The spectrum measurement provides spectrum analysis capability for the instrument. The control of the measurement was designed to be familiar to those who are accustomed to using swept spectrum analyzers.

This measurement is FFT (Fast Fourier Transform) based. The FFT-specific parameters are located in the **Advanced** menu. Also available under basic mode spectrum measurements is an I/Q window, which shows the I and Q signal waveforms in parameters of voltage versus time. The advantage of having an I/Q view available while in the spectrum measurement is that it allows you to view complex components of the same signal without changing settings or measurements.

### Measurement Method

The measurement uses digital signal processing to sample the input signal and convert it to the frequency domain. With the instrument tuned to a fixed center frequency, samples are digitized at a high rate, converted to I and Q components with DSP hardware, and then converted to the frequency domain with FFT software.

For E4406A Option B7C, this measurement is available for both the RF input and baseband I/Q inputs. For details on Baseband I/Q operation see the section on [“Using Option B7C Baseband I/Q Inputs”](#).

### Making the Measurement

---

**NOTE**

The factory default parameters provide a good starting point. You will likely want to change some of the settings. Press **Meas Setup, More, Restore Meas Defaults** at any time to return all parameters for the current measurement to their default settings.

Press **MEASURE, Spectrum (Freq Domain)** to immediately make a spectrum measurement.

To change any of the measurement parameters from the factory default values, refer to the “Changing the Measurement Setup” section for this measurement.

For E4406A Option B7C, when using the baseband I/Q inputs, set **Input Port** to **I/Q**, configure the **I/Q Setup** parameters, and supply the baseband

I/Q signals to the front-panel I/Q inputs. The available trigger sources for this measurement includes **I/Q Level**.

## Results

A display with both a Spectrum window and an I/Q Waveform window will appear when you activate a spectrum measurement. Use the **Next Window** key to select a window, and the **Zoom** key to enlarge a window.

**Figure 4-21**

**Spectrum Measurement - Spectrum and I/Q Waveform View**

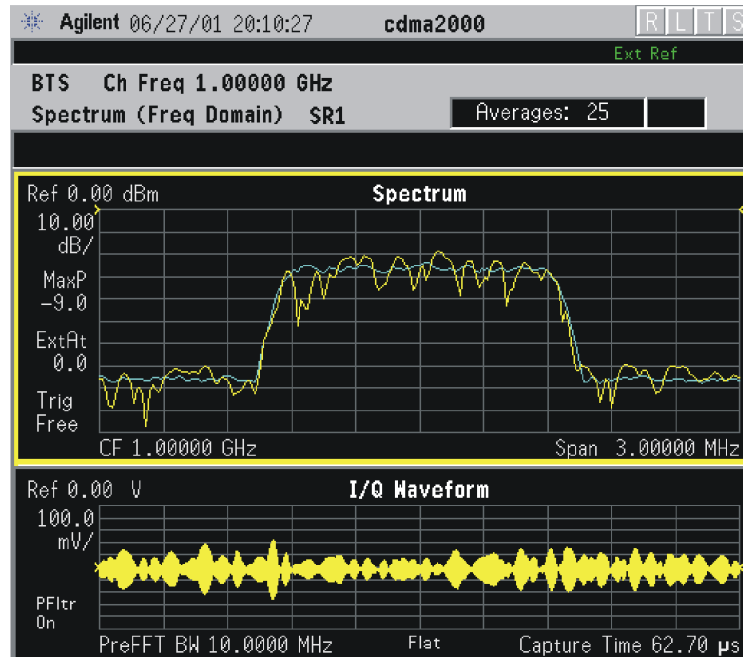

\*Meas Setup: Span = 3.000 MHz, Capture Time = 62.70 μs,  
 Others = Factory default settings

\*Input signal: -10.00 dBm, Pilot channel of SR1, cdma2000 Rev 8

## Changing the Measurement Setup

The following table shows the factory default settings for spectrum (frequency domain) measurements.

**Table 4-17**

**Spectrum (Frequency Domain) Measurement Defaults**

Measurement Parameter	Factory Default Condition
View/Trace	Spectrum
Trace Display	All
Res BW	20.0000 kHz; Auto

Table 4-17 Spectrum (Frequency Domain) Measurement Defaults

Measurement Parameter	Factory Default Condition
Averaging: Avg Number Avg Mode Avg Type	25; On Exp Log-Pwr Avg (Video)
Trig Source	Free Run (Immediate)
<b>Spectrum View:</b> SPAN AMPLITUDE Y Scale - Scale/Div	1.00000 MHz 10.00 dB
<b>I/Q Waveform View:</b> Capture Time AMPLITUDE Y Scale - Scale/Div	188.00 $\mu$ s 100.0 mV
<b>Spectrum Linear View:</b> SPAN AMPLITUDE Y Scale - Scale/Div	<b>(for E4406A)</b> 1.00000 MHz 100.0 mV
<b>I and Q Waveform View:</b> Capture Time AMPLITUDE Y Scale - Scale/Div	<b>(for E4406A)</b> 188.00 $\mu$ s 100.0 mV
<b>I/Q Polar View:</b> I/Q Scale/Div I or Q Origin	<b>(for E4406A)</b> 100.0 mV 0.00 V
<b>Advanced</b>	
Pre-ADC BPF	On
Pre-FFT Filter	Flat
Pre-FFT BW	1.55000 MHz; Auto
FFT Window	Flat Top (High Amptd Acc)
FFT Size: Length Control Min Points/RBW Window Length FFT Length	Auto 3.100000 706 1024
ADC Range	Auto Peak
Data Packing	Auto
ADC Dither	Auto
Decimation	0; Auto
IF Flatness	On

**NOTE** Parameters under the **Advanced** key seldom need to be changed. Any

changes from the default advanced values may result in invalid measurement data.

Make sure the **Spectrum (Freq Domain)** measurement is selected under the **MEASURE** menu. Press the **Meas Setup** key to access a menu which allows you to modify the averaging and trigger source for this measurement (as described in the “Measurement Setup” section). In addition, the following parameters can be modified:

- **Span** - Allows you to modify the frequency span. The range is 10.000 Hz to 10.000 MHz with 1 Hz resolution, depending on the **Res BW** setting. Changing the span causes the resolution bandwidth to change automatically, and will affect data acquisition time.
- **Res BW** - Allows you to set the resolution bandwidth for the FFT, and to toggle its mode between **Auto** and **Man** (manual). If set to **Auto**, the resolution bandwidth is set to **Span/50** (2% of the span). If set to **Man**, you can enter a value ranging from 100.0 mHz to 3.00000 MHz. A narrower bandwidth will result in a longer data acquisition time.
- **Advanced** - Allows you to access the menu to change the following parameters. The FFT advanced features should be used only if you are familiar with their operation. Changes from the default values may result in invalid data.
  - **Pre-ADC BPF** - Allows you to toggle the pre-ADC bandpass filter function between **On** and **Off**. The pre-ADC bandpass filter is useful for rejecting nearby signals, so that sensitivity within the span range can be improved by increasing the ADC range gain.
  - **Pre-FFT Fitr** - Allows you to toggle the pre-FFT filter between **Flat** (flat top) and **Gaussian**. The pre-FFT filter defaults to a flat top filter which has better amplitude accuracy. The Gaussian filter has better pulse response.
  - **Pre-FFT BW** - Allows you to toggle the pre-FFT bandwidth function between **Auto** and **Man** (manual). The pre-FFT bandwidth filter can be set between 1 Hz and 10 MHz. If set to **Auto**, this pre-FFT bandwidth is nominally 50% wider than the span. This bandwidth determines the ADC sampling rate.
  - **FFT Window** - Allows you to access the following selection menu. Unless you are familiar with FFT windows, use the flat top filter (the default filter).
    - Flat Top** - Selects this filter for best amplitude accuracy by reducing scalloping error.
    - Uniform** - Select this filter to have no window active by using the uniform setting.
    - Hanning** - Press this key to activate the Hanning filter.
    - Hamming** - Press this key to activate the Hamming filter.

- Gaussian** - Press this key to activate the Gaussian filter with the roll-off factor (alpha) of 3.5.
  - Blackman** - Press this key to activate the Blackman filter.
  - Blackman Harris** - Press this key to activate the Blackman Harris filter.
  - K-B 70dB/90dB/110dB (Kaiser-Bessel)** - Select one of the Kaiser-Bessel filters with sidelobes at -70, -90, or -110 dBc.
- **FFT Size** - Allows you to access the menu to change the following parameters:
- Length Ctrl** - Allows you to toggle the FFT and window length setting function between **Auto** and **Man** (manual).
  - Min Pts in RBW** - Allows you to set the minimum number of data points that will be used inside the resolution bandwidth. The range is 0.10 to 100.00 points with 0.01 resolution. This key is grayed out if **Length Ctrl** is set to **Man**.
  - Window Length** - Allows you to enter the FFT window length in the number of capture samples, ranging from 8 to 1048576. This length represents the actual quantity of I/Q samples that are captured for processing by the FFT (“Capture Time” is the associated parameter shown on the screen). This key is grayed out if **Length Control** is set to **Auto**.
  - FFT Length** - Allows you to enter the FFT length in the number of captured samples, ranging from 8 to 1048576. The FFT length setting is automatically limited so that it is equal to or greater than the FFT window length setting. Any amount greater than the window length is implemented by zero-padding. This key is grayed out if **Length Control** is set to **Auto**.
- **ADC Range** - Allows you to access the menu to define one of the following ADC ranging functions:
- Auto** - Select this to set the ADC range automatically. For most FFT spectrum measurements, the auto feature should not be selected. An exception is when measuring a signal which is “bursty”, in which case auto can maximize the time domain dynamic range, if FFT results are less important to you than time domain results.
  - Auto Peak** - Select this to set the ADC range automatically to the peak signal level. Auto peak is a compromise that works well for both CW and burst signals.
  - Auto Peak Lock** - Select this to hold the ADC range automatically at the peak signal level. Auto peak lock is more stable than auto peak for CW signals, but should not be used



for “bursty” signals.

- Manual** - Allows you to access the selection menu of values, -6 to +24 dB for E4406A or None to +18 dB for PSA, to set the ADC range level. Also note that manual ranging is best for CW signals.
- **Data Packing** - Allows you to select **Auto** (the default) or the **Short (16 bit)**, **Medium (24 bit)** and **Long (32 bit)** methods of data packing. The short, medium, and long methods are not compatible with all settings and should not be used unless you are familiar with data packing methods. **Auto** is the preferred choice.
  - Auto** - The data packing value most appropriate for current instrument settings is selected automatically.
  - Short (16 bit)** - Select this to pack data every 16 bits.
  - Medium (24 bit)** - Select this to pack data every 24 bits.
  - Long (32 bit)** - Select this to pack data every 32 bits.
- **ADC Dither** - Allows you to toggle the ADC dither function between **Auto**, **On**, and **Off**. When set to **Auto** (the default), the ADC dither function will be activated when a narrow bandwidth is being measured, and deactivated when a wide bandwidth is being measured. “ADC dither” refers to the introduction of noise to the digitized steps of the analog-to-digital converter; the result is an improvement in amplitude accuracy. Use of the ADC dither, however, reduces dynamic range by approximately 3 dB.
- **Decimation** - Allows you to toggle the decimation function between **Auto** and **Man**, and to set the decimation value. **Auto** is the preferred setting, and the only setting that guarantees alias-free FFT spectrum measurements. If you are familiar with the decimation feature, you can change the decimation value by setting to **Man**, but be aware that aliasing can result in higher values. Decimation numbers 1 to 1000 describe the factor by which the number of points are reduced. The default setting is 0, which results in no data point reduction. Decimation by 3 keeps every 3rd sample, throwing away the 2 in between.
- **IF Flatness** - Allows you to toggle the IF flatness function between **On** and **Off**. If set to **On** (the default), the IF flatness feature causes background amplitude corrections to be performed on the FFT spectrum. The **Off** setting is used for adjustment and troubleshooting of the test instrument.

## Changing the View

The View/Trace key allows you to select the desired view of the measurement from the following. You can use the Next Window key to move between the multiple windows (if any) and make it full size by

Zoom.

- **Spectrum** - Provides a combination view of the spectrum graph in parameters of power versus frequency with the semi-log graticules, and the I/Q waveform graph in the parameters of voltage and time. Changes to frequency span or power will sometimes affect data acquisition.
- **I/Q Waveform** - (for PSA) Provides a view of the I/Q waveform graph in parameters of voltage versus time in linear scale. Changes to sweep time or resolution bandwidth can affect data acquisition.
- **Spectrum Linear** - (for E4406A) Provides a view of the linear spectrum graph in parameters of voltage and versus frequency with the linear graticules. Changes to frequency span or voltage will sometimes affect data acquisition.

**Figure 4-22** Spectrum Measurement - Linear Spectrum View (for E4406A)

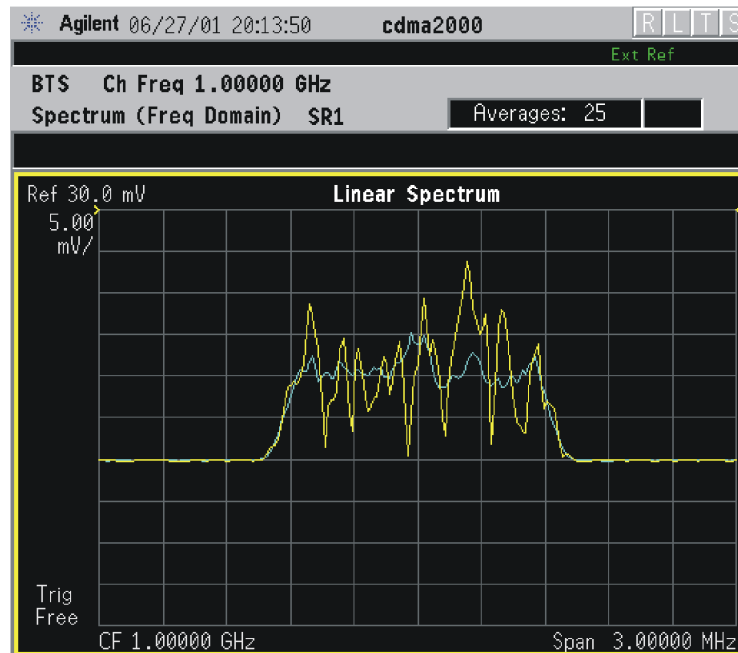

\*Meas Setup: View/Trace = Spectrum Linear,  
Span = 3.000 MHz,  
Y Scale/Div = 5.00 mV, Ref Value = 30.0 mV,  
Others = Factory default settings

\*Input signals: -10.00 dBm, 9 channels of SR1, cdma2000 Rev 8

**NOTE**

(for E4406A) For the widest spans, the I/Q window becomes just “ADC time domain samples”, because the I/Q down-conversion is no longer in effect. This is not the case for E4406A Option B7C if the **Input Port** is set to **I/Q** and you have connected baseband I/Q signals to the **I/Q INPUT** connectors.

- **I/Q Waveform** - Provides a window view of the I/Q waveform graph in parameters of voltage versus time in the linear graticules. Changes to sweep time or resolution bandwidth will sometimes affect data acquisition. This is equivalent to change the selected window with the **Next** key.
- **I and Q Waveform** - (for E4406A) Provides the individual views of the I and Q signal waveform windows in the parameters of voltage versus time.

**Figure 4-23** Spectrum Measurement - I and Q Waveform View (for E4406A)

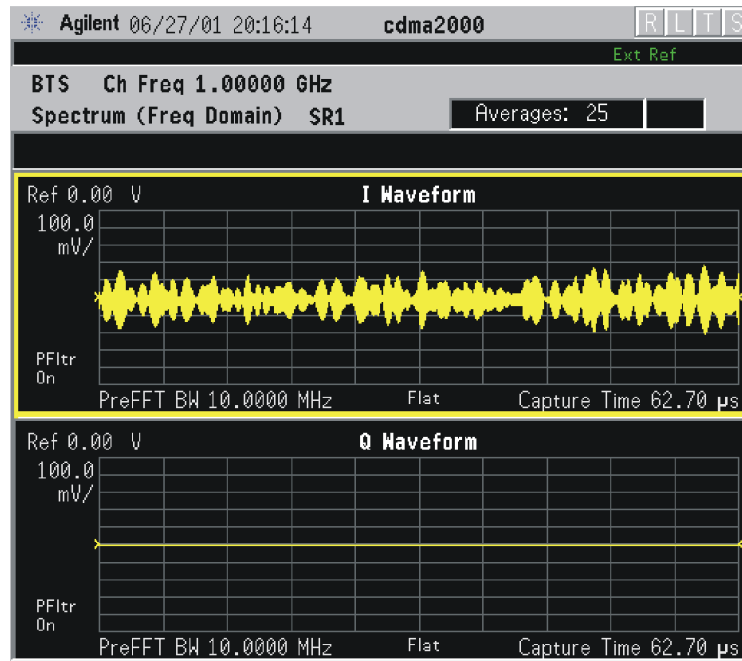

\*Meas Setup: View/Trace = I and Q Waveform,  
 AMPLITUDE Y Scale = 5.00 mV,  
 Others = Factory default settings

\*Input signals: -10.00 dBm, 9 channels of SR1, cdma2000 Rev 8

- **I/Q Polar** - (for E4406A) Provides a view of the I/Q signal polar vector graph.

**Figure 4-24 Spectrum Measurement - I/Q Polar View (for E4406A)**

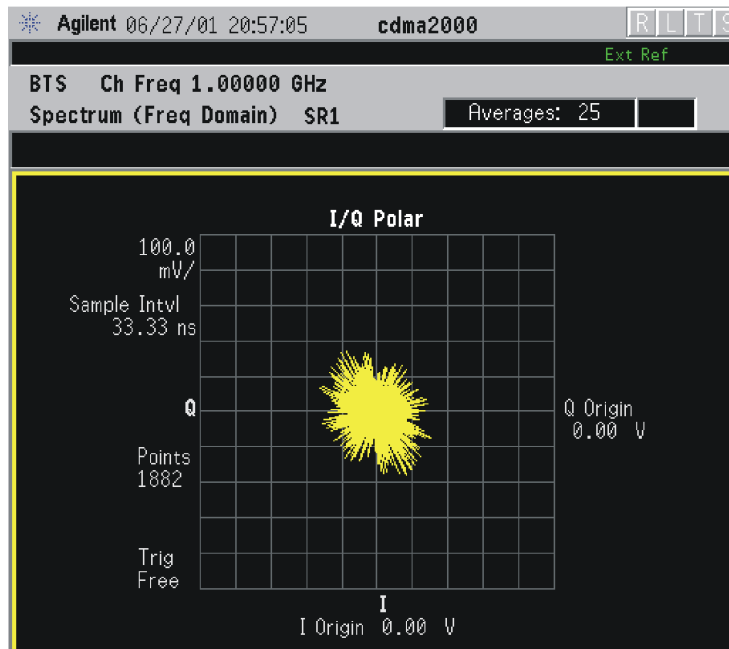

\*Meas Setup: View/Trace = I/Q Polar,  
 Others = Factory default settings

\*Input signals: -10.00 dBm, Pilot channel of SR1, cdma2000 Rev 8

### Changing the Display

The **Span** key under the **Meas Setup** menu controls the horizontal span of the spectrum window. If the **SPAN X Scale** key is pressed, this **Span** key is activated, while the **AMPLITUDE Y Scale** key allows you to access the menus to modify the vertical parameters depending on the selected windows.

### Changing the Spectrum Display

If the Spectrum or Linear Spectrum (for E4406A) window is active in the **Spectrum** or **Spectrum Linear** (for E4406A) view, the **SPAN X Scale** and **AMPLITUDE Y Scale** keys access the menus to modify the following parameters:

- With the **SPAN X Scale** key:
  - **Span** - Allows you to modify the frequency span. The range is 10.000 Hz to 10.000 MHz with 1 Hz resolution, depending on the **Res BW** setting. Changing the span causes the resolution bandwidth to change automatically, and will affect data acquisition time.
- With the **AMPLITUDE Y Scale** key:
  - **Scale/Div** - Allows you to set the vertical scale by changing an

amplitude value per division. The range is 0.10 dB to 20.00 dB per division or 1.00 nV to 20.00 V per division, respectively. The default setting is 10.00 dB or 100.0 mV. However, since the **Scale Coupling** default is **On**, this value is automatically determined by the measurement results. When you set a value manually, **Scale Coupling** automatically changes to **Off**.

- **Ref Value** - Allows you to set the reference value ranging from -250.00 to 250.00 dBm or -250.00 to 250.00 V. The default setting is 0.00 dBm or 0.00 V. However, since the **Scale Coupling** default is **On**, this value is automatically determined by the measurement results. When you set a value manually, **Scale Coupling** automatically changes to **Off**.
- **Ref Position** - Allows you to set the reference position to either **Top**, **Ctr** (center) or **Bot** (bottom). The default setting is **Ctr**.
- **Scale Coupling** - Allows you to toggle the scale coupling function between **On** and **Off**. The default setting is **On**. Upon pressing the **Restart** front-panel key or **Restart** softkey under the **Meas Control** menu, this function automatically determines the scale per division and reference values based on the measurement results. When you set a value to either **Scale/Div** or **Ref Value** manually, **Scale Coupling** automatically changes to **Off**.

### Changing the I or Q Waveform Window (for E4406A)

If the I or Q Waveform window is active in the I and Q Waveform view, the **SPAN X Scale** and **AMPLITUDE Y Scale** keys access the menu to modify the following parameters:

- With the **SPAN X Scale** key:
  - **Scale/Div** - Allows you to set the horizontal scale by changing a time value per division. The range is 1.00 ns to 1.00 s per division. The default setting is 18.8 ms per division. However, since the **Scale Coupling** default is **On**, this value is automatically determined by the measurement results. When you set a value manually, **Scale Coupling** automatically changes to **Off**.
  - **Ref Value** - Allows you to set the reference value ranging from -1.00 to 10.0 s. The default setting is 0.00 s. However, since the **Scale Coupling** default is **On**, this value is automatically determined by the measurement results. When you set a value manually, **Scale Coupling** automatically changes to **Off**.
  - **Ref Position** - Allows you to set the reference position to either **Left**, **Ctr** (center) or **Right**. The default setting is **Left**.
  - **Scale Coupling** - Allows you to toggle the scale coupling function between **On** and **Off**. The default setting is **On**. Upon pressing the **Restart** front-panel key or **Restart** softkey under the **Meas Control** menu, this function automatically determines the scale per

division and reference values based on the measurement results. When you set a value to either **Scale/Div** or **Ref Value** manually, **Scale Coupling** automatically changes to **Off**.

- With the **AMPLITUDE Y Scale** key:
  - **Scale/Div** - Allows you to set the vertical scale by changing the amplitude value per division. The range is 1.00 nV to 20.00 V per division. The default setting is 100.0 mV. However, since the **Scale Coupling** default is **On**, this value is automatically determined by the measurement results. When you set a value manually, **Scale Coupling** automatically changes to **Off**.
  - **Ref Value** - Allows you to set the reference value ranging from -250.00 to 250.00 V. The default setting is 0.00 V. However, since the **Scale Coupling** default is **On**, this value is automatically determined by the measurement results. When you set a value manually, **Scale Coupling** automatically changes to **Off**.
  - **Ref Position** - Allows you to set the reference position to either **Top**, **Ctr** (center) or **Bot** (bottom). The default setting is **Ctr**.
  - **Scale Coupling** - Allows you to toggle the scale coupling function between **On** and **Off**. The default setting is **On**. The **Restart** front-panel key or **Restart** softkey under the **Meas Control** menu, this function automatically determines the scale per division and reference values by the measurement results. When you set a value to either **Scale/Div** or **Ref Value** manually, **Scale Coupling** automatically changes to **Off**.

### Changing the I/Q Polar Window (for E4406A)

If the I/Q Polar window is active in the **I/Q Polar** view, the **SPAN X Scale** key or the **AMPLITUDE Y Scale** key access a menu to modify the following parameters:

- **I/Q Scale/Div** - Allows you to set the vertical and horizontal scales by changing the value per division. The range is 1.00 nV to 20.00 V per division. The default setting is 100.0 mV.
- **I Origin** or **Q Origin** - Allows you to set the reference value ranging from -250.00 to 250.00 V. The default setting is 0.00 V.

### Selecting Displayed Traces Within Windows

The **View/Trace** key allows you to access the **Trace Display** key to reveal the trace selection menu. The currently selected trace type is shown on the **Trace Display** key.

- **All** - Allows you to view both the current trace and the average trace.
- **Average** - Allows you to view only the average trace (in blue color).
- **Current** - Allows you to view only the trace (in yellow color) for the

latest data acquisition.

- **I Trace** - (for E4406A) Allows you to view only the I signal trace.
- **Q Trace** - (for E4406A) Allows you to view only the Q signal trace.

## Using the Markers

The **Marker** front-panel key accesses the menu to configure the markers. If you want to use the marker function in the I waveform window, press **View/Trace, I and Q Waveform, Marker, Trace, I Waveform**.

- **Select 1 2 3 4** - Allows you to activate up to four markers with the corresponding numbers, respectively. The selected number is underlined and its function is defined by pressing the **Function** key. The default is 1.
- **Normal** - Allows you to activate the selected marker to read the frequency and amplitude of the marker position on the spectrum trace. Marker position is controlled by the **RPG** knob.
- **Delta** - Allows you to read the differences in frequencies and amplitudes between the selected marker and the next.
- **Function Off** - Allows you to define the selected marker function to be **Band Power, Noise, or Off**. The default is **Off**. If set to **Band Power**, you need to select **Delta**.
- **Trace Spectrum** - Allows you to place the selected marker on the **Spectrum, Spectrum Avg, Spectrum Linear** (for E4406A), **Spectrum Avg Linear** (for E4406A), **I/Q Waveform, I Waveform** (for E4406A), or **Q Waveform** (for E4406A) trace. The default is **Spectrum**.
- **Off** - Allows you to turn off the selected marker.
- **Shape Diamond** - Allows you to access the menu to define the selected marker shape to be **Diamond, Line, Square, or Cross**. The default shape is **Diamond**.
- **Marker All Off** - Allows you to turn off all of the markers.

The front panel **Search** key performs a peak search when pressed. A marker will automatically be activated at the highest peak.

## Measuring Band Power

A band power measurement using the markers calculates the average power between two adjustable markers. To make a band power measurement:

1. Press the **Marker** key.
2. Press **Trace, Spectrum** to activate a marker on the instantaneous spectrum signal.
3. Press the **Spectrum Avg** key to activate a marker on the average

spectrum trace.

4. Press **Function**, **Band Power**.

5. Two marker lines are activated at the extreme left side of the horizontal scale. Press **Normal** and move marker 1 to the desired place by rotating the **RPG** knob.

6. Press **Delta** to bring marker 2 to the same place as marker 1.

7. Move marker 1 to the other desired position by rotating the **RPG** knob. Band power measures the average power between the two markers.

8. When the band power markers are active, the results are shown in the results window as Mean Pwr (Between Mks). When the band power function is off the results window reads Mean Pwr (Entire Trace).

## Troubleshooting Hints

Changes made by the user to advanced spectrum settings, particularly to ADC range settings, can inadvertently result in spectrum measurements that are invalid and cause error messages to appear. Care needs to be taken when using advanced features.



---

## Making the Waveform (Time Domain) Measurement

### Purpose

The waveform measurement is a generic measurement for viewing the input signal waveforms in the time domain. This measurement is how the instrument performs the zero span functionality found in traditional spectrum analyzers.

Basic mode waveform measurement data may be displayed using either a Signal Envelope window, or an I/Q window which shows the I and Q signal waveforms in parameters of voltage versus time. The advantage of having an I/Q view available while making a waveform measurement is that it allows you to view complex components of the same signal without changing settings or measurements.

For E4406A, an I/Q Polar display is also available to view the I and Q waveforms in a polar plot. This display shows the instantaneous relationship between the I and Q waveform voltages.

The waveform measurement can be used to perform general purpose power measurements in the time domain with excellent accuracy.

### Measurement Method

The instrument makes repeated power measurements at a set frequency, similar to the way a swept-tuned spectrum analyzer makes zero span measurements. The input analog signal is converted to a digital signal, which then is processed into a representation of a waveform measurement. The measurement relies on a high rate of sampling to create an accurate representation of a time domain signal.

For E4406A with Option B7C, this measurement is available for use with both the RF input and baseband I/Q inputs. For details on Baseband I/Q operation see the section on “Using Option B7C Baseband I/Q Inputs”.

### Making the Measurement

---

#### NOTE

The factory default parameters provide a good starting point. You may want to change some of the settings. Press **Meas Setup, More, Restore Meas Defaults** at any time to return all parameters for the current measurement to their default settings.

Press **MEASURE, Waveform (Time Domain)** to immediately make a waveform (time domain) measurement.

To change any of the measurement parameters from the factory default values, refer to the “Changing the Measurement Setup” section for this measurement.

## Results

The next figure shows an example of an RF Envelope (for E4406A) or Signal Envelope (for PSA) result for the waveform (time domain) measurements in the graph window. The measured values for the mean power and peak-to-mean power are shown in the text window.

Figure 4-25

Waveform Measurement - RF Envelope View

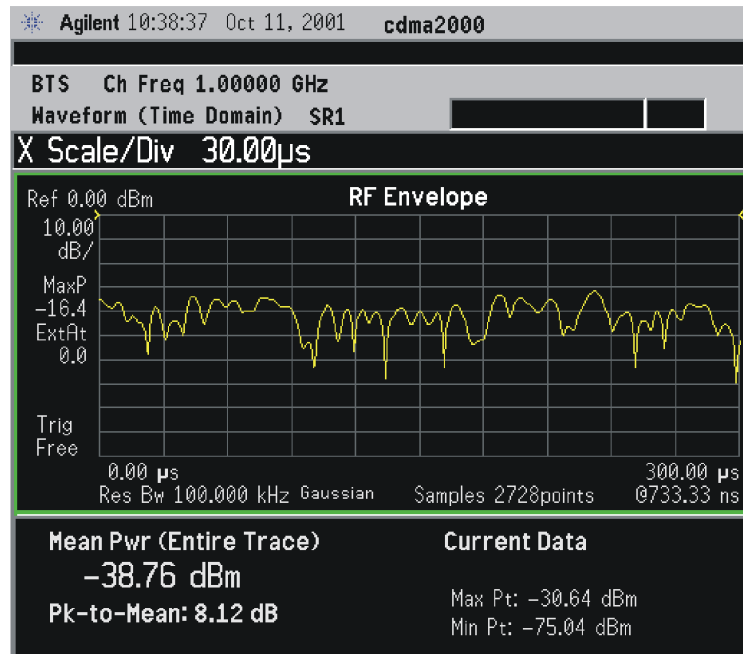

\*Meas Setup: Trace/View = RF Envelope,  
 Others = Factory default settings

\*Input signal: cdma2000 Rev 8, SR1, 9 Channel

## Changing the Measurement Setup

This table shows the factory default settings for waveform (time domain) measurements.

Table 4-18

Waveform (Time Domain) Measurement Defaults

Measurement Parameter	Factory Default Condition
View/Trace	RF Envelope (for E4406A)
Sweep Time	2.000 ms
Res BW	100.000 kHz

**Table 4-18 Waveform (Time Domain) Measurement Defaults**

<b>Measurement Parameter</b>	<b>Factory Default Condition</b>
Averaging: Avg Number Avg Mode Avg Type	10; Off Exp Pwr Avg (RMS)
Trig Source	Free Run (Immediate)
<b>RF Envelope View</b> SPAN X Scale - Scale/Div AMPLITUDE Y Scale - Scale/Div	<b>(for E4406A)</b> 200.0 $\mu$ s 10.00 dB
<b>Signal Envelope View</b> SPAN X Scale - Scale/Div AMPLITUDE Y Scale - Scale/Div	<b>(for PSA)</b> 200.0 $\mu$ s 10.00 dB
<b>Linear Envelope View</b> SPAN X Scale - Scale/Div <b>Linear Envelope window:</b> AMPLITUDE Y Scale - Scale/Div <b>Phase window:</b> AMPLITUDE Y Scale - Scale/Div	<b>(for E4406A Option B7C)</b> 200.0 $\mu$ s 100.0 mV 30.0 deg
<b>I/Q Waveform View:</b> SPAN X Scale -Scale/Div AMPLITUDE Y Scale - Scale/Div	200.0 $\mu$ s 100.0 mV
<b>I and Q Waveform View:</b> SPAN X Scale -Scale/Div AMPLITUDE Y Scale - Scale/Div	<b>(for E4406A Option B7C)</b> 200.0 $\mu$ s 100.0 mV
<b>I/Q Polar View:</b> I/Q Scale/Div I or Q Origin	<b>(for E4406A)</b> 100.0 mV 0.00 V
<b>Advanced</b>	
Pre-ADC BPF	Off
RBW Filter	Gaussian
ADC Range	Auto
Data Packing	Auto
ADC Dither	Off
Decimation	Off

**NOTE** Parameters that are under the **Advanced** key seldom need to be changed. Any changes from the default values may result in invalid measurement data.

Make sure the **Waveform (Time Domain)** measurement is selected under

the **MEASURE** menu. Press the **Meas Setup** key to access a menu which allows you to modify the averaging, and trigger source for this measurement (as described in the “Measurement Setup” section).

In addition, the following parameters can be modified:

- **Sweep Time** - Allows you to specify the measurement acquisition time which is used as the length of the time capture record. The range is 1.0  $\mu$ s and 100.0 s, depending upon the resolution bandwidth setting and the available internal memory size for acquisition points.
- **Res BW** - Allows you to set the measurement bandwidth. The range is 10 Hz to 8 MHz using the **Gaussian** filter selected from **RBW Filter** under the **Advanced** menu, or 10 Hz to 10 MHz using the **Flat** top filter selected from **RBW Filter**. A larger bandwidth results in a larger number of acquisition points and reduces the maximum value allowed for the sweep time.
- **Advanced** - Allows you to access the menu to change the following parameters. Changes from the default values may result in invalid data.
  - **Pre-ADC BPF** - Allows you to toggle the pre-ADC bandpass filter function between **On** or **Off**. The default setting is **Off**. The pre-ADC bandpass filter is useful for rejecting nearby signals, so that sensitivity within the span range can be improved by increasing the ADC range gain.
  - **RBW Filter** - Allows you toggle the resolution bandwidth filter selection between **Flat** and **Gaussian**. If set to **Gaussian**, the filter provides more even time-domain response, particularly for “bursts”. If set to **Flat**, the filter provides a flatter bandwidth but is less accurate for “pulse responses”. A flat top filter also requires less memory and allows longer data acquisition times. For most waveform applications, the Gaussian filter is recommended. The resolution bandwidth range is 10 Hz to 8 MHz using the Gaussian filter or 10 Hz to 10 MHz using the Flat top filter.
  - **ADC Range** - Allows you to access the menu to select one of the ADC ranging functions:
    - Auto** - Select this to cause the instrument to automatically adjust the signal range for optimal measurement results.
    - AutoPeak** - Select this to cause the instrument to continuously seek the highest peak signal.
    - AutoPeakLock** - Select this to cause the instrument to adjust the range for the highest peak signal it identifies, and retains the range settings determined by that peak signal, even when the peak signal is no longer present.
    - Manual** - Allows you to access the selection menu of values, -6 to +24 dB for E4404A or None to +18 dB for PSA, to set the

ADC range level. Also note that manual ranging is best for CW signals.

- **Data Packing** - Allows you to select **Auto** (the default) or the **Short (16 bit)**, **Medium (24 bit)** and **Long (32 bit)** methods of data packing. The short, medium, and long methods are not compatible with all settings and should not be used unless you are familiar with data packing methods. **Auto** is the preferred choice.
  - Auto** - The data packing value most appropriate for current instrument settings is selected automatically.
  - Short (16 bit)** - Select this to pack data every 16 bits.
  - Medium (24 bit)** - Select this to pack data every 24 bits.
  - Long (32 bit)** - Select this to pack data every 32 bits.
- **ADC Dither** - Allows you to toggle the ADC dither function between **On** and **Off**. The default setting is **Off**. If set to **On**, the ADC dither refers to the introduction of noise to the digitized steps of the analog-to-digital converter, and results in better amplitude linearity and resolution in low level signals. However, it also results in reduced dynamic range by approximately 3 dB.
- **Decimation** - Allows you to toggle the decimation function between **On** and **Off**, and to set the decimation value. Decimation allows longer acquisition times for a given bandwidth by eliminating data points. Long time captures can be limited by the instrument data acquisition memory. Decimation numbers 1 to 4 describe the factor by which the number of points are reduced. The default setting is 1, which results in no data point reduction.

## Changing the View

The **View/Trace** key allows you to access the selection menu for the desired measurement view. You can use the **Next Window** key to move between the multiple windows (if any) and make it full size by **Zoom**.

## Windows Available for Waveform Measurements

The following views are available to display measurement data, and are accessed by pressing the **Trace/View** (for PSA) or **View/Trace** (for E4406A) key:

- **RF Envelope** (for E4406A) or **Signal Envelope** (for PSA) - Provides a combination view of the waveform graph in parameters of power versus time with semi-log graticules. The measurement results for Mean Pwr (Entire Trace), Pk-to-Mean, Current Data for Max Pt and Min Pt are shown in the text window as shown in [“Results” on page 226](#). Changes to sweep time or resolution bandwidth can affect data acquisition.
- **Linear Envelope** - (for E4406A Option B7C) Provides a combination

view of the linear signal envelope graph and the linear phase graph with the linear graticules.

Figure 4-26 Waveform Measurement - Linear Envelope View

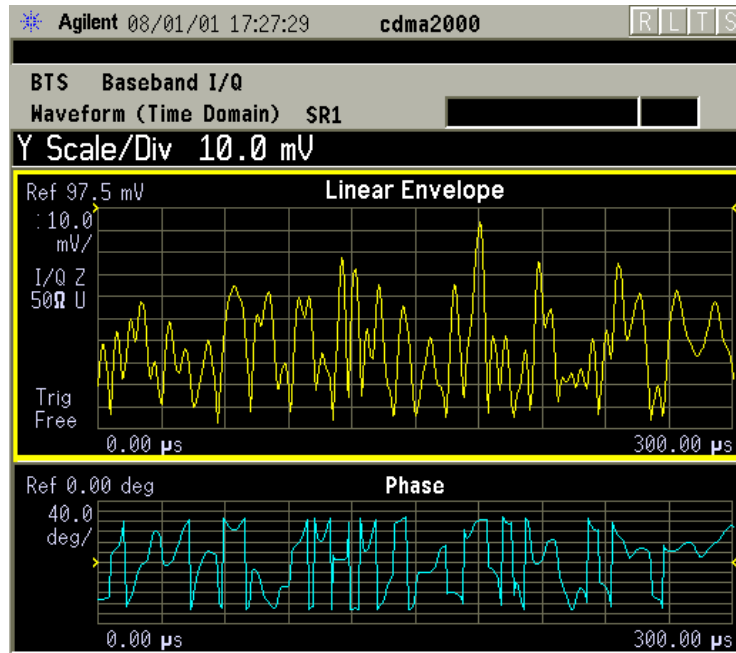

\*Meas Setup: View/Trace = Linear Envelope View,  
Others = Factory defaults, except X and Y scales

\*Input signal: cdma2000 Rev 8, SR1, 9 Channel

- **I/Q Waveform** - Provides a view of the I/Q waveform graph in parameters of voltage versus time in linear scale. Changes to sweep time or resolution bandwidth can affect data acquisition.

**NOTE**

For the widest spans the I/Q Waveform window becomes just “ADC time domain samples”, because the I/Q down-conversion is no longer in effect.

**Figure 4-27** Waveform Measurement - I/Q Waveform View

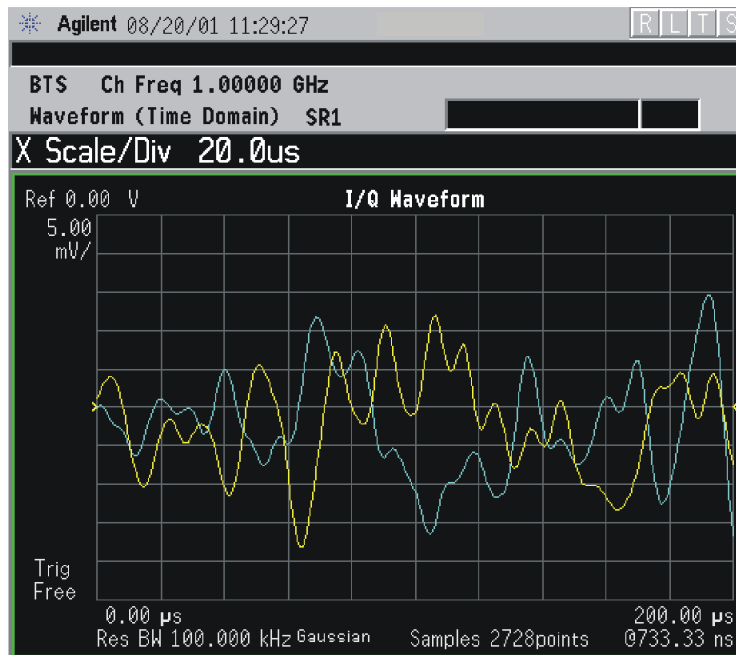

\*Meas Setup: View/Trace = I/Q Waveform,  
Others = Factory defaults, except X and Y scales

\*Input signal: cdma2000 Rev 8, SR1, 9 Channel

**NOTE**

For the widest spans the I/Q Waveform window becomes just “ADC time domain samples”, because the I/Q down-conversion is no longer in effect.

- **I and Q Waveform** - (for E4406A Option B7C) Provides a combination view of the I and Q signal waveform graphs in the linear scales.

Figure 4-28 Waveform Measurement - I and Q Waveform View

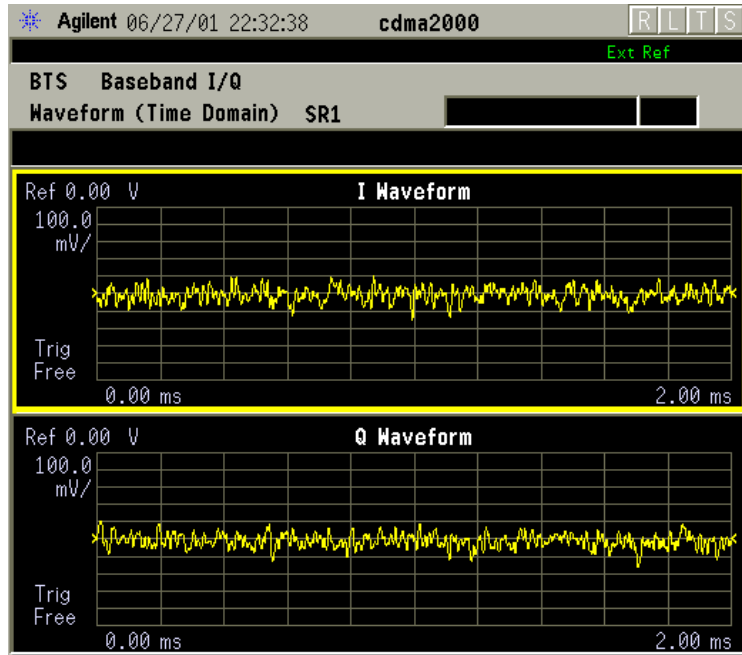

\*Meas Setup: View/Trace = I and Q Waveform View,  
Others = Factory defaults, except X and Y scales

\*Input signal: cdma2000 Rev 8, SR1, 9 Channel

- I/Q Polar - (for E4406A) Provides a view of the I/Q signal in a polar vector graph.

Figure 4-29 Waveform Measurement - I/Q Polar View

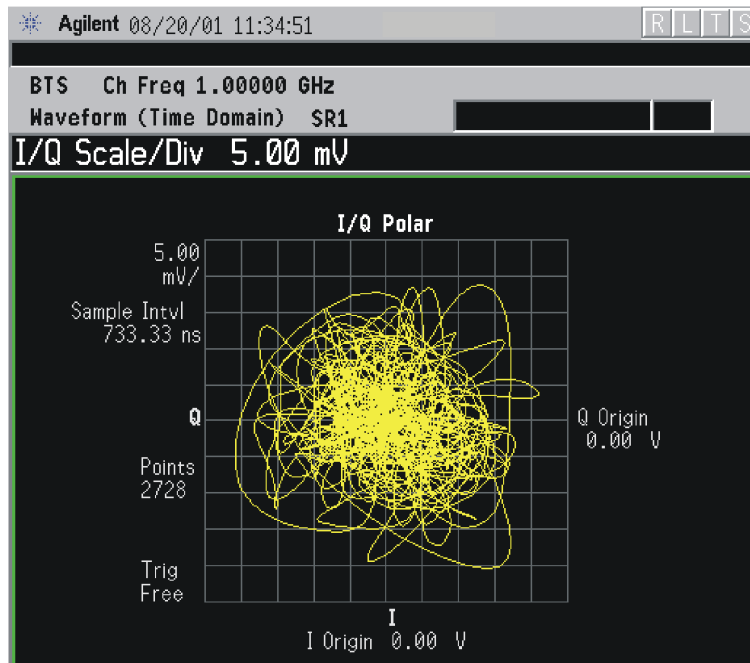



- \*Meas Setup: View/Trace = I/Q Polar View,  
Others = Factory defaults, except X and Y scales
- \*Input signal: cdma2000 Rev 8, SR1, 9 Channel

## Changing the Display

The **Sweep Time** key under the **Meas Setup** menu controls the horizontal time span for this measurement, while the **SPAN X Scale** key allows you to access the menu to modify the horizontal parameters common to the rectangular windows for this measurement:

- **Scale/Div** - Allows you to set the horizontal scale by changing a time value per division. The range is 1.0 ns to 1.000 s per division with 0.01 ns resolution. The default setting is 200.0  $\mu$ s per division. However, since the **Scale Coupling** default is **On**, this value is automatically determined by the measurement result. When you set a value manually, **Scale Coupling** automatically changes to **Off**.
- **Ref Value** - Allows you to set the reference value ranging from -1.0 to 10.0 s. The default setting is 0.00 s. However, since the **Scale Coupling** default is **On**, this value is automatically determined by the measurement result. When you set a value manually, **Scale Coupling** automatically changes to **Off**.
- **Ref Position** - Allows you to set the reference position to either **Left**, **Ctr** (center) or **Right**. The default setting is **Left**.
- **Scale Coupling** - Allows you to toggle the scale coupling function between **On** and **Off**. The default setting is **On**. Upon pressing the **Restart** front-panel key or **Restart** softkey under the **Meas Control** menu, this function automatically determines the scale per division and reference values based on the measurement results. When you set a value to either **Scale/Div** or **Ref Value** manually, **Scale Coupling** automatically changes to **Off**.

If the RF Envelope (for E4406A) or Signal Envelope (for PSA) window is active in the **RF Envelope** (for E4406A) or **Signal Envelope** (for PSA) view, the **AMPLITUDE Y Scale** key accesses the menu to modify the following parameters:

- **Scale/Div** - Allows you to set the vertical scale by changing an amplitude value per division. The range is 0.10 to 20.00 dB per division with 0.01 dB resolution. The default setting is 10.00 dB per division. However, since the **Scale Coupling** default is **On**, this value is automatically determined by the measurement result. When you set a value manually, **Scale Coupling** automatically changes to **Off**.
- **Ref Value** - Allows you to set the reference value ranging from -250.00 to 250.00 dBm. The default setting is 0.00 dBm. However, since the **Scale Coupling** default is **On**, this value is automatically determined by the measurement result. When you set a value

manually, **Scale Coupling** automatically changes to **Off**.

- **Ref Position** - Allows you to set the reference position to either **Top**, **Ctr** (center) or **Bot** (bottom). The default setting is **Top**.
- **Scale Coupling** - Allows you to toggle the scale coupling function between **On** and **Off**. The default setting is **On**. Upon pressing the **Restart** front-panel key or **Restart** softkey under the **Meas Control** menu, this function automatically determines the scale per division and reference values based on the measurement results. When you set a value to either **Scale/Div** or **Ref Value** manually, **Scale Coupling** automatically changes to **Off**.

For E4406A with Option B7C, if the **Linear Envelope** window is active in the **Linear Envelope** view, the **AMPLITUDE Y Scale** key accesses the menu to modify the following parameters:

- **Scale/Div** - Allows you to set the vertical scale by changing an amplitude value per division. The range is 1.00 nV to 20.00 V per division. The default setting is 100.0 mV per division. However, since the **Scale Coupling** default is **On**, this value is automatically determined by the measurement result. When you set a value manually, **Scale Coupling** automatically changes to **Off**.
- **Ref Value** - Allows you to set the reference value ranging from -250.00 to 250.00 V. The default setting is 0.00 V. However, since the **Scale Coupling** default is **On**, this value is automatically determined by the measurement result. When you set a value manually, **Scale Coupling** automatically changes to **Off**.
- **Ref Position** - Allows you to set the reference position to either **Top**, **Ctr** (center) or **Bot** (bottom). The default setting is **Top**.
- **Scale Coupling** - Allows you to toggle the scale coupling function between **On** and **Off**. The default setting is **On**. Upon pressing the **Restart** front-panel key or **Restart** softkey under the **Meas Control** menu, this function automatically determines the scale per division and reference values based on the measurement results. When you set a value to either **Scale/Div** or **Ref Value** manually, **Scale Coupling** automatically changes to **Off**.

For E4406A with Option B7C, if the **Phase** window is active in the **Linear Envelope** view, the **AMPLITUDE Y Scale** key accesses the menu to modify the following parameters:

- **Scale/Div** - Allows you to set the vertical scale by changing an amplitude value per division. The range is 0.10 to 3600.0 deg per division. The default setting is 30.00 deg. However, since the **Scale Coupling** default is **On**, this value is automatically determined by the measurement result. When you set a value manually, **Scale Coupling** automatically changes to **Off**.
- **Ref Value** - Allows you to set the reference value ranging from

–36000.0 to 36000.0 deg. The default setting is 0.00 deg. However, since the **Scale Coupling** default is **On**, this value is automatically determined by the measurement result. When you set a value manually, **Scale Coupling** automatically changes to **Off**.

- **Ref Position** - Allows you to set the reference position to either **Top**, **Ctr** (center) or **Bot** (bottom). The default setting is **Ctr**.
- **Scale Coupling** - Allows you to toggle the scale coupling function between **On** and **Off**. The default setting is **On**. Upon pressing the **Restart** front-panel key or **Restart** softkey under the **Meas Control** menu, this function automatically determines the scale per division and reference values based on the measurement results. When you set a value to either **Scale/Div** or **Ref Value** manually, **Scale Coupling** automatically changes to **Off**.

If the I/Q Waveform window is active in the **I/Q Waveform** view (or the I Waveform, or Q Waveform window is active in the **I and Q Waveform** view for E4406A with Option B7C), the **AMPLITUDE Y Scale** key accesses the menu to modify the following parameters:

- **Scale/Div** - Allows you to set the vertical scale by changing an amplitude value per division. The range is 1.00 nV to 20.00 V per division. The default setting is 100.0 mV. However, since the **Scale Coupling** default is **On**, this value is automatically determined by the measurement result. When you set a value manually, **Scale Coupling** automatically changes to **Off**.
- **Ref Value** - Allows you to set the reference value ranging from –250.00 to 250.00 V. The default setting is 0.00 V. However, since the **Scale Coupling** default is **On**, this value is automatically determined by the measurement result. When you set a value manually, **Scale Coupling** automatically changes to **Off**.
- **Ref Position** - Allows you to set the reference position to either **Top**, **Ctr** (center) or **Bot** (bottom). The default setting is **Ctr**.
- **Scale Coupling** - Allows you to toggle the scale coupling function between **On** and **Off**. The default setting is **On**. Upon pressing the **Restart** front-panel key or **Restart** softkey under the **Meas Control** menu, this function automatically determines the scale per division and reference values based on the measurement results. When you set a value to either **Scale/Div** or **Ref Value** manually, **Scale Coupling** automatically changes to **Off**.

For E4406A, if the I/Q Polar window is active in the **I/Q Polar** view, the **SPAN X Scale** or **AMPLITUDE Y Scale** key accesses the menu to modify the following parameters:

- **I/Q Scale/Div** - Allows you to set the vertical and horizontal scales by changing a value per division. The range is 1.00 nV to 20.00 V per division. The default setting is 100.0 mV.

- **I or Q Origin** - Allows you to set the reference value ranging from -250.00 to 250.00 V. The default setting is 0.00 V.

The **Display** key is not available for this measurement.

## Using the Markers

The **Marker** front-panel key accesses the menu to configure the markers.

- **Select 1 2 3 4** - Allows you to activate up to four markers with the corresponding numbers, respectively. The selected number is underlined and its function is defined by pressing the **Function** key. The default is 1.
- **Normal** - Allows you to activate the selected marker to read the time position and amplitude of the marker on the RF envelope or Signal Envelope trace. Marker position is controlled by the **RPG** knob.
- **Delta** - Allows you to read the differences in time positions and amplitudes between the selected marker and the next.
- **Function Off** - Allows you to define the selected marker function to be **Band Power**, **Noise**, or **Off**. The default is **Off**. If set to **Band Power**, you need to select **Delta**.
- **Trace** - Allows you to place the selected marker on **RF Envelope** (for E4406A), **Signal Envelope** (for PSA), or **I/Q Waveform**. Also, for E4406A with Option B7C, you can place the marker on **Linear Envelope**, **Linear Phase**, **I Waveform**, or **Q Waveform**.
- **Off** - Allows you to turn off the selected marker.
- **Shape Diamond** - Allows you to access the menu to define the selected marker shape to be **Diamond**, **Line**, **Square**, or **Cross**. The default shape is **Diamond**.
- **Marker All Off** - Allows you to turn off all of the markers.

The front panel **Search** key performs a peak search when pressed. A marker will automatically be activated at the highest peak.

---

### NOTE

In the Waveform measurement, the Mean Pwr (Entire Trace) value plus the Pk-to-Mean value will sum to equal the current Max Pt. value as shown in the data window below the RF Envelope or Signal Envelope display. If you do a marker peak search (**Search**) with averaging turned off, the marker will find the same maximum point. However, if you turn averaging on, the Pk-to-Mean value will use the highest peak found for any acquisition during averaging, while the marker peak will look for the peak of the display, which is the result of n-averages. This will usually result in differing values for the maximum point.

---

## Troubleshooting Hints

Changes made to advanced waveform settings can inadvertently result in measurements that are invalid and cause error messages to appear. Care needs to be taken when using advanced features, as some settings may incorrectly appear to provide a valid result. Use the **Meas Setup, More, Restore Meas Defaults** function to return the measurement settings to a known state, and then vary settings only as necessary.

---

## Using Option B7C Baseband I/Q Inputs

The E4406A VSA Option B7C Baseband I/Q Inputs provides the ability to analyze baseband I/Q signal characteristics of mobile and base station transmitters. This option may be used only in conjunction with the following personalities:

- Basic mode (available in all VSA Series Transmitter Testers)
- Option BAF W-CDMA Measurement Personality
- Option B78 cdma2000 Measurement Personality
- Option 202 GSM with EDGE

### What are Baseband I/Q Inputs?

Option B7C consists of a Baseband Input module, four 50  $\Omega$  BNC connectors, and internal cabling. The four BNC connectors are grouped into pairs at the upper left corner of the front panel. The upper two connectors labeled “I” and “Q” are the “unbalanced” inputs.

In practice, an unbalanced or “single-ended” baseband measurement of an I or Q signal is made using a probe connected to the I or Q connector. A simultaneous I/Q unbalanced single-ended measurement may be made using two probes connected to the I and Q input connectors.

If “balanced” signals are available, they may be used to make a more accurate measurement. Balanced signals are signals present in two separate conductors, are symmetrical about ground, and are opposite in polarity, or out of phase by 180 degrees.

Measurements using balanced signals can have a higher signal to noise ratio resulting in improving accuracy. Noise coupled into each conductor equally in a “common mode” to both signals may be separated from the signal. The measure of this separation is “common-mode rejection”.

To make a balanced measurement, the lower two connectors labeled “ $\bar{I}$ ” and “ $\bar{Q}$ ” are used in conjunction with the I and Q inputs. The terms “I-bar” and “Q-bar” may be applied to the signals, as well as the inputs themselves. Probes (customer provided) must be used to input balanced baseband I/Q signals. This may be referred to as a balanced measurement.

Balanced baseband measurements are made using the I and  $\bar{I}$  connectors for I only signal measurements, while the Q and  $\bar{Q}$  connectors are used for a Q only signal measurement. Balanced measurements of I/Q require differential probe connections to all four input connectors. For details of probe selection and use, refer to [“Selecting Input Probes for Baseband Measurements” on page 240.](#)

## What are Baseband I/Q Signals?

In transmitters, the term baseband I/Q refers to signals that are the fundamental products of individual I/Q modulators, before the I and Q component signals are combined, and before upconversion to IF or RF frequencies.

In receivers, baseband I/Q analysis may be used to test the I and Q products of I/Q demodulators, after an RF signal has been downconverted and demodulated.

## Why Make Measurements at Baseband?

Baseband I/Q measurements are a valuable means of making qualitative analyses of the following operating characteristics:

- I/Q signal layer access for performing format-specific demodulation measurements (e.g. CDMA, GSM, W-CDMA):
  - rho
  - error vector magnitude; rms, peak, or 95%
  - carrier feed-through
  - frequency error
  - magnitude and phase errors
- Code-domain analysis (including code-specific metrics)
- CCDF of  $I^2 + Q^2$
- Single sideband (SSB) metrics for assessing output quality
- Basic analysis of I and Q signals in isolation including: DC content, rms and peak to peak levels, CCDF of each channel

Comparisons of measurements made at baseband and RF frequencies produced by the same device are especially revealing. Once signal integrity is verified at baseband, impairments can be traced to specific stages of upconversion, amplification, or filtering by RF analysis. Likewise, impairments to signal quality that are apparent at RF frequencies may be traceable to baseband using baseband analysis.

## Making Measurements with Baseband I/Q Inputs

Baseband I/Q measurements are similar to RF measurements. To avoid duplication, this section describes only the details unique to using the baseband I/Q inputs. For generic measurement details, refer to the previous “Making Measurements” sections.

The following measurements are available for use with the baseband

I/Q inputs:

- Channel Power
- Occupied Bandwidth
- Code Domain
- Modulation Accuracy (Composite Rho)
- QPSK EVM
- Power Stat CCDF
- Spectrum (Frequency Domain)
- Waveform (Time Domain)

---

**NOTE**

The following measurements are not available for use with Option B7C Baseband I/Q Inputs:

- ACPR
  - Intermodulation
  - Spectrum Emission Mask
  - Multi Carrier Power
- 

## Baseband I/Q Measurement Overview

To make measurements using baseband I/Q Inputs, you must make the following selections:

- Select a measurement that supports baseband I/Q inputs. For details see [“Making Measurements with Baseband I/Q Inputs” on page 239](#).
- Select the appropriate circuit location and probe(s) for measurements. For details see [“Selecting Input Probes for Baseband Measurements” on page 240](#).
- Select baseband I/Q input connectors. For details see [“Selecting Baseband I/Q Input Connectors” on page 244](#).
- Adjust I/Q Setup if desired. For details see [“Setting Up Baseband I/Q Inputs” on page 245](#).
- Select baseband I/Q input impedance. For details see [“Selecting Baseband I/Q Input Impedance” on page 247](#).
- Select a baseband I/Q measurement results view. For details see [“Baseband I/Q Measurement Views” on page 248](#).

## Selecting Input Probes for Baseband Measurements

The selection of baseband measurement probe(s) and measurement



method is primarily dependent on the location of the measurement point in the circuit. The probe must sample voltages without imposing an inappropriate load on the circuit.

The following measurement methods may be used with baseband I/Q inputs:

- **50  $\Omega$  Unbalanced** - This is the measurement method of choice if single-ended or unbalanced baseband I and/or Q signals are available in 50  $\Omega$  coaxial transmission lines and are terminated in a coaxial connectors. Adapters necessary to convert to a 50  $\Omega$  BNC-type male connector must be of 50  $\Omega$  impedance.

The methods are as follows:

- I only measurement using one single-ended probe connected to the I input connector (available in the Basic mode)
  - Q only measurement using one single-ended probe connected to the Q input connector (available in the Basic mode)
  - I/Q measurement using two single-ended probes connected to the I and Q input connectors
- **600  $\Omega$  Balanced** - This is the measurement method of choice if balanced baseband signals having a 600  $\Omega$  impedance are available. The methods are as follows:
    - I only measurement using one differential probe or two single-ended probes connected to the I and  $\bar{I}$  inputs (available in the Basic mode)
    - Q only measurement using one differential probe or two single-ended probes connected to the Q and  $\bar{Q}$  inputs (available in the Basic mode)
    - I/Q measurement using two differential probes or four single-ended probes connected to the I, Q,  $\bar{I}$ , and  $\bar{Q}$  input connectors
  - **1 M $\Omega$  Unbalanced** - High input impedance is the measurement method of choice if single-ended or unbalanced baseband signals to be measured lie in a trace on a circuit board and are sensitive to loading by the probe. This is the default input connector setting.

When making 1 M $\Omega$  measurements, the reference input impedance may be adjusted. For details refer to [“Setting Up Baseband I/Q Inputs” on page 245](#). 1 M $\Omega$  unbalanced measurements may be made as follows:

- I only measurement using one single-ended probe connected to the I input connector (available in the Basic mode)
- Q only measurement using one single-ended probe connected to the Q input connector (available in the Basic mode)

- I/Q measurement using two single-ended probes connected to the I and Q input connectors
- **1 M $\Omega$  Balanced** - High input impedance measurements may also be made if differential or balanced signals are available. 1 M $\Omega$  balanced measurements may be made as follows:
  - I only measurement using one differential probe or two single-ended probes connected to the I and  $\bar{I}$  inputs (available in the Basic mode)
  - Q only measurement using one differential probe or two single-ended probes connected to the Q and  $\bar{Q}$  inputs (available in the Basic mode)
  - I/Q measurement using two differential probes or four single-ended probes connected to the I, Q,  $\bar{I}$ , and  $\bar{Q}$  input connectors

This is the measurement method of choice if differential or balanced baseband signals to be measured lie in a trace on a circuit board and are sensitive to loading by the probe. When making 1 M $\Omega$  measurements, the reference input impedance may be adjusted. For details refer to “[Setting Up Baseband I/Q Inputs](#)” on page 245.

The following table lists the probes currently available from Agilent, which are suitable for use under various measurement conditions:

Table 4-19

**Agilent Probes - Balanced and Unbalanced**

Probe Type	Description
Unbalanced (single-ended)	1144A 800 MHz Active Probe <sup>abc</sup> 54701A 2.5 GHz Active Probe <sup>bcd</sup> 1145A 750 MHz 2-Channel Active Probe <sup>abc</sup> 85024A High Frequency Probe <sup>be</sup> 41800A Active Probe <sup>bf</sup> 10020A Resistive Divider Probe <sup>bc</sup> 54006A 6 GHz Passive Divider Probe <sup>g</sup>
Balanced (differential)	1141A 200 MHz Active Differential Probe <sup>abc</sup> N1025A 1 GHz Active Differential Probe <sup>bh</sup>

- a. Not compatible with 3-wire power interface. Needs 1142A power supply. For two channels, you will need either two 1142A power supplies or one 1142A power supply and one 01144-61604 1-input, two-output adapter cable.
- b. Two probes needed to cover both I and Q inputs.
- c. Output connector is BNC-type.
- d. Not compatible with 3-wire power interface. Requires use of 1143A power supply that can power two 54701A probes.
- e. 85024A bandwidth is 300 kHz to 3 GHz. Output connector is N-type. Power is 3-wire connector (+15 V, -12.6 V, ground).
- f. 41800A bandwidth is 5 Hz to 500 MHz. Output connector is N-type. Power is 3-wire connector (+15 V, -12.6 V, ground).
- g. 54006A output connector is 3.5 mm
- h. 3.5 mm output connector, requires ±15 V supply.

Refer to the current Agilent data sheet for each probe for specific information regarding frequency of operation and power supply requirements.

The E4406A Transmitter Tester provides one “three-wire” probe power connector on the front panel. Typically, it can energize one probe. If you plan on operating more than one probe, make sure you provide sufficient external power sources as required.

### Selecting Baseband I/Q Inputs

Baseband I/Q measurements may be made with “unbalanced” inputs using either two connectors (I and Q), or with “balanced” inputs using four connectors (I, Q,  $\bar{I}$ , and  $\bar{Q}$ ). A variety of high and low input impedances can be selected. This flexibility allows measurements to be made at a maximum number of diagnostic locations in the transmitter circuitry.

To use the baseband I/Q inputs the instrument must be in cdma2000 Mode, or another compatible mode which can utilize the baseband I/Q input ports. For modes that support baseband I/Q, the inputs and measurement defaults are activated and visible when either **I only**, **Q only**, or **I/Q** is selected for **Input Port** under **Input/Output**. For modes which cannot support baseband I/Q measurements, these softkeys are not available.

### Selecting Baseband I/Q Input Connectors

Option B7C adds a softkey menu that lets you select I/Q inputs. This menu is located under the **Input/Output** front-panel key. To select an input connector press **Input/Output**, or **Input Port** under **Mode Setup**. Select the desired input connector(s) from the following choices displayed:

- **RF** - Press to select the 50  $\Omega$  N-type RF connector.
- **I/Q** - Select if using 2-connector “unbalanced” or 4-connector “balanced” I/Q connections. Complete your selection by choosing the appropriate input impedance and connectors in the section [“Selecting Baseband I/Q Input Impedance” on page 247](#).
- **I only** - Select if using I and/or  $\bar{I}$  input connectors (available in the Basic mode). Complete your selection by choosing the appropriate input impedance and connectors in the section [“Selecting Baseband I/Q Input Impedance” on page 247](#).
- **Q only** - Select if using Q and/or  $\bar{Q}$  input connectors (available in the Basic mode). Complete your selection by choosing the appropriate input impedance and connectors in the section [“Selecting Baseband I/Q Input Impedance” on page 247](#).
- **50 MHz Ref** - Select to view the 50 MHz CW calibration signal (signal level is approximately  $-25.0$  dBm).
- **IF Align** - Select to view the IF alignment signal. This signal is available as a diagnostic function, to check the operation of the alignment signal in the case of alignment failure. Once selected, a menu accessing the IF alignment signal parameters is available at the bottom of the **Input** menu. Either CW, comb, or pulse signals may be selected. Because the alignment signal is input at the IF frequency, it is displayed on any active Spectrum (Freq Domain) window, regardless of center frequency.
- **Baseband Align Signal** - Select **On** to view the baseband alignment signal. This is available as a diagnostic function, to check the operation of the alignment signal in the case of alignment failure. Because the alignment signal is input at the IF frequency, it is displayed on any Spectrum (Freq Domain) window.

## Setting Up Baseband I/Q Inputs

Option B7C adds two keys that let you adjust the I/Q inputs; the **I/Q Setup** key and the **I/Q Range** key. Both keys are located under the **Input/Output** front panel key, or in the **Input** menu under the **Mode Setup** key.

The **I/Q Range** key lets you select one of four levels as an upper limit for the signal being applied to the baseband I/Q inputs. The level may be selected in units of dBm, dBmV, dBμV, V, and W. The following table shows the four-level selections available for each unit of measure: The default is 1 V.

The **I/Q Range** power levels in [Table 4-20](#) are based on an **I/Q Input Z** of 50Ω. **I/Q Range** voltage levels are independent of **I/Q Input Z**.

Table 4-20

**I/Q Range Settings by Displayed Unit of Measure**

Unit of Measure	Highest Setting			Lowest Setting
dBm	13.0	7.0	1.0	-5.1
dBmV	60	54	48	41.9
dBμV	120.0	114.0	108	101.9
V	1.000	500 m	250 m	125 m
W	20.0 m	5.0 m	1.2 m	310.0 μ

If **I/Q Range** is set below the default and the error message “Input Overload” is displayed, this value may be adjusted to its maximum. Beyond that point, the signal must be attenuated to preserve the measurement accuracy. Using a lower value than the default can provide an increased dynamic measurement range.

**I/Q Setup** lets you adjust the following:

- **I Offset** - Use to enter a voltage value to offset the measured I value. The default value is 0.0000 V. The range is -2.5600 to +2.5600 V. The tuning increment depends on the **I/Q Range** setting as shown in [Table 4-21](#). This value only affects the displayed results, and does not appear as a correcting voltage at the probe.

Table 4-21

**I and Q Offset Increment vs. I/Q Range**

I/Q Range	I and Q Offset Increment
1 V	2 mV
500 mV	1 mV
250 mV	.5 mV

Table 4-21

I and Q Offset Increment vs. I/Q Range

I/Q Range	I and Q Offset Increment
125 mV	.25 mV

- **Q Offset** - Use to enter a voltage value to offset the measured Q value. The default value is 0.0000 V. The range is -2.5600 to +2.5600 V. The tuning increment depends on the **I/Q Range** setting as shown in [Table 4-21](#). This value only affects the displayed results, and does not appear as a correcting voltage at the probe.
- **I/Q Input Z** - Allows you to access a menu to select an input impedance for baseband I/Q input signals. The selection of input impedance is coupled to a connector “balance” configuration. If **I/Q Input Z** is set to 1 M $\Omega$ , the setting for **I/Q Z Ref for Input Z = 1 M $\Omega$**  key becomes effective. For details, refer to “[Selecting Baseband I/Q Input Impedance](#)” on [page 247](#).
- **I/Q Z Ref for Input Z = 1 M $\Omega$**  - Allows you to select the 1 M $\Omega$  input reference Z value in Ohms. This key is effective only when **I/Q Input Z** is set to a 1 M $\Omega$  setting. The default value is 50.0  $\Omega$ . The range is 1.0  $\Omega$  to 10 M $\Omega$ , with a tuning increment of 1.0  $\Omega$ . For more details, refer to “[Selecting Baseband I/Q Input Impedance](#)” on [page 247](#).

Making Measurements

Figure 4-30

Input Menu with Option B7C Baseband I/Q Inputs

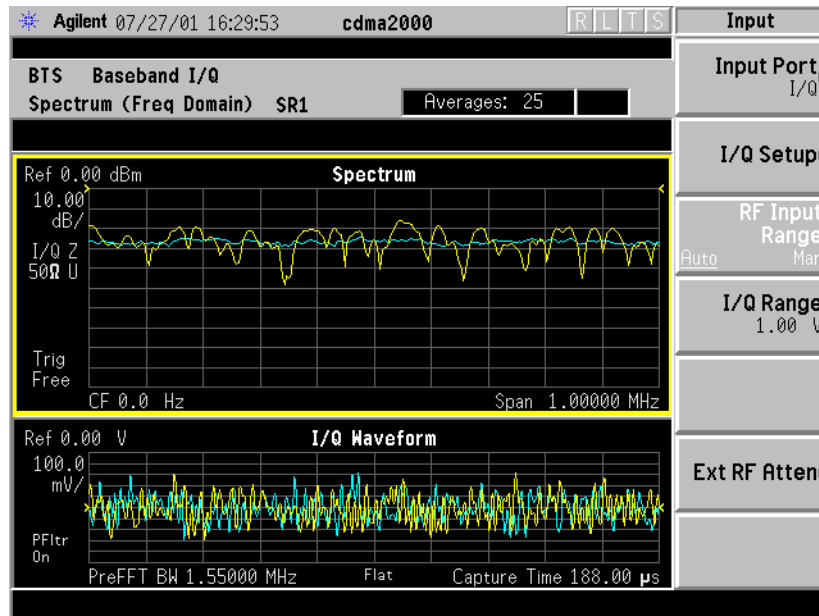

cdma2000 (Rev.8) Downlink, SR3 9 Channel, Baseband I/Q Inputs

**Figure 4-31 I/Q Setup Menu with Option B7C Baseband I/Q Inputs**

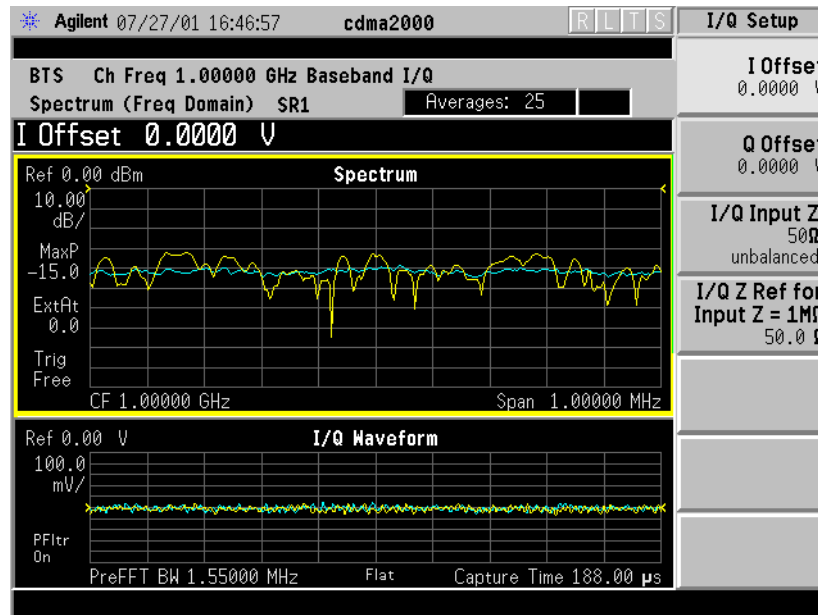

cdma2000 (Rev.8) Downlink, SR3 9 Channel, Baseband I/Q Inputs

### Selecting Baseband I/Q Input Impedance

The selection of input impedance is coupled to a connector “balance” configuration. “Balance” refers to whether an input is “single-ended” (unbalanced) or is balanced.

To select an input impedance, press **Input/Output**, **I/Q Setup**, **I/Q Input Z** to display the following choices:

- **50 Ω Unbalanced** - Select to use I and/or Q input connectors.
- **600 Ω Balanced** - Select to use either I and  $\bar{I}$ , Q and  $\bar{Q}$ , or all four I, Q,  $\bar{I}$ , and  $\bar{Q}$  input connectors.
- **1 MΩ Unbalanced** - This is the default input connector setting. Select to use I and/or Q input connectors in an unbalanced mode. When **I/Q Input Z** is set to 1 MΩ (either balanced or unbalanced), the setting for **I/Q Z Ref for Input Z = 1 MΩ** key may be adjusted. Otherwise, the default value for **I/Q Z Ref = 1 MΩ** is 50 Ω.
- **1 MΩ Balanced** - Select to use either I and  $\bar{I}$ , Q and  $\bar{Q}$ , or all four I, Q,  $\bar{I}$ , and  $\bar{Q}$  input connectors to make a balanced measurement. When **I/Q Input Z** is set to 1 MΩ (either balanced or unbalanced), the setting for **I/Q Z Ref for Input Z = 1 MΩ** key may be adjusted. Otherwise, the default value for **I/Q Z Ref for Input Z = 1 MΩ** is 50 Ω.

Figure 4-32 I/Q Input Z Menu - Option B7C Baseband I/Q Inputs

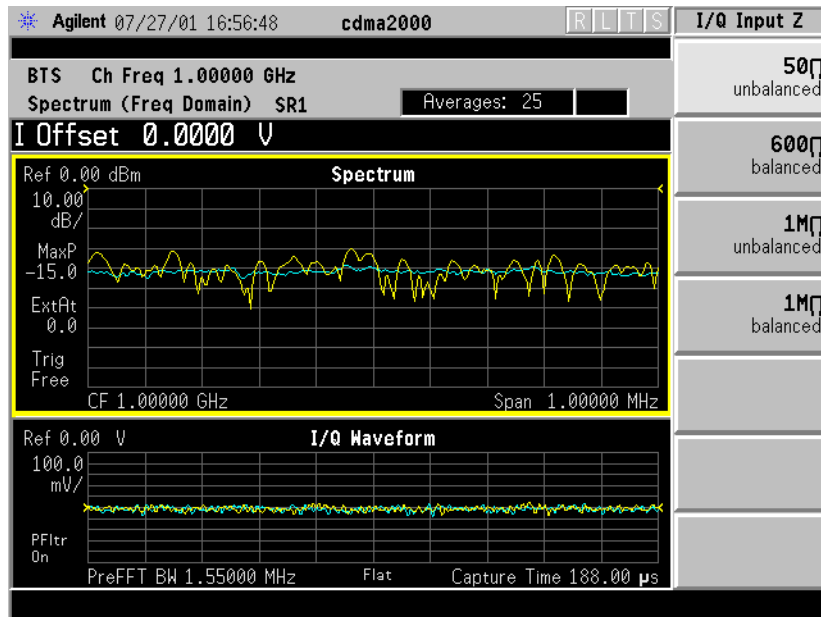

cdma2000 (Rev.8) Downlink, SR3 9 Channel, Baseband I/Q Inputs

## Baseband I/Q Measurement Views

Measurement result views made in the Basic mode, or by other compatible optional personalities, are available for baseband signals if they relate to the nature of the signal itself. Many measurements which relate to the characteristics baseband I and Q signals have when mixed and upconverted to signals in the RF spectrum can be made as well. However, measurements which relate to the characteristics of an upconverted signal that lie beyond the bandwidth available to the Baseband I/Q Input circuits can not be measured (the limits are up to 5 MHz bandwidth for individual I and Q signals, and up to 10 MHz for composite I/Q signals).

Some measurement views are appropriate for use with both RF and baseband I/Q signals without any modification, while other views must be altered. Some examples of measurements with identical results views are QPSK EVM, Code Domain, and CCDF. For Spectrum measurements, identical views include the I and Q Waveform view and the I/Q Polar view. For Waveform measurements, identical views include the I/Q Waveform view, the Signal Envelope view, and the I/Q Polar view.

At RF frequencies, power measurements are conventionally displayed on a logarithmic vertical scale in dBm units, whereas measurements of baseband signals using Baseband I/Q inputs may be conveniently displayed as voltage using a linear vertical scale as well as a log scale.



### Spectrum Views and 0 Hz Center Frequency

Some views must be altered to account for the fundamental difference between RF and baseband I/Q signals. For Spectrum measurements of I/Q signals this includes using a center frequency of 0 Hz for Spectrum views and the Spectrum Linear view. Occupied Bandwidth and Channel Power results are also displayed using a center frequency of 0 Hz.

The center frequency of baseband I/Q Spectrum displays is 0 Hz. Frequencies higher than 0 Hz are displayed as “positive” and those below 0 Hz are “negative”. The “negative” portion of a multi-channel baseband signal below 0 Hz corresponds to the portion of the signal that would lie below the carrier center frequency when it is upconverted, if no spectral inversion occurs. As 0 Hz is a fixed center frequency, the **FREQUENCY Channel** front-panel key has no active menu for baseband I/Q Spectrum measurements.

To view the Spectrum display of I only or Q only signals, use the Spectrum measurement capability in Basic Mode.

### Waveform Views for Baseband I/Q Inputs

For Waveform measurements, two new displays are available exclusively for baseband I/Q input signals; the I and Q Waveform view, which separates the individual I and Q traces, and the I/Q Polar view. Since the horizontal axis for Waveform measurements is Time, the **FREQUENCY Channel** front-panel key has no active menu for baseband I/Q Waveform measurements. Use **Span** to change horizontal scale. A **Linear Envelope** view is also available to display baseband signals that employs linear voltage units on the vertical axis.

### Waveform Signal Envelope Views of I only or Q only

To view the Signal Envelope display of I only or Q only signals, use the Waveform measurement capability in Basic Mode.

### Comparing RF and Baseband I/Q Measurement Views

The following table compares the measurement views for RF inputs and baseband I/Q inputs.

**Table 4-22 RF vs. Baseband I/Q Input Measurement Views by Measurement**

Measurement	Views for RF Input Measurements	Views for Baseband I/Q Inputs Measurements	Mods to RF View for Baseband I/Q Inputs
Channel Power	Channel Power	Channel Power	Center Freq = 0 Hz
ACPR	FFT, Fast Bar Graph, Spectrum	Measurement Not Available	n/a

**Table 4-22 RF vs. Baseband I/Q Input Measurement Views by Measurement**

Measurement	Views for RF Input Measurements	Views for Baseband I/Q Inputs Measurements	Mods to RF View for Baseband I/Q Inputs
Intermodulation	IMD Spectrum	Measurement Not Available	n/a
Spectrum Emission Mask	Spectrum Views by Offset	Measurement Not Available	n/a
Occupied BW	Occupied BW	Occupied BW	Center Freq = 0 Hz
Code Domain	Power Graph & Metrics I/Q Error (Quad View) Code Domain (Quad View) Demod Bits table	Power Graph & Metrics I/Q Error (Quad View) Code Domain (Quad View) Demod Bits table	none
Mod Accuracy (Composite RHO)	I/Q Measured Polar Vector I/Q Measured Polar Constln I/Q Error (Quad View) Power Timing and Phase	I/Q Measured Polar Vector I/Q Measured Polar Constln I/Q Error (Quad View) Power Timing and Phase	none
QPSK EVM	I/Q Measured Polar Vector I/Q Measured Polar Constln I/Q Error (Quad View)	I/Q Measured Polar Vector I/Q Measured Polar Constln I/Q Error (Quad View)	none
Power Stat CCDF	CCDF	CCDF	none
Spectrum (Freq Domain)	Spectrum Spectrum Linear I and Q Waveform I/Q Polar	Spectrum Spectrum Linear I and Q Waveform I/Q Polar	Center Freq = 0 Hz (Spectrum Views) Y axis = V, dBm (Spectrum Linear)
Waveform (Time Domain)	Signal Envelope I/Q Waveform I/Q Polar	Signal Envelope I/Q Waveform I/Q Polar Linear Envelope I and Q Waveform	Y axis = V, dBm (Linear Envelope)

Results screens for the above measurements unique to baseband I/Q inputs are shown in the section “[Baseband I/Q Measurement Result Examples](#)” on page 250.

### Baseband I/Q Measurement Result Examples

The following sections show examples of new measurement result displays using baseband I/Q Inputs. A notation below each example

indicates the nature of the input signal.

### Channel Power Measurement

There is a new view for Channel Power measurements with baseband I/Q Inputs: the Channel Power Spectrum view with 0 Hz center frequency.

Figure 4-33

### cdma2000 Channel Power - Baseband I/Q Inputs

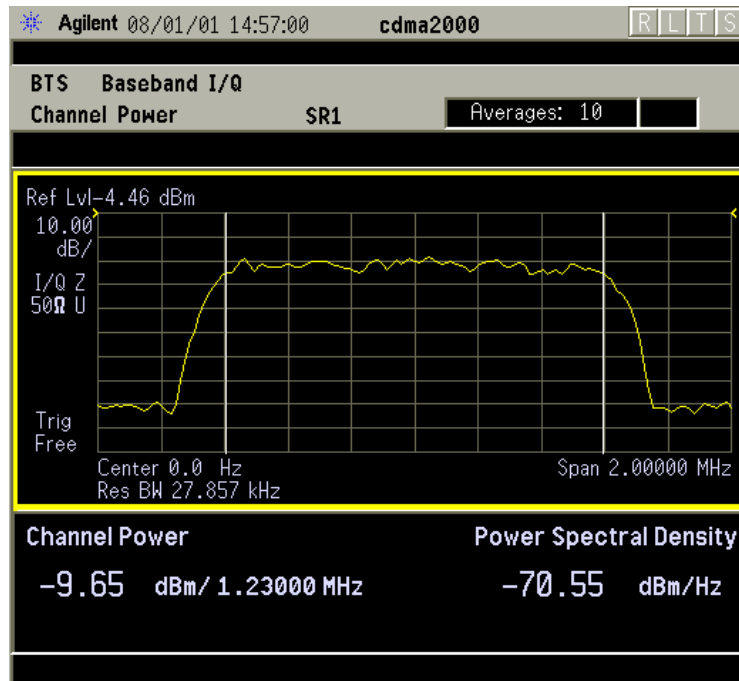

Making Measurements

cdma2000 (Rev.8) Downlink, SR3 9 Channel, Baseband I/Q Inputs

### Occupied Bandwidth Measurement

There is one new view for Occupied Bandwidth measurements with baseband I/Q Inputs: the Occupied BW Spectrum view with 0 Hz center frequency.

Figure 4-34

**cdma2000 Occupied Bandwidth - Baseband I/Q Inputs**

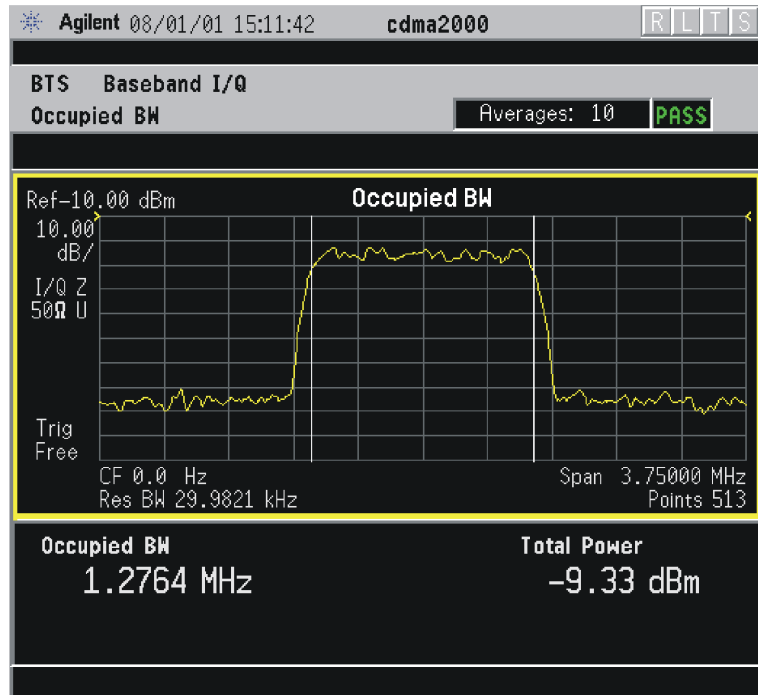

cdma2000 (Rev.8) Downlink, SR1 9 Channel, Baseband I/Q Inputs

**Spectrum (Frequency Domain) Measurement**

There are two new views with baseband I/Q input Spectrum measurements: the Spectrum view with 0 Hz center frequency, and the Spectrum Linear view with 0 Hz center frequency and the vertical scale in volts.

**Figure 4-35** cdma2000 Spectrum View - Baseband I/Q Inputs

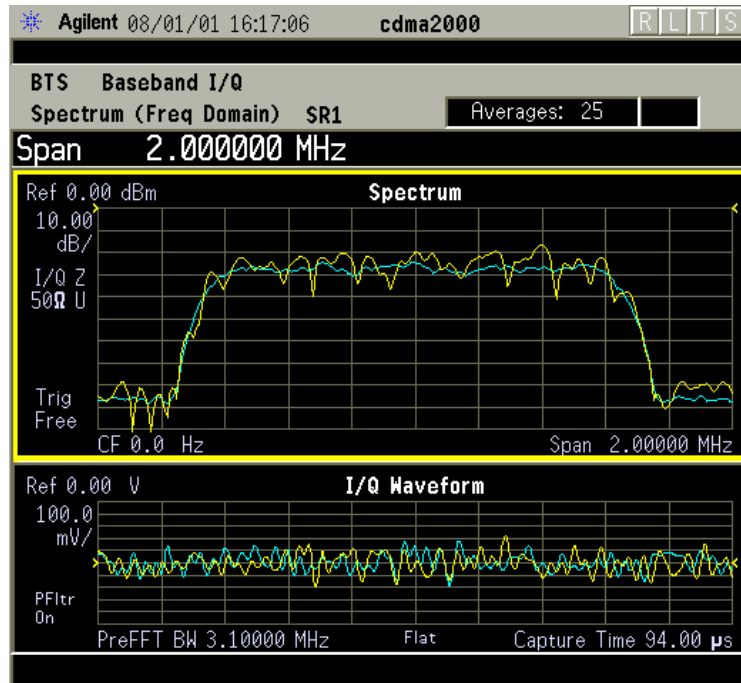

cdma2000 (Rev.8) Downlink, SR1 9 Channel, Baseband I/Q Inputs

**Figure 4-36** cdma2000 Spectrum Linear View - Baseband I/Q Inputs

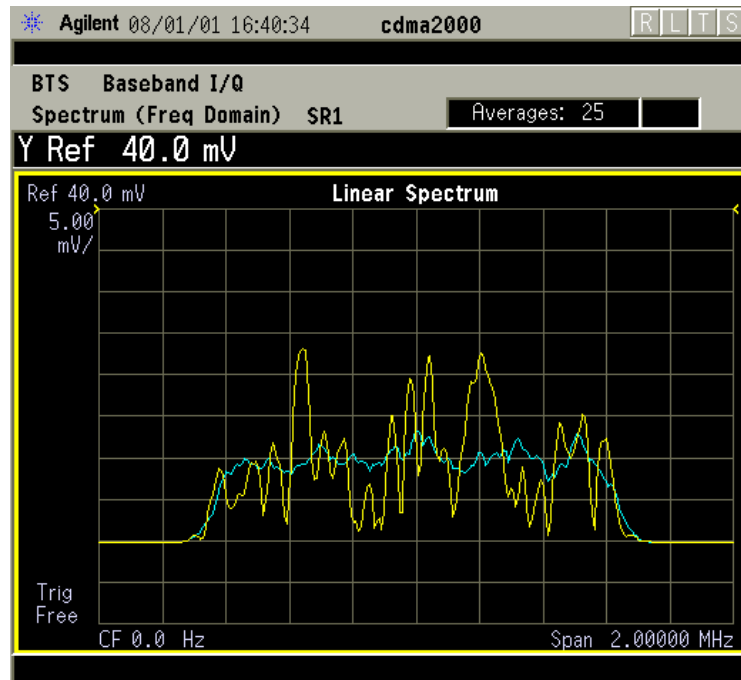

cdma2000 (Rev.8) Downlink, SR1 9 Channel, Baseband I/Q Inputs

Making Measurements

### Waveform (Time Domain) Measurement

There are two new views with baseband I/Q input Waveform (Time Domain) measurements: the Linear Envelope view with the vertical scale in volts, and the I and Q Waveform view with separate windows for the I and Q traces.

Figure 4-37

cdma2000 Waveform Linear Envelope - Baseband I/Q Inputs

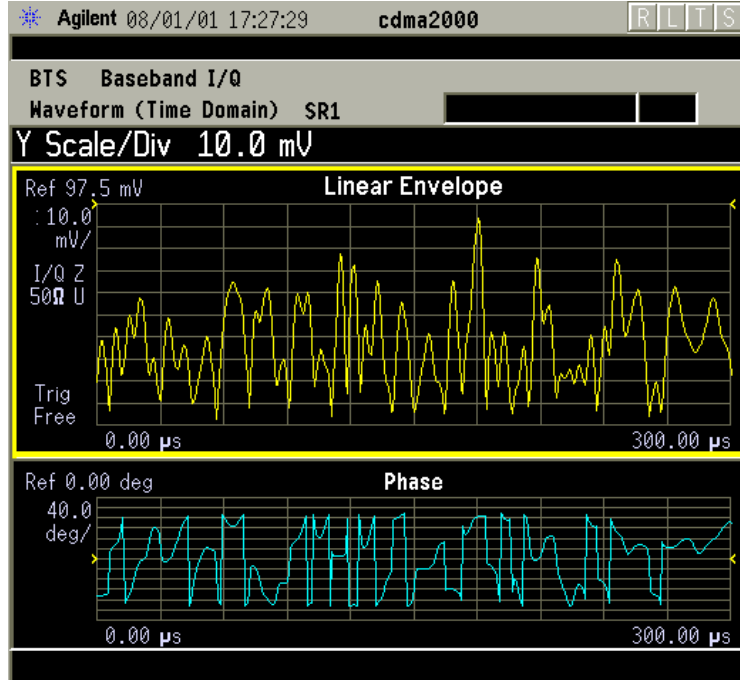

cdma2000 (Rev.8) Downlink, SR1 9 Channel, Baseband I/Q Inputs

Figure 4-38 cdma2000 I and Q Waveform View - Baseband I/Q Inputs

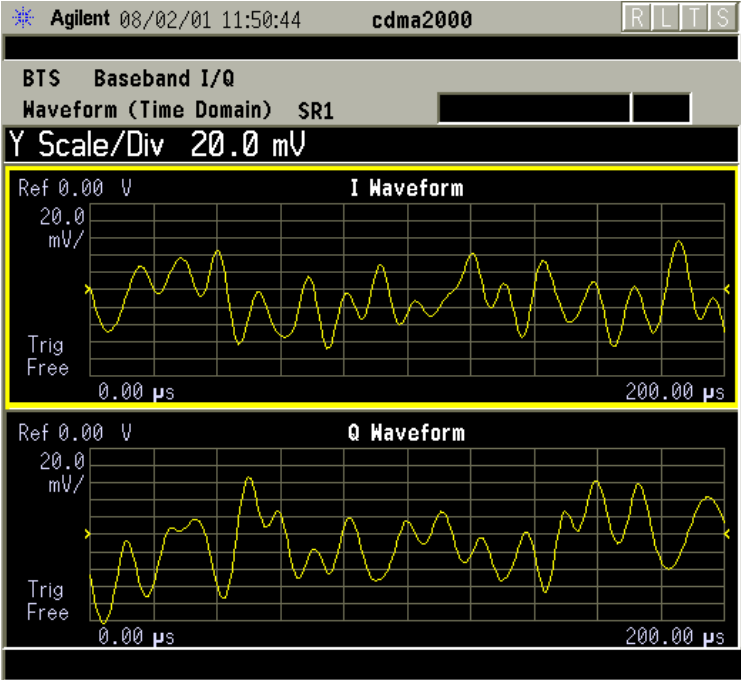

cdma2000 (Rev.8) Downlink, SR1 9 Channel, Baseband I/Q Inputs

Making Measurements

## Baseband I/Q Key Access Locations

All baseband I/Q input setup and operation features can be located by using the key access table below. The key access path shows the key sequence you enter to access a particular key.

Some features can only be used when specific measurements are active. If a feature is not currently valid the key label for that feature appears as lighter colored text or is not displayed at all.

Table 4-23

Baseband I/Q Key Access Locations

Key	Key Access Path
Align IQ	System>Alignments>Align Subsystem>
Baseband Align Signal	Mode Setup>Input>Input Port>
dBm	Input/Output>I/Q Range>
dBm	Mode Setup>Input>I/Q Range>
dBmv	Input/Output>I/Q Range>
dBmv	Mode Setup>Input>I/Q Range>
dBuv	Input/Output>I/Q Range>
dBuv	Mode Setup>Input>I/Q Range>
I and Q Waveform	View/Trace> (Waveform Measurement)
I Offset	Input/Output>I/Q Setup>
I Offset	Mode Setup>Input>I/Q Setup>
I/Q	Input/Output>Input Port>
I/Q	Mode Setup>Input>Input Port>
I/Q Input Z	Input/Output>I/Q Setup>
I/Q Input Z	Mode Setup>Input>I/Q Setup>
I/Q Polar	View/Trace>
I/Q Range	Input/Output>
I/Q Range	Mode Setup>Input>
I/Q Setup	Input/Output>
I/Q Setup	Mode Setup>Input>
I/Q Waveform	View/Trace>
I/Q Waveform	Marker>Trace>
I/Q Z Ref for Input Z = 1 MΩ	Mode Setup>Input>I/Q Setup>
I Waveform	View/Trace> (Spectrum Measurement)



Table 4-23

Baseband I/Q Key Access Locations

Key	Key Access Path
Linear Envelope	View/Trace> (Waveform Measurement)
Q Offset	Input/Output>Input>I/Q Setup>
Q Offset	Mode Setup>Input>I/Q Setup>
Q Waveform	Marker>Trace>
Signal Envelope	View/Trace> (Waveform Measurement)
Spectrum Linear	View/Trace> (Spectrum Measurement)
V(olts)	Mode Setup>Input>I/Q Setup>I Offset (or Q Offset)>Keypad Entry
Volts	Input/Output>I/Q Range>
Volts	Mode Setup>Input>I/Q Range>
Watts	Input/Output>I/Q Range>
Watts	Mode Setup>Input>I/Q Range>

## BbIQ Programming Commands

This is a summary of the SCPI commands related to the operation of Option B7C Baseband I/Q Inputs. For complete programming information refer to the Language Reference chapter in the Programmer's Guide and the Programming Commands chapter in the cdma2000 Guide.

### CALCulate Subsystem

#### Baseband I/Q - Spectrum I/Q Marker Query

```
:CALCulate:SPECTrum:MARKer:IQ [1] | 2 | 3 | 4?
```

Reads out current I and Q marker values.

#### Baseband I/Q - Waveform I/Q Marker Query

```
:CALCulate:WAVEform:MARKer:IQ [1] | 2 | 3 | 4?
```

Reads out current I and Q marker values.

### CALibration Subsystem

#### Baseband I/Q - Align the Baseband IQ

```
:CALibration:GIQ
```

```
:CALibration:GIQ?
```

Performs the IQ group of alignments. The query performs the

alignment and returns a 0 if the alignment is successful.

### **Baseband I/Q - IQ Common Mode Response Null**

```
:CALibration:IQ:CMR
```

```
:CALibration:IQ:CMR?
```

Forces a common mode response null on I/Q inputs.

### **Baseband I/Q - IQ Flatness Calibration**

```
:CALibration:IQ:FLATness
```

```
:CALibration:IQ:FLATness?
```

Activates a flatness calibration for all I/Q ranges and impedance settings.

### **Baseband I/Q - IQ Offset Calibration**

```
:CALibration:IQ:OFFSet
```

```
:CALibration:IQ:OFFSet?
```

Activates a calibration of the I/Q input offset DAC.

## **DISPlay Subsystem**

### **Spectrum - Y-Axis Scale/Div**

```
:DISPlay:SPECTrum[n] :WINDow[m] :TRACe:Y[:SCALe] :PDIVision  
<power>
```

```
:DISPlay:SPECTrum[n] :WINDow[m] :TRACe:Y[:SCALe] :PDIVision?
```

Sets the amplitude reference level for the horizontal axis.

### **Spectrum - Y-Axis Reference Level**

```
:DISPlay:SPECTrum[n] :WINDow[m] :TRACe:Y[:SCALe] :RLEVel  
<power>
```

```
:DISPlay:SPECTrum[n] :WINDow[m] :TRACe:Y[:SCALe] :RLEVel?
```

Sets the amplitude reference level for the horizontal axis.

### **Waveform - Y-Axis Scale/Div**

```
:DISPlay:WAVEform[n] :WINDow[m] :TRACe:Y[:SCALe] :PDIVision  
<power>
```

```
:DISPlay:WAVEform[n] :WINDow[m] :TRACe:Y[:SCALe] :PDIVision?
```

Sets the scale per division for the horizontal axis.

### **Waveform - Y-Axis Reference Level**

```
:DISPlay:WAVEform[n] :WINDow[m] :TRACe:Y[:SCALe] :RLEVel  
<power>
```

```
:DISPlay:WAVEform[n]:WINDow[m]:TRACe:Y[:SCALE]:RLEVel?
```

Sets the amplitude reference level for the horizontal axis.

### INPut Subsystem

The INPut subsystem controls the characteristics of all the instrument input ports.

#### Baseband I/Q - Select Input Impedance

```
:INPut:IMPedance:IQ U50|B600|U1M|B1M
```

```
:INPut:IMPedance:IQ?
```

Selects the characteristic input impedance when input port is set to I or Q. This is the impedance value as well as the unbalanced (U) or balanced (B) impedance mode.

#### Baseband I/Q - Select Input Impedance Reference

```
:INPut:IMPedance:REFerence <integer>
```

```
:INPut:IMPedance:REFerence?
```

Sets the value of the input impedance reference when input port is set to I or Q.

#### Baseband I/Q - Activate IQ Alignment

```
:INPut:IQ:ALIGn OFF|ON|0|1
```

```
:INPut:IQ:ALIGn?
```

Activates or deactivates IQ alignment.

#### Baseband I/Q - I Input DC Offset

```
:INPut:OFFSet:I <level>
```

```
:INPut:OFFSet:I?
```

Sets adjustment to compensate for I voltage bias on signals when the I input port is selected.

#### Baseband I/Q - Q Input DC Offset

```
:INPut:OFFSet:Q <level>
```

```
:INPut:OFFSet:Q?
```

Sets adjustment to compensate Q voltage bias on signals when the Q input port is selected.

### MEASure Subsystem

**Spectrum (Frequency Domain) Measurement** This measures the amplitude of your input signal with respect to the frequency. It provides

spectrum analysis capability using FFT (fast Fourier transform) measurement techniques. You must select the appropriate mode using INSTRUMENT:SELEct, to use these commands.

```
:CONFigure:SPECTrum  
:FETCh:SPECTrum [n] ?  
:INITiate:SPECTrum  
:READ:SPECTrum [n] ?  
:MEASure:SPECTrum [n] ?
```

**Waveform (Time Domain) Measurement** This measures the power in your input signal with respect to time and is equivalent to zero-span operation in a traditional spectrum analyzer. You must select the appropriate mode using INSTRUMENT:SELEct, to use these commands.

```
:CONFigure:WAVEform  
:FETCh:WAVEform [n] ?  
:READ:WAVEform [n] ?  
:MEASure:WAVEform [n] ?
```

## SENSE Subsystem

### Select the Input Signal

```
[ :SENSE ] :FEED RF | IQ | IONLY | QONLY | AREFERENCE | IFALIGN  
[ :SENSE ] :FEED?
```

Selects the input signal. The default input signal is taken from the front panel RF input port. For calibration and testing purposes the input signal can be taken from an internal 321.4 MHz IF alignment signal or an internal 50 MHz amplitude reference source.

If the baseband IQ option (Option B7C) is installed, I and Q input ports are added to the front panel. The I and Q ports accept the in-phase and quadrature components of the IQ signal, respectively. The input signal can be taken from either or both ports.

RF selects the signal from the front panel RF INPUT port.

IQ selects the combined signals from the front panel optional I and Q input ports.

IONLY selects the signal from the front panel optional I input port. (available in the Basic mode)

QONLY selects the signal from the front panel optional Q input port. (available in the Basic mode)

AREFERENCE selects the internal 50 MHz amplitude reference signal.

IFALign selects the internal, 321.4 MHz, IF alignment signal.

### Baseband I/Q - Select I/Q Power Range

```
[ :SENSE ] :POWER:IQ:RANGE [:UPPER] <power> [DBM] |DBMV|W
```

```
[ :SENSE ] :POWER:IQ:RANGE [:UPPER] ?
```

Selects maximum total power expected from unit under test at test port when I or Q port is selected.

### Baseband I/Q - Select I/Q Voltage Range

```
[ :SENSE ] :VOLTage:IQ:RANGE [:UPPER] <level>
```

```
[ :SENSE ] :VOLTage:IQ:RANGE [:UPPER] ?
```

Selects upper voltage range when I or Q port is selected. This setting helps set the gain which is generated in the variable gain block of the baseband IQ board to improve dynamic range.



---

# 5

## Programming Commands

These commands are only available when the cdma2000 mode has been selected using **INSTRument:SElect CDMA2K**. If this mode is selected, commands that are unique to another mode are not available.

## SCPI Command Subsystems

- “CALCulate Subsystem” on page 270
- “CONFigure Subsystem” on page 298
- “DISPlay Subsystem” on page 299
- “FETCh Subsystem” on page 309
- “FORMat Subsystem” on page 310
- “INITiate Subsystem” on page 312
- “INSTrument Subsystem” on page 315
- “MEASure Group of Commands” on page 318
- “READ Subsystem” on page 377
- “SENSe Subsystem” on page 378
- “TRIGger Subsystem” on page 479



## Programming Command Compatibility Across Model Numbers and Across Modes

### Across PSA Modes: Command Subsystem Similarities

When you select different modes you get different sets of available programming commands. That is, *only* the commands that are appropriate for the current mode are available. Also, some commands have the same syntax in different modes but have different ranges or settings that are only appropriate to the current mode.

The following table shows which command subsystems are the same across different modes. If there is no “X” by a particular subsystem, then the set of available commands is different in those modes. Command ranges or defaults may also be different. Refer to the programming command descriptions in the documentation for each mode for details.

Command Subsystem	Same command set is available:  SA mode compared with the application modes: W-CDMA, cdmaOne, cdma2000, 1xEV-DO, Basic, GSM, EDGE, NADC, or PDC	Same command set is available:  SA mode compared with the application mode: Phase Noise
IEEE common commands	X	X
ABORt	X	X
CALCulate		
CALibration	X	X
CONFigure		
COUPlE	not available in these application modes	not available in this application modes
DISPlay		
FETCh		
FORMat		X
HCOPy	X	X
INITiate		
INPut	not available in these application modes	X

Command Subsystem	Same command set is available:  SA mode compared with the application modes: W-CDMA, cdmaOne, cdma2000, 1xEV-DO, Basic, GSM, EDGE, NADC, or PDC	Same command set is available:  SA mode compared with the application mode: Phase Noise
MEASure		
MEMory	X	X
MMEMory	X	X
MMEMory:STORe:TRACe	not available in application modes	X
READ		
[SENSe] [SENSe:]CHANnel [SENSe:]CORRection [SENSe:]FEED [SENSe:]FREQUency:CENTer [SENSe:]FREQUency: <other subsystems> [SENSe:]<measurement> [SENSe:]POWer [SENSe:]RADio [SENSe:]SYNC	X  not available in application modes	  not available in application modes
STATus	X	X
SYSTem	X	X
TRACe	not available in application modes	X
TRIGger		
UNIT	X	X

## Across PSA Modes: Specific Command Differences

Some programming commands operate differently depending on which Mode the analyzer is set to.

Command	Spectrum Analysis, Phase Noise and Noise Figure Mode	Basic, cdmaOne, cdma2000, 1xEV-DO, W-CDMA, GSM, EDGE, NADC, PDC Modes
CONFigure: <measurement>	Accesses the measurement and sets the instrument settings to the defaults. Averaging is turned on and set to 10. The instrument is put in single measurement mode. It does not initiate a measurement. Use INIT:IMM to make one measurement.	Accesses the measurement and sets the instrument settings to the defaults. If you were already in single measurement mode, it takes one measurement and then waits. If you were in continuous measurement mode it continues to measure.
*ESE default	Default is 255 which means that every error/status bit change that has occurred will be returned with a *ESR? query. You must set the value of *ESE to choose only the bits/status that you want returned.	Default is 0 which means that none of the error/status bit changes that have occurred will be returned with a *ESR? query. You must set the value of *ESE to choose the bits/status that you want returned.
TRIGger commands	For these modes, only one trigger source can be selected and it will be common across the modes. Also, only one value can be set for the trigger delay, level, or polarity.	For these modes, a unique trigger source can be selected for each mode. Also, each trigger source can have unique settings for the its delay, level, and polarity.
Saving and recalling traces	Traces can only be saved when in the Spectrum Analysis mode (MMEM:STOR:TRAC). This is because the instrument state must be saved along with the trace data and the state data varies depending on the number of modes currently available in the instrument.	

## Using Applications in PSA Series vs. VSA E4406A

**NOTE**

This information *only* applies to the application modes:  
Basic, cdmaOne, cdma2000, 1xEV-DO, W-CDMA, GSM, EDGE,  
NADC, and PDC.

Command	PSA Series	VSA E4406A: A.04.00	VSA E4406A: A.05.00
*RST	Resets instrument, putting it in continuous measurement mode. Use INIT:CONT OFF to select single measurement mode and INIT:IMM to start one measurement.	Resets instrument, putting it in single measurement mode. One measurement is initiated when the command is sent.	Resets instrument, putting it in single measurement mode. No measurement is initiated when the command is sent. Use INIT:IMM to start one measurement.
CONFigure: <measurement>	Accesses the measurement and sets the instrument settings to the defaults. If you were already in single measurement mode, it takes one measurement and then waits.	Same as PSA.  Accesses the measurement and sets the instrument settings to the defaults. If you were already in single measurement mode, it takes one measurement and then waits.	Accesses the measurement and sets the instrument settings to the defaults. If you were already in single measurement mode, it does not initiate a measurement. Use INIT:IMM to make one measurement.
*ESE default	Default is 255 which means that every error/status bit change that has occurred will be returned with a *ESR? query. You must set the value of *ESE to choose only the bits/status that you want returned.	Default is 0 which means that none of the error/status bit changes that have occurred will be returned with a *ESR? query. You must set the value of *ESE to choose the bits/status that you want returned.	Same as VSA A.04.00.  Default is 0 which means that none of the error/status bit changes that have occurred will be returned with a *ESR? query. You must set the value of *ESE to choose the bits/status that you want returned.
*LRN	The command is <i>not</i> available.	The command is available.	The command is available.
TRIGger commands	In Spectrum Analysis mode only one value can be set for the trigger's source, delay, level, or polarity.  Basic, GSM, EDGE, cdmaOne, cdma2000, W-CDMA, NADC, PDC modes function the same as VSA	You can select a unique trigger source for each mode. Each trigger source can have unique settings for the its delay, level, and polarity.	Same as VSA A.04.00.  You can select a unique trigger source for each mode. Each trigger source can have unique settings for the its delay, level, and polarity.

Command	PSA Series	VSA E4406A: A.04.00	VSA E4406A: A.05.00
<p>AUTO ON   OFF control and setting manual values</p>	<p>We recommend that you set a function's automatic state to OFF, before you send it your manual value.</p> <p>Some functions will turn off the automatic mode when you send a specific manual value, but others will not. This also varies with the instrument model.</p>	<p>We recommend that you set a function's automatic state to OFF, before you send it your manual value.</p> <p>Some functions will turn off the automatic mode when you send a specific manual value, but others will not. This also varies with the instrument model.</p>	<p>We recommend that you set a function's automatic state to OFF, before you send it your manual value.</p> <p>Some functions will turn off the automatic mode when you send a specific manual value, but others will not. This also varies with the instrument model.</p>

---

## CALCulate Subsystem

This subsystem is used to perform post-acquisition data processing. In effect, the collection of new data triggers the CALCulate subsystem. In this instrument, the primary functions in this subsystem are markers and limits.

The SCPI default for data output format is ASCII. The format can be changed to binary with FORMat:DATA which transports faster over the bus.

### Code Domain Power - Limits

#### Code Domain—Active Set Threshold

```
:CALCulate:CDPower:ASET:THReshold <numeric>
```

```
:CALCulate:CDPower:ASET:THReshold?
```

Set the threshold level for the active channel identification function.

Factory Preset: 0.0 dBm

Range: -100.0 to 0.0 dB

Remarks: You must be in the cdma2000, W-CDMA, or 1xEV-DO mode to use this command. Use INSTRument:SElect to set the mode.

#### Code Domain—Active Set Threshold Mode

```
:CALCulate:CDPower:ASET:THReshold:AUTO OFF|ON|0|1
```

```
:CALCulate:CDPower:ASET:THReshold:AUTO?
```

Turn the automatic mode On or Off, for the active channel identification function.

OFF – The active channel identification for each code channel is determined by a value set by CALCulate:CDPower:ASET:THReshold.

ON – The active channels are determined automatically with the internal algorithm.

Factory Preset: ON

Remarks: You must be in the cdma2000, W-CDMA, or 1xEV-DO mode to use this command. Use INSTRument:SElect to set the mode.

### Code Domain—Decode Axis

**:CALCulate:CDPower:AXIS[:MS] IPH|QPH**

**:CALCulate:CDPower:AXIS[:MS] ?**

Select the I phase or Q phase for the demodulation axis. (For MS only)

IPH – I phase

QPH – Q phase

Factory Preset: IPH for cdma2000

QPH for W-CDMA

Remarks: You must be in the cdma2000 or W-CDMA mode to use this command. Use INSTRument:SElect to set the mode.

### Code Domain — Psuedo-Random Noise Offset

**:CALCulate:CDPower:PNOffset <time>**

**:CALCulate:CDPower:PNOffset?**

Sets value for the psuedo-random noise offset. Different psuedo-random noise offsets are used for different base stations. By setting the pseudo-random noise offset to the value that your specific base station is set to, you get the correct time offset value displayed and returned back to you when you query READ:RHO? The instrument, by default, assumes an offset of 0. So if you do not use this command you will have to manually calculate the time offset when the value is other than 0.

Factory Preset: 0 chips offset

Range: 0 to 511 (× 64 chips) 1 = 64 chip offset, 2 = 128 chips

Remarks: You must be in the cdma2000 mode to use this command. Use INSTRument:SElect to set the mode.

### Code Domain—Sweep Offset (Measurement Offset)

**:CALCulate:CDPower:SWEep:OFFSet <integer>**

**:CALCulate:CDPower:SWEep:OFFSet?**

cdma2000, 1xEV-DO modes:

Set the timing offset of measurement interval in the unit of Power Control Group (PCG; 1 PCG = 1.25 ms).

The sum of **CALCulate:CDPower:SWEep:TIME** and **CALCulate:CDPower:SWEep:OFFSet** must be equal to or less than **SENSe:CDPower:CAPTure:TIME**. If the sum becomes more than the

value, `CALCulate:CDPower:SWEep:OFFSet` is adjusted automatically.

W-CDMA mode:

Set the timing offset of measurement interval in slots (1 slot = 625  $\mu$ s).

The sum of `CALCulate:CDPower:SWEep:TIME` and `CALCulate:CDPower:SWEep:OFFSet` must be equal to or less than `SENSe:CDPower:CAPTure:TIME`  $\times$  15. If the sum becomes more than the value, `CALCulate:CDPower:SWEep:OFFSet` is adjusted automatically.

Factory Preset: 0

Range: 0 to `SENSe:CDPower:CAPTure:TIME` - 1 for cdma2000, 1xEV-DO

0 to `SENSe:CDPower:CAPTure:TIME`  $\times$  15 - 1 for W-CDMA

Remarks: You must be in the cdma2000, W-CDMA, or 1xEV-DO mode to use this command. Use `INSTRument:SELEct` to set the mode.

### Code Domain—Sweep Time (Measurement Interval)

`:CALCulate:CDPower:SWEep:TIME` <integer>

`:CALCulate:CDPower:SWEep:TIME?`

- For cdma2000, 1xEV-DO

Set the length of measurement interval in the unit of Power Control Group (PCG; 1 PCG = 1.25 ms).

The sum of `CALCulate:CDPower:SWEep:TIME` and `CALCulate:CDPower:SWEep:OFFSet` must be equal to or less than `SENSe:CDPower:CAPTure:TIME`. If the sum becomes more than the value, `CALCulate:CDPower:SWEep:OFFSet` is adjusted automatically.

- For W-CDMA

Set the length of measurement interval in slots (1 slot = 625  $\mu$ s).

The sum of `CALCulate:CDPower:SWEep:TIME` and `CALCulate:CDPower:SWEep:OFFSet` must be equal to or less than `SENSe:CDPower:CAPTure:TIME`  $\times$  15. If the sum becomes more than the value, `CALCulate:CDPower:SWEep:OFFSet` is adjusted automatically.

Factory Preset: 1



Range: 1 to `SENSe:CDPower:CAPTure:TIME` for cdma2000, 1xEV-DO  
1 to `SENSe:CDPower:CAPTure:TIME` × 15 for W-CDMA

Remarks: You must be in the cdma2000, W-CDMA, or 1xEV-DO mode to use this command. Use `INSTRument:SElect` to set the mode.

### Code Domain—Computation Type

`:CALCulate:CDPower:TYPE ABSolute|RELative`

`:CALCulate:CDPower:TYPE?`

Set the code domain power computation type to either the absolute power or the relative value to the mean power.

ABSolute – code domain power is computed as the absolute power.

RELative – code domain power is computed relative to the mean power.

Factory Preset: RELative

Remarks: You must be in the cdma2000, W-CDMA, or 1xEV-DO mode to use this command. Use `INSTRument:SElect` to set the mode.

### Code Domain—Walsh Code Base Length

`:CALCulate:CDPower:WCODE:BASE <integer>`

`:CALCulate:CDPower:WCODE:BASE?`

Set the Walsh Code base length for BTS. (For MS, this value is always 32.)

Factory Preset: 64

Range: 64, 128

Remarks: You must be in the cdma2000 mode to use this command. Use `INSTRument:SElect` to set the mode.

### Code Domain—Walsh Code Length

`:CALCulate:CDPower:WCODE:LENGth <integer>`

`:CALCulate:CDPower:WCODE:LENGth?`

Set the Walsh Code length.

Factory Preset: 64 for BTS  
32 for MS

Range: 4, 8, 16, 32, 64, 128 for BTS  
2, 4, 8, 16, 32 for MS

Remarks: You must be in the cdma2000 mode to use this command. Use INSTRument:SElect to set the mode.

### Code Domain—Walsh Code Number

`:CALCulate:CDPower:WCODE[:NUMBER] <integer>`

`:CALCulate:CDPower:WCODE[:NUMBER]?`

Set the Walsh code number depending on the channel type.

Factory Preset: 0

Range: 0 to `CALCulate:CDPower:WCODE:LENGTH - 1`, for cdma2000  
0 to 31 for Pilot,  
0 to 63 for MAC,  
0 to 15 for Data (1xEV-DO)

Remarks: You must be in the cdma2000 or 1xEV-DO mode to use this command. Use INSTRument:SElect to set the mode.

### Code Domain—Walsh Code Order

`:CALCulate:CDPower:WCODE:ORDER BREverse|HADMrD`

`:CALCulate:CDPower:WCODE:ORDER?`

Set the type of the Walsh code order to either of the following:

BREverse (Bit Reverse) – In the order to show the higher (consolidated) spreading code as a single bundle in the CDP display

HADMrD (Hadamard) – Regular order

Factory Preset: Hadamard (HADMrD)

Remarks: You must be in the cdma2000, or 1xEV-DO mode to use this command. Use INSTRument:SElect to set the mode.

## Test Current Results Against all Limits

**:CALCulate:CLIMits:FAIL?**

Queries the status of the current measurement limit testing. It returns a 0 if the measured results pass when compared with the current limits. It returns a 1 if the measured results fail any limit tests.

## Data Query

**:CALCulate:DATA [n] ?**

Returns the designated measurement data for the currently selected measurement and sub-opcode.

*n* = any valid sub-opcode for the current measurement. See the “MEASure Group of Commands” on page 318 for information on the data that can be returned for each measurement.

For sub-ops that return trace data use the **:CALCulate:DATA [n] :COMPRESS?** command below.

## Calculate/Compress Trace Data Query

**:CALCulate:DATA<n>:COMPRESS?**

**BLOCK | CFIT | MAXimum | MEAN | MINimum | RMS | SAMPLE | SDEVIation**  
[, <soffset> [, <length> [, <roffset> [, <rlimit> ] ] ] ]

Returns compressed data for the specified trace data. The data is returned in the same units as the original trace and only works with the currently selected measurement. The command is used with a sub-opcode <n> since measurements usually return several types of trace data. See the following table for the sub-ops for the trace data names that are available in each measurement. For sub-ops that return scalar data use the **:CALCulate:DATA [n] ?** command above.

This command is used to compress or decimate a long trace to extract and return only the desired data. A typical example would be to acquire N frames of GSM data and return the mean power of the first burst in each frame. The command can also be used to identify the best curve fit for the data.

**BLOCK** or block data - returns all the data points from the region of the trace data that you specify. For example, it could be used to return the data points of an input signal over several timeslots, excluding the portions of the trace data that you do not want.

**CFIT** or curve fit - applies curve fitting routines to the data. <soffset> and <length> are required to define the data that you want. <roffset> is an optional parameter for the desired order of the

curve equation. The query will return the following values: the x-offset (in seconds) and the curve coefficients ((order + 1) values).

MAX, MEAN, MIN, RMS, SAMP, and SDEV return one data value for each specified region (or <length>) of trace data, for as many regions as possible until you run out of trace data (using <roffset> to specify regions). Or they return the number regions you specify (using <rlimit>) ignoring any data beyond that.

**MAXimum** - returns the maximum data point for the specified region(s) of trace data. For I/Q trace data, the maximum magnitude of the I/Q pairs is returned.

**MEAN** - returns the arithmetic mean of the data point values for the specified region(s) of trace data. For I/Q trace data, the mean of the magnitudes of the I/Q pairs is returned. Note: If the original trace data is in dB, this function returns the arithmetic mean of those log values, not log of the mean power, which is a more useful value.

**MINimum** - returns the minimum data point for the specified region(s) of trace data. For I/Q trace data, the minimum magnitude of the I/Q pairs is returned.

**RMS** - returns the arithmetic rms of the data point values for the specified region(s) of trace data. For I/Q trace data, the rms of the magnitudes of the I/Q pairs is returned. Note: This function is very useful for I/Q trace data. However, if the original trace data is in dB, this function returns the rms of the log values which is not usually needed.

Once you have the rms value for a region of I/Q trace data, you may want to calculate the mean power. You must convert this rms I/Q value (peak volts) to power in dB.

$$10 \times \log[10 \times (\text{rms value})^2]$$

**SAMPle** - returns the first data value for the specified region(s) of trace data. For I/Q trace data, the first I/Q pair is returned.

**SDEViation** - returns the arithmetic standard deviation for the data point values for the specified region(s) of trace data. For I/Q trace data, the standard deviation of the magnitudes of the I/Q pairs is returned.

**Figure 5-1 Sample Trace Data - Constant Envelope**

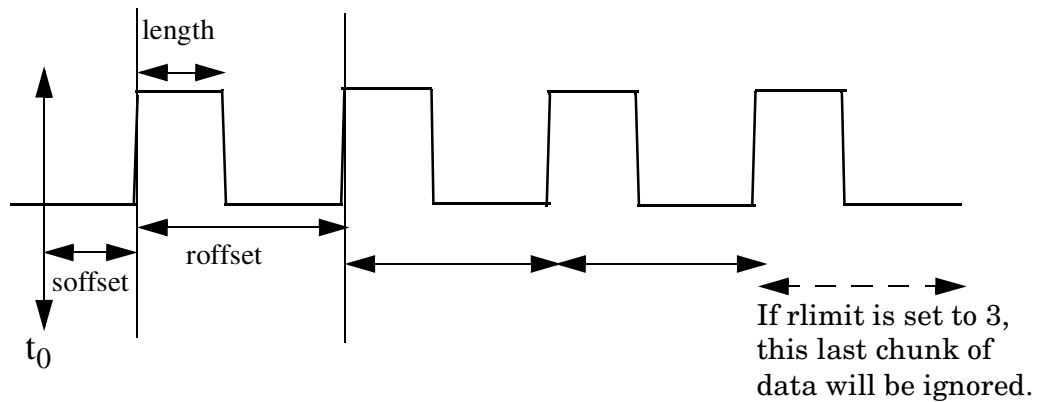

**Figure 5-2 Sample Trace Data - Not Constant Envelope**

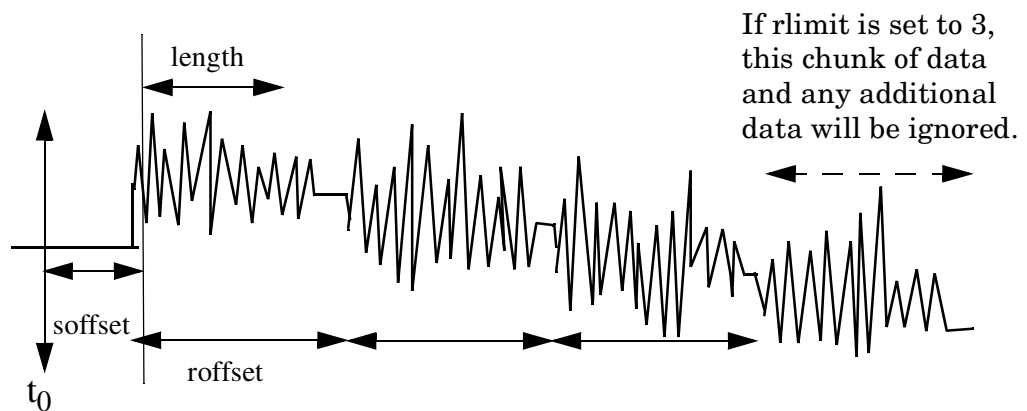

<soffset> - start offset is an optional real number (in seconds). It specifies the amount of data at the beginning of the trace that will be ignored before the decimation process starts. It is the time from the start of the trace to the point where you want to start using the data. The default value is zero.

<length> - is an optional real number (in seconds). It defines how much data will be compressed into one value. This parameter has a default value equal to the current trace length.

<roffset> - repeat offset is an optional real number (in seconds). It defines the beginning of the next field of trace elements to be compressed. This is relative to the beginning of the previous field. This parameter has a default value equal to the <length> variable.

<rlimit> - repeat limit is an optional integer. It specifies the number of data items that you want returned. It will ignore any additional items beyond that number. You can use the Start offset and the Repeat limit to pick out exactly what part of the data you want to use. The default value is all the data.

**Example:** To query the mean power of a set of GSM bursts:

1. Set the waveform measurement sweep time to acquire at least one burst.
2. Set the triggers such that acquisition happens at a known position relative to a burst.
3. Then query the mean burst levels using,  
**CALC:DATA2:COMP? MEAN, 24e-6, 526e-6** (These parameter values correspond to GSM signals, where 526e-6 is the length of the burst in the slot and you just want 1 burst.)

---

**NOTE** There is a more detailed example in the “Improving the Speed of Your Measurements” section in the PSA Series *User’s and Programmer’s Reference*. There is also a sample program in the Programming Fundamentals chapter of that book, and a copy of it is on the documentation CD-ROM.

---

**Remarks:** The optional parameters must be entered in the specified order. For example, if you want to specify <length>, you must also specify <soffset>.

This command uses the data in the format specified by FORMat:DATA, returning either binary or ASCII data.

**History:** Added in revision A.02.00

Measurement	Available Traces	Markers Available?
ACP - adjacent channel power (Basic, cdmaOne, cdma2000, W-CDMA, NADC, PDC modes)	no traces $(n=0)^a$ for I/Q points	no markers
CDPower - code domain power (cdmaOne mode)	POWer $(n=2)^a$ TIMing $(n=3)^a$ PHASe $(n=4)^a$ $(n=0)^a$ for I/Q points	yes

Measurement	Available Traces	Markers Available?
CDPower - code domain power (cdma2000, W-CDMA, 1xEV-DO modes)	CDPower ( $n=2$ ) <sup>a</sup> EVM ( $n=5$ ) <sup>a</sup> MERRor ( $n=6$ ) <sup>a</sup> PERRor ( $n=7$ ) <sup>a</sup> SPOWer ( $n=9$ ) <sup>a</sup> CPOWer ( $n=10$ ) <sup>a</sup> ( $n=0$ ) <sup>a</sup> for I/Q points	yes
CHPower - channel power (Basic, cdmaOne, cdma2000, W-CDMA, 1xEV-DO modes)	SPECTrum ( $n=2$ ) <sup>a</sup> ( $n=0$ ) <sup>a</sup> for I/Q points	no markers
CSPur - spurs close (cdmaOne mode)	SPECTrum ( $n=2$ ) <sup>a</sup> ULIMit ( $n=3$ ) <sup>a</sup> ( $n=0$ ) <sup>a</sup> for I/Q points	yes
EEVM - EDGE error vector magnitude (EDGE mode)	EVMerror ( $n=2$ ) <sup>a</sup> MERRor ( $n=3$ ) <sup>a</sup> PERRor ( $n=4$ ) <sup>a</sup> ( $n=0$ ) <sup>a</sup> for I/Q points	yes
EORFspectr - EDGE output RF spectrum (EDGE mode)	RFEMod ( $n=2$ ) <sup>a</sup> RFESwitching ( $n=3$ ) <sup>a</sup> SPEMod ( $n=4$ ) <sup>a</sup> LIMMod ( $n=5$ ) <sup>a</sup> ( $n=0$ ) <sup>a</sup> for I/Q points	yes, only for a single offset  yes, only for multiple offsets
EPVTime - EDGE power versus time (EDGE mode)	RFENvelope ( $n=2$ ) <sup>a</sup> UMASk ( $n=3$ ) <sup>a</sup> LMASk ( $n=4$ ) <sup>a</sup> ( $n=0$ ) <sup>a</sup> for I/Q points	yes
ETSPur - EDGE transmit band spurs (EDGE mode)	SPECTrum ( $n=2$ ) <sup>a</sup> ULIMit ( $n=3$ ) <sup>a</sup> ( $n=0$ ) <sup>a</sup> for I/Q points	yes

Measurement	Available Traces	Markers Available?
EVM - error vector magnitude (NADC, PDC modes)	EVM ( $n=2$ ) <sup>a</sup> MERRor ( $n=3$ ) <sup>a</sup> PERRor ( $n=4$ ) <sup>a</sup> ( $n=0$ ) <sup>a</sup> for I/Q points	yes
EVMQpsk - QPSK error vector magnitude (cdma2000, W-CDMA, 1xEV-DO modes)	EVM ( $n=2$ ) <sup>a</sup> MERRor ( $n=3$ ) <sup>a</sup> PERRor ( $n=4$ ) <sup>a</sup> ( $n=0$ ) <sup>a</sup> for I/Q points	yes
IM - intermodulation (cdma2000, W-CDMA, 1xEV-DO modes)	SPECtrum ( $n=2$ ) <sup>a</sup> ( $n=0$ ) <sup>a</sup> for I/Q points	yes
MCPower - multi-carrier power (W-CDMA mode)	no traces ( $n=0$ ) <sup>a</sup> for I/Q points	no markers
OBW - occupied bandwidth (cdmaOne, cdma2000, PDC, W-CDMA, 1xEV-DO modes)	no traces ( $n=0$ ) <sup>a</sup> for I/Q points	no markers
ORFSpectrum - output RF spectrum (GSM, EDGE mode)	RFEMod ( $n=2$ ) <sup>a</sup> RFESwitching ( $n=3$ ) <sup>a</sup> SPEMod ( $n=4$ ) <sup>a</sup> LIMMod ( $n=5$ ) <sup>a</sup> ( $n=0$ ) <sup>a</sup> for I/Q points	yes, only for a single offset  yes, only for multiple offsets
PFERror - phase and frequency error (GSM, EDGE mode)	PERRor ( $n=2$ ) <sup>a</sup> PFERror ( $n=3$ ) <sup>a</sup> RFENvelope ( $n=4$ ) <sup>a</sup> ( $n=0$ ) <sup>a</sup> for I/Q points	yes
PStatistic - power statistics CCDF (Basic, cdma2000, W-CDMA, 1xEV-DO modes)	MEASured ( $n=2$ ) <sup>a</sup> GAUSSian ( $n=3$ ) <sup>a</sup> REFerence ( $n=4$ ) <sup>a</sup> ( $n=0$ ) <sup>a</sup> for I/Q points	yes



Measurement	Available Traces	Markers Available?
PVTime - power versus time (GSM, EDGE, 1xEV-DO modes)	RFENvelope ( $n=2$ ) <sup>a</sup> UMASk ( $n=3$ ) <sup>a</sup> LMASk ( $n=4$ ) <sup>a</sup> ( $n=0$ ) <sup>a</sup> for I/Q points	yes
RHO - modulation quality (cdmaOne, cdma2000, W-CDMA, 1xEV-DO mode)	( $n=0$ ) <sup>a</sup> for I/Q points EVM ( $n=2$ ) <sup>a</sup> MERRor ( $n=3$ ) <sup>a</sup> PERRor ( $n=4$ ) <sup>a</sup> ( $n=0$ ) <sup>a</sup> for I/Q points	yes
SEMask - spectrum emissions mask (cdma2000, W-CDMA, 1xEV-DO mode)	SPECTrum ( $n=2$ ) <sup>a</sup> ( $n=0$ ) <sup>a</sup> for I/Q points	yes
TSPur - transmit band spurs (GSM, EDGE mode)	SPECTrum ( $n=2$ ) <sup>a</sup> ULIMit ( $n=3$ ) <sup>a</sup> ( $n=0$ ) <sup>a</sup> for I/Q points	yes
TXPower - transmit power (GSM, EDGE mode)	RFENvelope ( $n=2$ ) <sup>a</sup> IQ ( $n=8$ ) <sup>a</sup> ( $n=0$ ) <sup>a</sup> for I/Q points	yes
SPECTrum - (frequency domain) (all modes)	IQ ( $n=3$ ) <sup>a</sup> SPECTrum ( $n=4$ ) <sup>a</sup> ASPECTrum ( $n=7$ ) <sup>a</sup> ( $n=0$ ) <sup>a</sup> for I/Q points	yes
WAVEform - (time domain) (all modes)	RFENvelope ( $n=2$ ) <sup>a</sup> (also for Signal Envelope trace) IQ ( $n=5$ ) <sup>a</sup> ( $n=0$ ) <sup>a</sup> for I/Q points	yes

a. The  $n$  number indicates the sub-opcode that corresponds to this trace. Detailed descriptions of the trace data can be found in the MEASure subsystem documentation by looking up the sub-opcode for the appropriate measurement.

## Calculate Peaks of Trace Data

```
:CALCulate:DATA<n>:PEAKs?  
<threshold>,<excursion>[,AMPLitude|FREQuency|TIME]
```

Returns a list of peaks for the designated trace data *n* for the currently selected measurement. The peaks must meet the requirements of the peak threshold and excursion values.

The command can only be used with specific *<n>* (sub-opcode) values, for measurement results that are trace, or scalar, data. See the table above for the appropriate sub-opcodes. Both real and complex traces can be searched, but complex traces are converted to magnitude in dBm. Sub-opcode *n=0*, is the raw trace data which cannot be searched for peaks. Sub-opcode *n=1*, is the scaler data which also cannot be searched for peaks.

Threshold - is the level below which trace data peaks are ignored

Excursion - To be defined as a peak, the signal must rise above the threshold by a minimum amplitude change (excursion). Excursion is measured from the lowest point above the threshold (of the rising edge of the peak), to the highest signal point that begins the falling edge. If a signal valley is higher than the threshold, then the excursion is referenced to that valley, and a peak is only defined if the signal following that valley exceeds the excursion.

Amplitude - lists the peaks in order of descending amplitude, so the highest peak is listed first. This is the default peak order listing if the optional parameter is not specified.

Frequency - lists the peaks in order of occurrence, left to right across the x-axis

Time - lists the peaks in order of occurrence, left to right across the x-axis

Example:       Select the spectrum measurement.

Use `CALC:DATA4:PEAK? -40,10,FREQ` to identify the peaks above -40 dBm, with excursions of at least 10 dB, in order of increasing frequency.

Query Results: Returns a list of floating-point numbers. The first value in the list is the number of peak points that follow. A peak point consists of two values: a peak amplitude followed by the its corresponding frequency (or time).

If no peaks are found the peak list will consist of only the number of peaks, (0).

The peak list is limited to 100 peaks. Peaks in excess of

100 are ignored.

Remarks: This command uses the data setting specified by the FORMat:DATA command and can return real 32-bit, real 64-bit, or ASCII data. The default data format is ASCII.

## CALCulate:MARKers Subsystem

Markers can be put on your displayed measurement data to supply information about specific points on the data. Some of the things that markers can be used to measure include: precise frequency at a point, minimum or maximum amplitude, and the difference in amplitude or frequency between two points.

When using the marker commands you must specify the measurement in the SCPI command. We recommend that you use the marker commands only on the current measurement. Many marker commands will return invalid results, when used on a measurement that is not current. (This is true for commands that do more than simply setting or querying an instrument parameter.) No error is reported for these invalid results.

You must make sure that the measurement is completed before trying to query the marker value. Using the MEASure or READ command, before the marker command, forces the measurement to complete before allowing the next command to be executed.

Each measurement has its own instrument state for marker parameters. Therefore, if you exit the measurement, the marker settings in each measurement are saved and are then recalled when you change back to that measurement.

### Basic Mode - <measurement> key words

- SPECTrum - markers available
- WAVeform - markers available

### 1xEV-DO Mode - <measurement> key words

- CDPower - markers available
- CHPower - no markers
- EVMQpsk - markers available
- IM - markers available
- OBW - no markers
- PSTatistic - markers available
- PVTime - markers available
- RHO - markers available
- SEMask - markers available
- SPECTrum - markers available

- WAVeform - markers available

**cdmaOne Mode - <measurement> key words**

- ACPr - no markers
- CHPower - no markers
- CDPower - markers available
- CSPur - markers available
- RHO - markers available
- SPECTrum - markers available
- WAVeform - markers available

**cdma2000 Mode - <measurement> key words**

- ACP - no markers
- CDPower - markers available
- CHPower - no markers
- EVMQpsk - markers available
- IM - markers available
- OBW - no markers
- PStatistic - markers available
- RHO - markers available
- SEMask - markers available
- SPECTrum - markers available
- WAVeform - markers available

**GSM (with EDGE) Mode - <measurement> key words**

- EEVM - markers available
- EORFspectr - markers available
- EPVTime - no markers
- ETSPur - markers available
- ORFSpectrum - markers available
- PFERror - markers available
- PVTime - no markers
- SPECTrum - markers available
- TSPur - markers available
- TXPower - no markers
- WAVeform - markers available

**NADC Mode - <measurement> key words**

- ACP - no markers
- EVM - markers available
- SPECTrum - markers available
- WAVeform - markers available

**PDC Mode - <measurement> key words**

- ACP - no markers
- EVM - markers available

- OBW - no markers
- SPECTrum - markers available
- WAVeform - markers available

### W-CDMA Mode - <measurement> key words

- ACP - no markers
- CDPower - markers available
- CHPower - no markers
- EVMQpsk - markers available
- IM - markers available
- MCPower - no markers
- OBW - no markers
- PSTatistic - markers available
- RHO - markers available
- SEMask - markers available
- SPECTrum - markers available
- WAVeform - markers available

### Example:

Suppose you are using the Spectrum measurement in your measurement personality. To position marker 2 at the maximum peak value of the trace that marker 2 is currently on, the command is:

```
:CALCulate:SPECTrum:MARKer2:MAXimum
```

You must make sure that the measurement is completed before trying to query the marker value. Use the MEASURE or READ command before using the marker command. This forces the measurement to complete before allowing the next command to be executed.

### Markers All Off on All Traces

```
:CALCulate:<measurement>:MARKer:AOff
```

Turns off all markers on all the traces in the specified measurement.

Example:        **CALC:SPEC:MARK:AOff**

Remarks:        The keyword for the current measurement must be specified in the command. (Some examples include: SPECTrum, WAVeform)

Front Panel

Access:        **Marker, More, Marker All Off**

### Marker Function Result

```
:CALCulate:<measurement>:MARKer [1] | 2 | 3 | 4 :FUNCTION:RESult?
```

Queries the result of the currently active marker function. The measurement must be completed before querying the marker. A particular measurement may not have all the types of markers available.

The marker must have already been assigned to a trace. Use `:CALCulate:<measurement>:MARKer [1] | 2 | 3 | 4:TRACe` to assign a marker to a particular trace.

Example: `CALC:SPEC:MARK:FUNC:RES?`

Remarks: The keyword for the current measurement must be specified in the command. (Some examples include: SPECTrum, WAVeform)

Front Panel

Access: **Marker, Marker Function**

### Marker Peak (Maximum) Search

`:CALCulate:<measurement>:MARKer [1] | 2 | 3 | 4:MAXimum`

Places the selected marker on the highest point on the trace that is assigned to that particular marker number.

The marker must have already been assigned to a trace. Use `:CALCulate:<measurement>:MARKer [1] | 2 | 3 | 4:TRACe` to assign a marker to a particular trace.

Example: `CALC:SPEC:MARK1:MAX`

Remarks: The keyword for the current measurement must be specified in the command. (Some examples include: SPECTrum, WAVeform)

Front Panel

Access: **Search**

### Marker Peak (Minimum) Search

`:CALCulate:<measurement>:MARKer [1] | 2 | 3 | 4:MINimum`

Places the selected marker on the lowest point on the trace that is assigned to that particular marker number.

The marker must have already been assigned to a trace. Use `:CALCulate:<measurement>:MARKer [1] | 2 | 3 | 4:TRACe` to assign a marker to a particular trace.

Example: `CALC:SPEC:MARK2 MIN`

Remarks: The keyword for the current measurement must be specified in the command. (Some examples include:

SPECTrum, WAVeform)

### Marker Mode

*PSA Series (Basic, cdmaOne, cdma2000, W-CDMA, GSM/EDGE, NADC, PDC modes):*

```
:CALCulate:<measurement>:MARKer [1] | 2 | 3 | 4:MODE  
POSITION|DELTA
```

*ESA/PSA Series (Phase Noise mode only):*

```
:CALCulate:<measurement>:MARKer [1] | 2 | 3 | 4:MODE  
POSITION|DELTA|RMSDegree|RMSRadian|RFM|RMSJitter|OFF
```

```
:CALCulate:<measurement>:MARKer [1] | 2 | 3 | 4:MODE?
```

VSA/PSA: Selects the type of marker to be a normal position-type marker or a delta marker. A specific measurement may not have both types of markers. For example, several measurements only have position markers

ESA/PSA Phase Noise Mode: Selects the type of marker to be a normal position-type marker, a delta marker or an RMS measurement marker.

The marker must have already been assigned to a trace. Use

```
:CALCulate:<measurement>:MARKer [1] | 2 | 3 | 4:TRACe
```

to assign a marker to a particular trace.

Example:       **CALC:SPEC:MARK:MODE DELTA**

Remarks:       For the delta mode only markers 1 and 2 are valid.

The keyword for the current measurement must be specified in the command. (Some examples include: SPECTrum, WAVeform)

Front Panel

Access:       **Marker, Marker [Delta]**

### Marker On/Off

```
:CALCulate:<measurement>:MARKer [1] | 2 | 3 | 4[:STATe] OFF|ON|0|1
```

```
:CALCulate:<measurement>:MARKer [1] | 2 | 3 | 4[:STATe] ?
```

Turns the selected marker on or off.

The marker must have already been assigned to a trace. Use

```
:CALCulate:<measurement>:MARKer [1] | 2 | 3 | 4:TRACe
```

to assign a marker to a particular trace.

Example:       **CALC:SPEC:MARK2: on**

Remarks: The keyword for the current measurement must be specified in the command. (Some examples include: SPECTrum, AREFERENCE, WAVeform)

The WAVeform measurement only has two markers available.

Front Panel

Access: **Marker, Select** then **Marker Normal** or **Marker On Off**

### Marker to Trace

**:CALCulate:<measurement>:MARKer [1] | 2 | 3 | 4:TRACe <trace\_name>**

**:CALCulate:<measurement>:MARKer [1] | 2 | 3 | 4:TRACe?**

Assigns the specified marker to the designated trace. Not all types of measurement data can have markers assigned to them.

Example: With the WAVeform measurement selected, a valid command is **CALC:SPEC:MARK2:TRACE rfenvelope**.

Range: The names of valid traces are dependent upon the selected measurement. See the following table for the available trace names. The trace name assignment is independent of the marker number.

Remarks: The keyword for the current measurement must be specified in the command. (Some examples include: SPECTrum, WAVeform)

Front Panel

Access: **Marker, Marker Trace**

Measurement	Available Traces	Markers Available?
ACP - adjacent channel power (Basic, cdmaOne, cdma2000, W-CDMA, NADC, PDC modes)	no traces $(n=0)^a$ for I/Q points	no markers
CDPower - code domain power (cdmaOne mode)	POWer $(n=2)^a$ TIMing $(n=3)^a$ PHASe $(n=4)^a$ $(n=0)^a$ for I/Q points	yes



Measurement	Available Traces	Markers Available?
CDPower - code domain power (cdma2000, W-CDMA, 1xEV-DO modes)	CDPower ( $n=2$ ) <sup>a</sup> EVM ( $n=5$ ) <sup>a</sup> MERRor ( $n=6$ ) <sup>a</sup> PERRor ( $n=7$ ) <sup>a</sup> SPOWer ( $n=9$ ) <sup>a</sup> CPOWer ( $n=10$ ) <sup>a</sup> ( $n=0$ ) <sup>a</sup> for I/Q points	yes
CHPower - channel power (Basic, cdmaOne, cdma2000, W-CDMA, 1xEV-DO modes)	SPECTrum ( $n=2$ ) <sup>a</sup> ( $n=0$ ) <sup>a</sup> for I/Q points	no markers
CSPur - spurs close (cdmaOne mode)	SPECTrum ( $n=2$ ) <sup>a</sup> ULIMit ( $n=3$ ) <sup>a</sup> ( $n=0$ ) <sup>a</sup> for I/Q points	yes
EEVM - EDGE error vector magnitude (EDGE mode)	EVMerror ( $n=2$ ) <sup>a</sup> MERRor ( $n=3$ ) <sup>a</sup> PERRor ( $n=4$ ) <sup>a</sup> ( $n=0$ ) <sup>a</sup> for I/Q points	yes
EORFspectr - EDGE output RF spectrum (EDGE mode)	RFEMod ( $n=2$ ) <sup>a</sup> RFESwitching ( $n=3$ ) <sup>a</sup> SPEMod ( $n=4$ ) <sup>a</sup> LIMMod ( $n=5$ ) <sup>a</sup> ( $n=0$ ) <sup>a</sup> for I/Q points	yes, only for a single offset  yes, only for multiple offsets
EPVTime - EDGE power versus time (EDGE mode)	RFENvelope ( $n=2$ ) <sup>a</sup> UMASk ( $n=3$ ) <sup>a</sup> LMASk ( $n=4$ ) <sup>a</sup> ( $n=0$ ) <sup>a</sup> for I/Q points	yes
ETSPur - EDGE transmit band spurs (EDGE mode)	SPECTrum ( $n=2$ ) <sup>a</sup> ULIMit ( $n=3$ ) <sup>a</sup> ( $n=0$ ) <sup>a</sup> for I/Q points	yes

Measurement	Available Traces	Markers Available?
EVM - error vector magnitude (NADC, PDC modes)	EVM ( $n=2$ ) <sup>a</sup> MERRor ( $n=3$ ) <sup>a</sup> PERRor ( $n=4$ ) <sup>a</sup> ( $n=0$ ) <sup>a</sup> for I/Q points	yes
EVMQpsk - QPSK error vector magnitude (cdma2000, W-CDMA, 1xEV-DO modes)	EVM ( $n=2$ ) <sup>a</sup> MERRor ( $n=3$ ) <sup>a</sup> PERRor ( $n=4$ ) <sup>a</sup> ( $n=0$ ) <sup>a</sup> for I/Q points	yes
IM - intermodulation (cdma2000, W-CDMA, 1xEV-DO modes)	SPECtrum ( $n=2$ ) <sup>a</sup> ( $n=0$ ) <sup>a</sup> for I/Q points	yes
MCPower - multi-carrier power (W-CDMA mode)	no traces ( $n=0$ ) <sup>a</sup> for I/Q points	no markers
OBW - occupied bandwidth (cdmaOne, cdma2000, PDC, W-CDMA, 1xEV-DO modes)	no traces ( $n=0$ ) <sup>a</sup> for I/Q points	no markers
ORFSpectrum - output RF spectrum (GSM, EDGE mode)	RFEMod ( $n=2$ ) <sup>a</sup> RFESwitching ( $n=3$ ) <sup>a</sup> SPEMod ( $n=4$ ) <sup>a</sup> LIMMod ( $n=5$ ) <sup>a</sup> ( $n=0$ ) <sup>a</sup> for I/Q points	yes, only for a single offset  yes, only for multiple offsets
PFERror - phase and frequency error (GSM, EDGE mode)	PERRor ( $n=2$ ) <sup>a</sup> PFERror ( $n=3$ ) <sup>a</sup> RFENvelope ( $n=4$ ) <sup>a</sup> ( $n=0$ ) <sup>a</sup> for I/Q points	yes
PStatistic - power statistics CCDF (Basic, cdma2000, W-CDMA, 1xEV-DO modes)	MEASured ( $n=2$ ) <sup>a</sup> GAUSSian ( $n=3$ ) <sup>a</sup> REFerence ( $n=4$ ) <sup>a</sup> ( $n=0$ ) <sup>a</sup> for I/Q points	yes

Measurement	Available Traces	Markers Available?
PVTime - power versus time (GSM, EDGE, 1xEV-DO modes)	RFENvelope ( $n=2$ ) <sup>a</sup> UMASk ( $n=3$ ) <sup>a</sup> LMASk ( $n=4$ ) <sup>a</sup> ( $n=0$ ) <sup>a</sup> for I/Q points	yes
RHO - modulation quality (cdmaOne, cdma2000, W-CDMA, 1xEV-DO mode)	( $n=0$ ) <sup>a</sup> for I/Q points EVM ( $n=2$ ) <sup>a</sup> MERRor ( $n=3$ ) <sup>a</sup> PERRor ( $n=4$ ) <sup>a</sup> ( $n=0$ ) <sup>a</sup> for I/Q points	yes
SEMask - spectrum emissions mask (cdma2000, W-CDMA, 1xEV-DO mode)	SPECTrum ( $n=2$ ) <sup>a</sup> ( $n=0$ ) <sup>a</sup> for I/Q points	yes
TSPur - transmit band spurs (GSM, EDGE mode)	SPECTrum ( $n=2$ ) <sup>a</sup> ULIMit ( $n=3$ ) <sup>a</sup> ( $n=0$ ) <sup>a</sup> for I/Q points	yes
TXPower - transmit power (GSM, EDGE mode)	RFENvelope ( $n=2$ ) <sup>a</sup> IQ ( $n=8$ ) <sup>a</sup> ( $n=0$ ) <sup>a</sup> for I/Q points	yes
SPECTrum - (frequency domain) (all modes)	IQ ( $n=3$ ) <sup>a</sup> SPECTrum ( $n=4$ ) <sup>a</sup> ASPECTrum ( $n=7$ ) <sup>a</sup> ( $n=0$ ) <sup>a</sup> for I/Q points	yes
WAVEform - (time domain) (all modes)	RFENvelope ( $n=2$ ) <sup>a</sup> (also for Signal Envelope trace) IQ ( $n=5$ ) <sup>a</sup> ( $n=0$ ) <sup>a</sup> for I/Q points	yes

a. The  $n$  number indicates the sub-opcode that corresponds to this trace. Detailed descriptions of the trace data can be found in the MEASure subsystem documentation by looking up the sub-opcode for the appropriate measurement.

## Marker X Value

**:CALCulate:<measurement>:MARKer [1] | 2 | 3 | 4:X <param>**

**:CALCulate:<measurement>:MARKer [1] | 2 | 3 | 4:X?**

Position the designated marker on its assigned trace at the specified X value. The parameter value is in X-axis units (which is often frequency or time).

The marker must have already been assigned to a trace. Use **:CALCulate:<measurement>:MARKer [1] | 2 | 3 | 4:TRACe** to assign a marker to a particular trace.

The query returns the current X value of the designated marker. The measurement must be completed before querying the marker.

Example:       **CALC:SPEC:MARK2:X 1.2e6 Hz**

Default Unit:   Matches the units of the trace on which the marker is positioned

Remarks:       The keyword for the current measurement must be specified in the command. (Some examples include: SPECTrum, WAVeform)

Front Panel

Access:         **Marker, <active marker>, RPG**

## Marker X Position

**:CALCulate:<measurement>:MARKer [1] | 2 | 3 | 4:X:POSition <integer>**

**:CALCulate:<measurement>:MARKer [1] | 2 | 3 | 4:X:POSition?**

Position the designated marker on its assigned trace at the specified X position. A trace is composed of a variable number of measurement points. This number changes depending on the current measurement conditions. The current number of points must be identified before using this command to place the marker at a specific location.

The marker must have already been assigned to a trace. Use **:CALCulate:<measurement>:MARKer [1] | 2 | 3 | 4:TRACe** to assign a marker to a particular trace.

The query returns the current X position for the designated marker. The measurement must be completed before querying the marker.

Example:       **CALC:SPEC:MARK:X:POS 500**

Range:         0 to a maximum of (3 to 920,000)

Remarks: The keyword for the current measurement must be specified in the command. (Some examples include: SPECTrum, WAVeform)

Front Panel

Access: **Marker, <active marker>, RPG**

### Marker Readout Y Value

**:CALCulate:<measurement>:MARKer [1] | 2 | 3 | 4:Y?**

Readout the current Y value for the designated marker on its assigned trace. The value is in the Y-axis units for the trace (which is often dBm).

The marker must have already been assigned to a trace. Use **:CALCulate:<measurement>:MARKer [1] | 2 | 3 | 4:TRACe** to assign a marker to a particular trace.

The measurement must be completed before querying the marker.

Example: **CALC:SPEC:MARK1:Y?**

Default Unit: Matches the units of the trace on which the marker is positioned

Remarks: The keyword for the current measurement must be specified in the command. (Some examples include: SPECTrum, WAVeform)

## Occupied Bandwidth - Limits

### Occupied Bandwidth—Frequency Band Limit

*PDC, cdma2000, W-CDMA, 1xEV-DO mode*

**:CALCulate:OBW:LIMit:FBLimit <freq>**

**:CALCulate:OBW:LIMit:FBLimit?**

Set the frequency bandwidth limit in Hz.

Factory Preset: 32 kHz for PDC

1.48 MHz for cdma2000, 1xEV-DO

5 MHz for W-CDMA

Range: 10 kHz to 60 kHz for PDC

10 kHz to 10 MHz for cdma2000, W-CDMA, 1xEV-DO

Default Unit: Hz

Remarks: You must be in the PDC, cdma2000, W-CDMA, or

1xEV-DO mode to use this command. Use  
INSTRument:SElect to set the mode.

### Occupied Bandwidth—Limit Test

*PDC, cdma2000, W-CDMA, 1xEV-DO mode*

```
:CALCulate:OBW:LIMit[:TEST] OFF|ON|0|1
```

```
:CALCulate:OBW:LIMit[:TEST]?
```

Turn the limit test function on or off.

Factory Preset: ON

Remarks: You must be in the PDC, cdma2000, W-CDMA, or  
1xEV-DO mode to use this command. Use  
INSTRument:SElect to set the mode.

### Power Statistic CCDF—Store Reference

```
:CALCulate:PStatistic:StORe:REFErence ON|1
```

Store the currently measured trace as the user-defined reference trace.  
No query command is available.

Remarks: You must be in the cdma2000, W-CDMA, or 1xEV-DO  
mode to use this command. Use INSTRument:SElect to  
set the mode.

### Modulation Accuracy - Limits

#### Modulation Accuracy (Rho)—Active Set Threshold

```
:CALCulate:RHO:ASET:THReshold <numeric>
```

```
:CALCulate:RHO:ASET:THReshold?
```

Set the threshold level for the active channel identification function.

Factory Preset: 0.0 dBm

Range: -100.0 to 0.0 dB

Remarks: You must be in the 1xEV-DO mode to use this  
command. Use INSTRument:SElect to set the mode.

### Modulation Accuracy (Rho)—Active Set Threshold Mode

`:CALCulate:RHO:ASET:THReshold:AUTO OFF | ON | 0 | 1`

`:CALCulate:RHO:ASET:THReshold:AUTO?`

Turn the automatic mode On or Off, for the active channel identification function.

OFF – The active channel identification for each code channel is determined by a value set by `CALCulate:RHO:ASET:THReshold`.

ON – The active channels are determined automatically by the internal algorithm.

Factory Preset: ON

Remarks: You must be in W-CDMA, cdma2000, or 1xEV-DO mode to use this command. Use `INSTRument:SElect` to set the mode.

### Modulation Accuracy (Rho)—Code Domain Error Limit

`:CALCulate:RHO:LIMit:CDError <float>`

`:CALCulate:RHO:LIMit:CDError?`

Set the Peak Code Domain Error limit in dB.

Factory Preset: 0.0 dB for cdma2000

–32.0 dB for W-CDMA

Range: –100.0 to 0.0 dB

Remarks: You must be in the cdma2000 or W-CDMA mode to use this command. Use `INSTRument:SElect` to set the mode.

### Modulation Accuracy (Rho)—Peak EVM Limit

`:CALCulate:RHO:LIMit:PEAK <float>`

`:CALCulate:RHO:LIMit:PEAK?`

Specify a limit value in percent for the peak EVM test.

Factory Preset: 100.0%

Range: 0.0 to 100.0%

Remarks: You must be in the cdma2000, W-CDMA, or 1xEV-DO mode to use this command. Use `INSTRument:SElect` to set the mode.

### Modulation Accuracy (Rho)—Phase Error Limit

`:CALCulate:RHO:LIMit:PHASe <float>`

`:CALCulate:RHO:LIMit:PHASe?`

Specify a limit value in radian for the phase error test.

Factory Preset: 0.05 rad

Range: 0.00 to 3.00 rad

Remarks: You must be in the cdma2000 or 1xEV-DO mode to use this command. Use INSTRument:SElect to set the mode.

### Modulation Accuracy (Rho)—Rho Limit

`:CALCulate:RHO:LIMit:RHO <float>`

`:CALCulate:RHO:LIMit:RHO?`

Specify a limit value for the Rho test.

Factory Preset: 0.912

Range: 0 to 1.0

Remarks: You must be in the cdma2000, W-CDMA, or 1xEV-DO mode to use this command. Use INSTRument:SElect to set the mode.

### Modulation Accuracy (Rho)—RMS EVM Limit

`:CALCulate:RHO:LIMit:RMS <float>`

`:CALCulate:RHO:LIMit:RMS?`

Specify a limit value in percent for the rms EVM test.

Factory Preset: 17.5%

Range: 0.0 to 50.0%

Remarks: You must be in the cdma2000, W-CDMA, or 1xEV-DO mode to use this command. Use INSTRument:SElect to set the mode.

### Modulation Accuracy (Rho)—Time Offset Limit

`:CALCulate:RHO:LIMit:TIMing <float>`

`:CALCulate:RHO:LIMit:TIMing?`



Specify a limit value in second for the time offset test.

Factory Preset: 0.00000005 s (50 ns)

Range: 0 to 0.0000005 s (0 to 500 ns)

Remarks: You must be in the cdma2000 or 1xEV-DO mode to use this command. Use INSTRument:SElect to set the mode.

### **Modulation Accuracy (Rho)— Pseudo-Random Noise Offset**

**:CALCulate:RHO:PNOffset <time>**

**:CALCulate:RHO:PNOffset?**

Sets value for the psuedo-random noise offset. Different psuedo-random noise offsets are used for different base stations. By setting the pseudo-random noise offset to the value that your specific base station is set to, you get the correct time offset value displayed and returned back to you when you query READ:RHO? The instrument, by default, assumes an offset of 0. So if you do not use this command you will have to manually calculate the time offset when the value is other than 0.

Factory Preset: 0 chips offset

Range: 0 to 511 (× 64 chips) 1 = 64 chip offset, 2 = 128 chips

Remarks: You must be in the cdma2000 mode to use this command. Use INSTRument:SElect to set the mode.

---

## CONFigure Subsystem

The CONFigure commands are used with several other commands to control the measurement process. The full set of commands are described in the section “MEASure Group of Commands” on page 318.

Selecting measurements with the CONFigure/FETCh/MEASure/READ commands sets the instrument state to the defaults for that measurement and to make a single measurement. Other commands are available for each measurement to allow you to change: settings, view, limits, etc. Refer to:

SENSE:<measurement>, SENSE:CHANnel, SENSE:CORRection,  
SENSE:DEFaults, SENSE:DEViation, SENSE:FREQuency,  
SENSE:PACKet, SENSE:POWer, SENSE:RADio, SENSE:SYNC  
CALCulate:<measurement>, CALCulate:CLIMits  
DISPlay:<measurement>  
TRIGger

The INITiate[:IMMediate] or INITiate:REStart commands will initiate the taking of measurement data without resetting any of the measurement settings that you have changed from their defaults.

### Configure the Selected Measurement

**:CONFigure:<measurement>**

A CONFigure command must specify the desired measurement. It will set the instrument settings for that measurements standard defaults, but should not initiate the taking of data. The available measurements are described in the MEASure subsystem.

---

**NOTE**

If CONFigure initiates the the taking of data, the data should be ignored. Other SCPI commands can be processed immediately after sending CONFigure. You do not need to wait for the CONF command to complete this 'false' data acquisition.

---

### Configure Query

**:CONFigure?**

The CONFigure query returns the name of the current measurement.

## DISPlay Subsystem

The DISPlay controls the selection and presentation of textual, graphical, and TRACe information. Within a DISPlay, information may be separated into individual WINDows.

### Adjacent Channel Power - View Selection

```
:DISPlay:ACP:VIEW BGRaph|SPEctrum
```

```
:DISPlay:ACP:VIEW?
```

Select the adjacent channel power measurement display of bar graph or spectrum.

You may want to disable the spectrum trace data part of the measurement so you can increase the speed of the rest of the measurement display. Use SENSE:ACP:SPECTrum:ENABLE to turn on or off the spectrum trace. (Basic and cdmaOne modes only)

Factory Preset: Bar Graph (BGRaph)

Remarks: You must be in the cdmaOne, cdma2000, W-CDMA, NADC or PDC mode to use this command. Use INSTRument:SElect to set the mode.

Front Panel

Access: **ACP, View/Trace**

### Code Domain - Base Code Length

```
:DISPlay:CDPower:BCLength 64|128
```

```
:DISPlay:CDPower:BCLength?
```

Set the base code length.

Factory Preset: 64

Remarks: You must be in the cdma2000 mode to use this command. Use INSTRument:SElect to set the mode.

### Select Display Format

```
:DISPlay:FORMat:TILE
```

Selects the viewing format that displays multiple windows of the current measurement data simultaneously. Use DISP:FORM:ZOOM to

return the display to a single window.

Remarks: You must be in the Basic, cdmaOne,cdma2000, 1xEV-DO, W-CDMA, GSM (w/EDGE), NADC, or PDC mode to use this command. Use INSTRUMENT:SElect to set the mode

Front Panel

Access: **Zoom** (toggles between Tile and Zoom)

## Select Display Format

**:DISPlay:FORMat:ZOOM**

Selects the viewing format that displays only one window of the current measurement data (the current active window). Use DISP:FORM:TILE to return the display to multiple windows.

Remarks: You must be in the Basic, cdmaOne,cdma2000, 1xEV-DO, W-CDMA, GSM (w/EDGE), NADC, or PDC mode to use this command. Use INSTRUMENT:SElect to set the mode

Front Panel

Access: **Zoom** (toggles between Tile and Zoom)

## Modulation Accuracy (Rho) - View Selection

*1xEV-DO*

**:DISPlay:RHO:VIEW ERROR | POLar | QUAD | TABLE | TPHase**

*W-CDMA, cdma2000*

**:DISPlay:RHO:VIEW POLar | ERROR**

**:DISPlay:RHO:VIEW?**

Select one of the modulation accuracy (rho) measurement result views as follows:

**ERROR** (IQ Error: Quad View) - provides a combination view of the EVM vs. symbol, phase error vs. symbol, magnitude error vs. symbol graphs, and the summary data for each channel type specified.

**POLar** (IQ Measured Polar Graph) - provides a combination view of the I/Q measured polar constellation graph and the summary data for each channel type specified including Overall 1 and Overall 2.

**QUAD** (IQ Measured: Quad-view) - provides a combination view of an I/Q power vs. chip, I/Q vector absolute power vs. chip, I/Q polar graphs, and the summary data for each channel type specified

including Overall 1 and Overall 2.

**TABLE (Result Metrics)** - provides a measurement result on Rho, EVM, and other metrics of each channel type specified including Overall 1 and Overall 2 in tabular form.

**TPHase (Power Timing and Phase)** - provides a measurement result on power levels, timing, phase, and code domain errors in tabular form for each active code.

Factory Preset: POLar

Remarks: You must be in the 1xEV-DO, W-CDMA, or cdma2000 mode to use this command. Use INSTRUMENT:SElect to set the mode.

Front Panel

Access: **Mod Accuracy, View/Trace**

## Spectrum - Y-Axis Scale/Div

```
:DISPlay:SPECTrum[n]:WINDow[m]:TRACe:Y[:SCALE]:PDIVision
<power>
```

```
:DISPlay:SPECTrum[n]:WINDow[m]:TRACe:Y[:SCALE]:PDIVision?
```

Sets the amplitude reference level for the y-axis.

n – selects the view, the default is Spectrum.

m – selects the window within the view. The default is 1.

— n=1, m=1 Spectrum

— n=1, m=2 I/Q Waveform

— n=1, m=2 I and Q Waveform (Basic, W-CDMA, cdma2000)

— n=3, m=1 I/Q Polar (Basic, W-CDMA, cdma2000)

— n=4, m=1 Linear Spectrum (Basic, W-CDMA, cdma2000)

Factory Preset: 10 dB per division, for Spectrum

100 mV per division, for I/Q Waveform

Range: 0.1 dB to 20 dB per division, for Spectrum

1 nV to 20 V per division, for I/Q Waveform

Default Unit: 10 dB per division, for Spectrum

Remarks: May affect input attenuator setting.

You must be in Basic, cdmaOne, cdma2000, 1xEV-DO, W-CDMA GSM w/EDGE, NADC, or PDC mode. Set the mode with INSTRUMENT:SElect.

Front Panel

Access: When in Spectrum measurement: **Amplitude Y Scale, Scale/Div.**

History: Added revision A.02.00

## Spectrum - Y-Axis Reference Level

```
:DISPlay:SPECTrum [n] :WINDow [m] :TRACe:Y [:SCALe] :RLEVel  
<power>
```

```
:DISPlay:SPECTrum [n] :WINDow [m] :TRACe:Y [:SCALe] :RLEVel?
```

Sets the amplitude reference level for the y-axis.

n, selects the view, the default is RF envelope.

— n=1, m=1 Spectrum

— n=1, m=2 I/Q Waveform

— n=1, m=2 I and Q Waveform (Basic, W-CDMA, cdma2000)

— n=3, m=1 I/Q Polar (Basic, W-CDMA, cdma2000)

— n=4, m=1 Linear Spectrum (Basic, W-CDMA, cdma2000)

m – selects the window within the view. The default is 1.

Factory Preset: 0 dBm, for Spectrum

Range: -250 to 250 dBm, for Spectrum

Default Unit: dBm, for Spectrum

Remarks: May affect input attenuator setting.

You must be in Basic, cdmaOne, cdma2000, 1xEV-DO, W-CDMA GSM w/EDGE, NADC, or PDC mode. Set the mode with INSTRument:SElect.

Front Panel

Access: When in Spectrum measurement: **Amplitude Y Scale, Ref Level**

History: Added revision A.02.00

## Turn a Trace Display On/Off

```
:DISPlay:TRACe [n] [:STATe] OFF|ON|0|1
```

```
:DISPlay:TRACe [n] [:STATe] ?
```

Controls whether the specified trace is visible or not.

*n* is a sub-opcode that is valid for the current measurement. See the “MEASure Group of Commands” on page 318 for more information about sub-opcodes.

Factory Preset: On

Range: The valid traces and their sub-opcodes are dependent upon the selected measurement. See the following table.

The trace name assignment is independent of the window number.

Remarks: You must be in the Basic, cdmaOne, cdma2000, 1xEV-DO, W-CDMA, GSM (w/EDGE), NADC, or PDC mode to use this command. Use INSTRument:SElect to set the mode

Front Panel

Access: **Display, Display Traces**

Measurement	Available Traces	Markers Available?
ACP - adjacent channel power (Basic, cdmaOne, cdma2000, W-CDMA, NADC, PDC modes)	no traces <i>(n=0)</i> <sup>a</sup> for I/Q points	no markers
CDPower - code domain power (cdmaOne mode)	POWER <i>(n=2)</i> <sup>a</sup> TIMing <i>(n=3)</i> <sup>a</sup> PHASe <i>(n=4)</i> <sup>a</sup> <i>(n=0)</i> <sup>a</sup> for I/Q points	yes
CDPower - code domain power (cdma2000, 1xEV-DO, W-CDMA modes)	<i>(n=0)</i> <sup>a</sup> for I/Q raw data CDPower <i>(n=2)</i> <sup>a</sup> EVM <i>(n=5)</i> <sup>a</sup> MERRor <i>(n=6)</i> <sup>a</sup> PERRor <i>(n=7)</i> <sup>a</sup> SPOWer <i>(n=9)</i> <sup>a</sup> CPOWer <i>(n=10)</i> <sup>a</sup>	yes
CHPower - channel power (Basic, cdmaOne, cdma2000, 1xEV-DO, W-CDMA modes)	SPECTrum <i>(n=2)</i> <sup>a</sup> <i>(n=0)</i> <sup>a</sup> for I/Q raw data	no markers

Measurement	Available Traces	Markers Available?
CSPur - spurs close (cdmaOne mode)	SPECtrum ( $n=2$ ) <sup>a</sup> ULIMit ( $n=3$ ) <sup>a</sup>  ( $n=0$ ) <sup>a</sup> for I/Q points	yes
EEVM - EDGE error vector magnitude (EDGE mode)	EVMerror ( $n=2$ ) <sup>a</sup> MERRor ( $n=3$ ) <sup>a</sup> PERRor ( $n=4$ ) <sup>a</sup>  ( $n=0$ ) <sup>a</sup> for I/Q points	yes
EORFspectr - EDGE output RF spectrum (EDGE mode)	RFEMod ( $n=2$ ) <sup>a</sup> RFESwitching ( $n=3$ ) <sup>a</sup> SPEMod ( $n=4$ ) <sup>a</sup> LIMMod ( $n=5$ ) <sup>a</sup>  ( $n=0$ ) <sup>a</sup> for I/Q points	yes, only for a single offset  yes, only for multiple offsets
EPVTime - EDGE power versus time (EDGE mode)	RFENvelope ( $n=2$ ) <sup>a</sup> UMASk ( $n=3$ ) <sup>a</sup> LMASk ( $n=4$ ) <sup>a</sup>  ( $n=0$ ) <sup>a</sup> for I/Q points	yes
ETSPur - EDGE transmit band spurs (EDGE mode)	SPECtrum ( $n=2$ ) <sup>a</sup> ULIMit ( $n=3$ ) <sup>a</sup>  ( $n=0$ ) <sup>a</sup> for I/Q points	yes
EVM - error vector magnitude (NADC, PDC modes)	EVM ( $n=2$ ) <sup>a</sup> MERRor ( $n=3$ ) <sup>a</sup> PERRor ( $n=4$ ) <sup>a</sup>  ( $n=0$ ) <sup>a</sup> for I/Q points	yes
EVMQpsk - QPSK error vector magnitude (cdma2000, 1xEV-DO, W-CDMA modes)	EVM ( $n=2$ ) <sup>a</sup> MERRor ( $n=3$ ) <sup>a</sup> PERRor ( $n=4$ ) <sup>a</sup>  ( $n=0$ ) <sup>a</sup> for I/Q raw data	yes



Measurement	Available Traces	Markers Available?
IM - intermodulation (cdma2000, 1xEV-DO, W-CDMA modes)	SPECTrum ( $n=2$ ) <sup>a</sup>  ( $n=0$ ) <sup>a</sup> for I/Q raw data	yes
MCPower - multi-carrier power (W-CDMA mode)	no traces  ( $n=0$ ) <sup>a</sup> for I/Q points	no markers
OBW - occupied bandwidth (cdmaOne, cdma2000, 1xEV-DO, PDC, W-CDMA modes)	no traces  ( $n=0$ ) <sup>a</sup> for I/Q raw data	no markers
ORFSpectrum - output RF spectrum (GSM, EDGE mode)	RFEMod ( $n=2$ ) <sup>a</sup> RFESwitching ( $n=3$ ) <sup>a</sup> SPEMod ( $n=4$ ) <sup>a</sup> LIMMod ( $n=5$ ) <sup>a</sup>  ( $n=0$ ) <sup>a</sup> for I/Q points	yes, only for a single offset    yes, only for multiple offsets
PFERror - phase and frequency error (GSM, EDGE mode)	PERRor ( $n=2$ ) <sup>a</sup> PFERror ( $n=3$ ) <sup>a</sup> RFENvelope ( $n=4$ ) <sup>a</sup>  ( $n=0$ ) <sup>a</sup> for I/Q points	yes
PStatistic - power statistics CCDF (Basic, cdma2000, 1xEV-DO, W-CDMA modes)	MEASured ( $n=2$ ) <sup>a</sup> GAUSian ( $n=3$ ) <sup>a</sup> REFerence ( $n=4$ ) <sup>a</sup>  ( $n=0$ ) <sup>a</sup> for I/Q points	yes
PVTime - power versus time (GSM, EDGE, 1xEV-DO modes)	( $n=0$ ) <sup>a</sup> for I/Q raw data  RFENvelope ( $n=2$ ) <sup>a</sup> UMASk ( $n=3$ ) <sup>a</sup> LMASk ( $n=4$ ) <sup>a</sup>	yes

Measurement	Available Traces	Markers Available?
RHO - modulation quality (cdmaOne, cdma2000, W-CDMA mode)	(n=0) <sup>a</sup> for I/Q raw data EVM (n=2) <sup>a</sup> MERRor (n=3) <sup>a</sup> PERRor (n=4) <sup>a</sup> (n=5) <sup>a</sup> for I/Q corrected trace data	yes
RHO - modulation quality (1xEV-DO mode)	(n=0) <sup>a</sup> for I/Q raw data (n=1) <sup>a</sup> for various summary results EVM (n=2) <sup>a</sup> MERRor (n=3) <sup>a</sup> PERRor (n=4) <sup>a</sup> (n=5) <sup>a</sup> for I/Q corrected trace data	yes
SEMask - spectrum emissions mask (cdma2000, 1xEV-DO, W-CDMA mode)	SPECtrum (n=2) <sup>a</sup> (n=0) <sup>a</sup> for I/Q raw data	yes
TSPur - transmit band spurs (GSM, EDGE mode)	SPECtrum (n=2) <sup>a</sup> ULIMit (n=3) <sup>a</sup> (n=0) <sup>a</sup> for I/Q points	yes
TXPower - transmit power (GSM, EDGE mode)	RFENvelope (n=2) <sup>a</sup> IQ (n=8) <sup>a</sup> (n=0) <sup>a</sup> for I/Q points	yes
SPECtrum - (frequency domain) (all modes)	IQ (n=3) <sup>a</sup> SPECtrum (n=4) <sup>a</sup> ASpectrum (n=7) <sup>a</sup> (n=0) <sup>a</sup> for I/Q raw data	yes

Measurement	Available Traces	Markers Available?
WAVEform - (time domain) (all modes)	RFENvelope ( $n=2$ ) <sup>a</sup> (also for Signal Envelope trace)  IQ ( $n=5$ ) <sup>a</sup>  ( $n=0$ ) <sup>a</sup> for I/Q raw data	yes

a. The  $n$  number indicates the sub-opcode that corresponds to this trace. Detailed descriptions of the trace data can be found in the MEASure subsystem documentation by looking up the sub-opcode for the appropriate measurement.

## Waveform - Y-Axis Scale/Div

`:DISPlay:WAVEform [n] :WINDow [m] :TRACe:Y[:SCALE]:PDIVision <power>`

`:DISPlay:WAVEform [n] :WINDow [m] :TRACe:Y[:SCALE]:PDIVision?`

Sets the scale per division for the y-axis.

$n$ , selects the view, the default is RF envelope.

$n=1$ ,  $m=1$  RF envelope

$n=2$ ,  $m=1$  I/Q Waveform

$n=4$ ,  $m=1$  I/Q Polar (Basic, W-CDMA, cdma2000)

$m$ , selects the window within the view. The default is 1.

Factory Preset: 10 dBm, for RF envelope

Range: .1 dB to 20 dB, for RF envelope

Default Unit: dBm, for RF envelope

Remarks: May affect input attenuator setting.

You must be in Basic, cdmaOne, cdma2000, 1xEV-DO, W-CDMA GSM w/EDGE, NADC, or PDC mode. Set the mode with INSTRument:SElect.

Front Panel

Access: When in Waveform measurement: **Amplitude Y Scale, Scale/Div.**

History: Added revision A.02.00

## Waveform - Y-Axis Reference Level

`:DISPlay:WAVeform [n] :WINDow [m] :TRACe:Y [:SCALe] :RLEVel  
<power>`

`:DISPlay:WAVeform [n] :WINDow [m] :TRACe:Y [:SCALe] :RLEVel?`

Sets the amplitude reference level for the y-axis.

n, selects the view, the default is RF envelope.

n=1, m=1 RF envelope

n=2, m=1 I/Q Waveform

n=4, m=1 I/Q Polar (Basic, W-CDMA, cdma2000)

m, selects the window within the view. The default is 1.

Factory Preset: 0 dBm, for RF envelope

Range: -250 to 250 dBm, for RF envelope

Default Unit: dBm, for RF envelope

Remarks: May affect input attenuator setting.

You must be in Basic, cdmaOne, cdma2000, 1xEV-DO, W-CDMA GSM w/EDGE, NADC, or PDC mode. Set the mode with INSTRument:SElect.

Front Panel

Access: When in Waveform measurement: **Amplitude Y Scale, Ref Level**

History: Added revision A.02.00

---

## FETCh Subsystem

The FETCh? queries are used with several other commands to control the measurement process. These commands are described in the section on the “[MEASure Group of Commands](#)” on page 318. These commands apply only to measurements found in the MEASURE menu.

This command puts selected data from the most recent measurement into the output buffer (new data is initiated/measured). Use FETCh if you have already made a good measurement and you want to look at several types of data (different [n] values) from the single measurement. FETCh saves you the time of re-making the measurement. You can only fetch results from the measurement that is currently active.

If you need to make a new measurement, use the READ command, which is equivalent to an INITiate[:IMMEDIATE] followed by a FETCh.

:FETCh <meas>? will return valid data only when the measurement is in one of the following states:

- idle
- initiated
- paused

### Fetch the Current Measurement Results

**:FETCh: <measurement> [n] ?**

A FETCh? command must specify the desired measurement. It will return the valid results that are currently available, but will not initiate the taking of any new data. You can only fetch results from the measurement that is currently selected. The code number n selects the kind of results that will be returned. The available measurements and data results are described in the “[MEASure Group of Commands](#)” on page 318.

---

## FORMat Subsystem

The FORMat subsystem sets a data format for transferring numeric and array information. The TRACe[:DATA] command is affected by FORMat subsystem commands.

### Byte Order

**:FORMat:BORDER** NORMAl | SWAPped

**:FORMat:BORDER?**

Selects the binary data byte order for numeric data transfer. In normal mode the most significant byte is sent first. In swapped mode the least significant byte is first. (PCs use the swapped order.) Binary data byte order functionality does not apply to ASCII.

Factory Preset: Normal

### Numeric Data format

**:FORMat[:DATA]** ASCii | REAL, 32 | REAL, 64

**:FORMat[:DATA]?**

For PSA Spectrum Analysis mode only:

**:FORMat[:TRACe] [:DATA]**

ASCii | INTeger, 16 | INTeger, 32 | REAL, 32 | REAL, 64 | UINTegeR, 16

**:FORMat[:TRACe] [:DATA]?**

This command controls the format of data output, that is, data transfer across any remote port. The REAL and ASCII formats will format trace data in the current amplitude units.

The format of state data cannot be changed. It is always in a machine readable format only.

ASCII - Amplitude values are in ASCII, in amplitude units, separated by commas. ASCII format requires more memory than the binary formats. Therefore, handling large amounts of this type of data, will take more time and storage space.

Integer,16 - Binary 16-bit integer values in internal units (dBm), in a definite length block. \*\*PSA, SA mode only.

Integer,32 - Binary 32-bit integer values in internal units (dBm), in a definite length block.

Real,32 (or 64) - Binary 32-bit (or 64-bit) real values in amplitude unit, in a definite length block. Transfers of real data are done in a binary block format.

UINTEger,16 - Binary 16-bit unsigned integer that is uncorrected ADC values, in a definite length block. This format is almost never applicable with current data.

A definite length block of data starts with an ASCII header that begins with # and indicates how many additional data points are following in the block. Suppose the header is #512320.

- The first digit in the header (5) tells you how many additional digits/bytes there are in the header.
- The 12320 means 12 thousand, 3 hundred, 20 data bytes follow the header.
- Divide this number of bytes by your selected data format bytes/point, either 8 (for real 64), or 4 (for real 32). In this example, if you are using real 64 then there are 1540 points in the block.

Example:       FORM REAL,64

Factory Preset: Real,32 for Spectrum Analysis mode

                  ASCII for Basic, cdmaOne, cdma2000, W-CDMA, GSM  
                  with EDGE, NADC, PDC modes

Remarks:       The acceptable settings for this command changes for  
                  different modes.

---

## INITiate Subsystem

The INITiate subsystem is used to initiate a trigger for a measurement. They only initiate measurements from the MEASURE front panel key or the “MEASURE Group of Commands” on page 318. Refer to the TRIGGER and ABORT subsystems for related commands.

### Take New Data Acquisition for Selected Measurement

**:INITiate:<measurement\_name>**

This command initiates a trigger cycle for the measurement specified. The available measurement names are described in the MEASURE subsystem. It also holds off additional commands on GPIB until the acquisition is complete. So if it is followed by a FETCH command, valid data will be returned.

If your selected measurement is currently active (in the idle state) it triggers the measurement, assuming the trigger conditions are met. Then it completes one trigger cycle. Depending upon the measurement and the number of averages, there may be multiple data acquisitions, with multiple trigger events, for one full trigger cycle.

If your selected measurement is not currently active it will change to the measurement in your INIT:<meas\_name> command and initiate a trigger cycle.

Example:       INIT:ACP

### Continuous or Single Measurements

**:INITiate:CONTinuous OFF|ON|0|1**

**:INITiate:CONTinuous?**

Selects whether a trigger is continuously initiated or not. Each trigger initiates a single, complete, measurement operation.

When set to ON another trigger cycle is initiated at the completion of each measurement.

When set to OFF, the trigger system remains in the “idle” state until an INITiate[:IMMEDIATE] command is received. On receiving the INITiate[:IMMEDIATE] command, it will go through a single trigger/measurement cycle, and then return to the “idle” state.

Example:       INIT:CONT ON

Factory Preset: On

\*RST:           Off (recommended for remote operation)



Front Panel  
 Access: **Meas Control, Measure Cont Single**

## Take New Data Acquisitions

**:INITiate[:IMMEDIATE]**

The instrument must be in the single measurement mode. If INIT:CONT is ON, then the command is ignored. The desired measurement must be selected and waiting. The command causes the system to exit the “waiting” state and go to the “initiated” state.

The trigger system is initiated and completes one full trigger cycle. It returns to the “waiting” state on completion of the trigger cycle. Depending upon the measurement and the number of averages, there may be multiple data acquisitions, with multiple trigger events, for one full trigger cycle.

This command triggers the instrument, if external triggering is the type of trigger event selected. Otherwise, the command is ignored. Use the TRIGger[:SEquence]:SOURce EXT command to select the external trigger.

Example: INIT:IMM

Remarks: See also the \*TRG command and the TRIGger subsystem.

Front Panel  
 Access: **Meas Control, Measure Cont Single**

## Restart the Measurement

**:INITiate:REStart**

This command applies to measurements found in the MEASURE menu. It restarts the current measurement from the “idle” state regardless of its current operating state. It is equivalent to:

INITiate[:IMMEDIATE]

ABORt (for continuous measurement mode)

Example: INIT:REST

Front Panel  
 Access: **Restart**  
 or  
**Meas Control, Restart**



## INSTrument Subsystem

This subsystem includes commands for querying and selecting instrument measurement (personality option) modes.

### Catalog Query

**:INSTrument:CATalog?**

Returns a comma separated list of strings which contains the names of all the installed applications. These names can only be used with the **INST:SELECT** command.

Example:       INST:CAT?

Query response: "CDMA"4,"PNOISE"14

### Select Application by Number

**:INSTrument:NSElect <integer>**

**:INSTrument:NSElect?**

Select the measurement mode by its instrument number. The actual available choices depends upon which applications are installed in the instrument.

- 1 = SA
- 4 = CDMA (cdmaOne)
- 5 = NADC
- 6 = PDC
- 8 = BASIC
- 9 = WCDMA (3GPP)
- 10 = CDMA2K (cdma2000)
- 13 = EDGE GSM
- 14 = PNOISE (phase noise)

**NOTE**

If you are using the SCPI status registers and the analyzer mode is changed, the status bits should be read, and any errors resolved, prior to switching modes. Error conditions that exist prior to switching modes cannot be detected using the condition registers after the mode change. This is true unless they recur after the mode change, although transitions of these conditions can be detected using the event registers.

Changing modes resets all SCPI status registers and mask registers to their power-on defaults. Hence, any event or condition register masks must be re-established after a mode change. Also note that the power up status bit is set by any mode change, since that is the default state

---

after power up.

Example:       INST:NSEL 4

Factory Preset: Persistent state with factory default of 1

Range:         1 to x, where x depends upon which applications are installed.

Front Panel

Access:        **Mode**

## Select Application

PSA Series:

```
:INSTrument [:SElect]
SA | PNOISE | BASIC | CDMA | CDMA2K | EDGE GSM | NADC | PDC | WCDMA
:INSTrument [:SElect] ?
```

Select the measurement mode. The actual available choices depend upon which modes (measurement applications) are installed in the instrument. A list of the valid choices is returned with the INST:CAT? query.

Once an instrument mode is selected, only the commands that are valid for that mode can be executed.

- 1 = SA
- 4 = CDMA (cdmaOne)
- 5 = NADC
- 6 = PDC
- 8 = BASIC
- 9 = WCDMA (3GPP)
- 10 = CDMA2K (cdma2000)
- 13 = EDGE GSM
- 14 = PNOISE (phase noise)

---

### NOTE

If you are using the status bits and the analyzer mode is changed, the status bits should be read, and any errors resolved, prior to switching modes. Error conditions that exist prior to switching modes cannot be detected using the condition registers after the mode change. This is true unless they recur after the mode change, although transitions of these conditions can be detected using the event registers.

Changing modes resets all SCPI status registers and mask registers to their power-on defaults. Hence, any event or condition register masks must be re-established after a mode change. Also note that the power up status bit is set by any mode change, since that is the default state after power up.

---

Example: ESA Series instruments: INST:SEL 'CDMA'

Example: PSA Series instruments: INST:SEL CDMA

Factory Preset: Persistent state with factory default of Spectrum Analyzer mode

Front Panel

Access: **Mode**

---

## MEASure Group of Commands

This group includes the CONFigure, FETCh, MEASure, and READ commands that are used to make measurements and return results. The different commands can be used to provide fine control of the overall measurement process, like changing measurement parameters from their default settings. Most measurements should be done in single measurement mode, rather than measuring continuously.

The SCPI default for the format of any data output is ASCII. The format can be changed to binary with FORMat:DATA which transports faster over the bus.

### CONFigure, FETCh, MEASure, READ Interactions

These commands are all inter-related. See [Figure 5-3 on page 319](#).

#### Measure Commands

**:MEASure:<measurement> [n] ?**

This is a fast single-command way to make a measurement using the factory default instrument settings. These are the settings and units that conform to the Mode Setup settings (e.g. radio standard) that you have currently selected.

- Stops the current measurement (if any) and sets up the instrument for the specified measurement using the factory defaults
- Initiates the data acquisition for the measurement
- Blocks other SCPI communication, waiting until the measurement is complete before returning results.
- After the data is valid it returns the scalar results, or the trace data, for the specified measurement. The type of data returned may be defined by an [n] value that is sent with the command.

The scalar measurement results will be returned if the optional [n] value is not included, or is set to 1. If the [n] value is set to a value other than 1, the selected trace data results will be returned. See each command for details of what types of scalar results or trace data results are available.

ASCII is the default format for the data output. (Older versions of Spectrum Analysis and Phase Noise mode measurements only use ASCII.) The binary data formats should be used for handling large blocks of data since they are smaller and faster than the ASCII format. Refer to the FORMat:DATA command for more information.

If you need to change some of the measurement parameters from the factory default settings you can set up the measurement with the

CONFigure command. Use the commands in the SENSE:<measurement> and CALCulate:<measurement> subsystems to change the settings. Then you can use the READ? command to initiate the measurement and query the results. See Figure 5-3.

If you need to repeatedly make a given measurement with settings other than the factory defaults, you can use the commands in the SENSE:<measurement> and CALCulate:<measurement> subsystems to set up the measurement. Then use the READ? command to initiate the measurement and query results.

Measurement settings persist if you initiate a different measurement and then return to a previous one. Use READ:<measurement>? if you want to use those persistent settings. If you want to go back to the default settings, use MEASure:<measurement>?.

**Figure 5-3 Measurement Group of Commands**

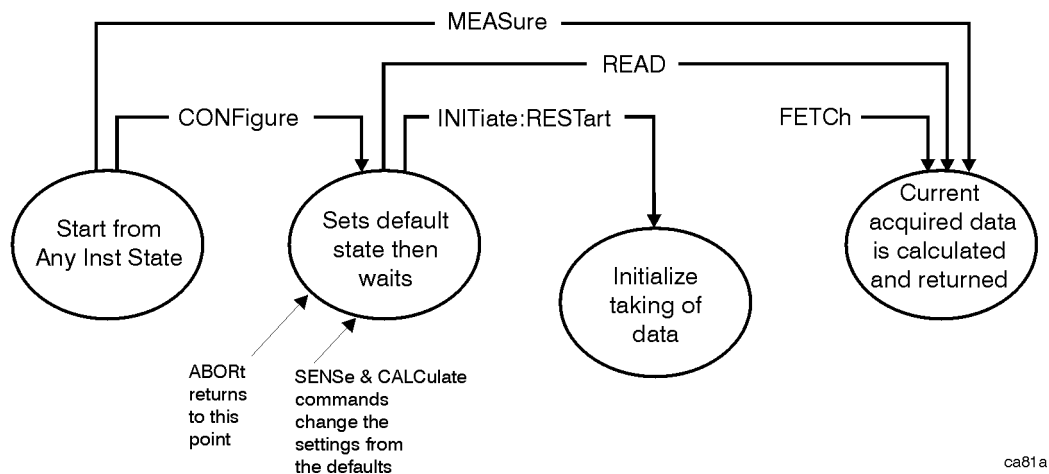

### Configure Commands

**:CONFigure:<measurement>**

This command stops the current measurement (if any) and sets up the instrument for the specified measurement using the factory default instrument settings. It sets the instrument to single measurement mode but should not initiate the taking of measurement data unless INIT:CONTinuous is ON. After you change any measurement settings, the READ command can be used to initiate a measurement without changing the settings back to their defaults.

The CONFigure? query returns the current measurement name.

## Fetch Commands

**:FETCh:<measurement> [n] ?**

This command puts selected data from the most recent measurement into the output buffer. Use FETCh if you have already made a good measurement and you want to return several types of data (different [n] values, e.g. both scalars and trace data) from a single measurement. FETCh saves you the time of re-making the measurement. You can only FETCh results from the measurement that is currently active, it will not change to a different measurement.

If you need to get new measurement data, use the READ command, which is equivalent to an INITiate followed by a FETCh.

The scalar measurement results will be returned if the optional [n] value is not included, or is set to 1. If the [n] value is set to a value other than 1, the selected trace data results will be returned. See each command for details of what types of scalar results or trace data results are available. The binary data formats should be used for handling large blocks of data since they are smaller and transfer faster than the ASCII format. (FORMat:DATA)

FETCh may be used to return results other than those specified with the original READ or MEASure command that you sent.

## Read Commands

**:READ:<measurement> [n] ?**

- Does not preset the measurement to the factory default settings. For example, if you have previously initiated the ACP measurement and you send READ:ACP? it will initiate a new measurement using the same instrument settings.
- Initiates the measurement and puts valid data into the output buffer. If a measurement other than the current one is specified, the instrument will switch to that measurement before it initiates the measurement and returns results.

For example, suppose you have previously initiated the ACP measurement, but now you are running the channel power measurement. Then you send READ:ACP? It will change from channel power back to ACP and, using the previous ACP settings, will initiate the measurement and return results.

- Blocks other SCPI communication, waiting until the measurement is complete before returning the results

If the optional [n] value is not included, or is set to 1, the scalar measurement results will be returned. If the [n] value is set to a value other than 1, the selected trace data results will be returned. See each command for details of what types of scalar results or trace data results are available. The binary data formats should be used



when handling large blocks of data since they are smaller and faster than the ASCII format. (FORMat:DATA)

## Initiate Commands

**:INITiate:<measurement>**

This command is not available for measurements in all the instrument modes:

- Initiates a trigger cycle for the specified measurement, but does not output any data. You must then use the FETCh<meas> command to return data. If a measurement other than the current one is specified, the instrument will switch to that measurement and then initiate it.

For example, suppose you have previously initiated the ACP measurement, but now you are running the channel power measurement. If you send INIT:ACP? it will change from channel power to ACP and will initiate an ACP measurement.

- Does not change any of the measurement settings. For example, if you have previously started the ACP measurement and you send INIT:ACP? it will initiate a new ACP measurement using the same instrument settings as the last time ACP was run.
- If your selected measurement is currently active (in the idle state) it triggers the measurement, assuming the trigger conditions are met. Then it completes one trigger cycle. Depending upon the measurement and the number of averages, there may be multiple data acquisitions, with multiple trigger events, for one full trigger cycle. It also holds off additional commands on GPIB until the acquisition is complete.

## Adjacent Channel Power Ratio (ACP) Measurement

This measures the total rms power in the specified channel and in 5 offset channels. You must be in cdmaOne, cdma2000, W-CDMA, NADC or PDC mode to use these commands. Use INSTRument:SElect to set the mode.

The general functionality of CONFigure, FETCh, MEASure, and READ are described at the beginning of this section. See the SENSE:ACP commands for more measurement related commands.

```
:CONFigure:ACP
:INITiate:ACP
:FETCh:ACP [n] ?
:READ:ACP [n] ?
:MEASure:ACP [n] ?
```

For Basic mode, a channel frequency and power level can be defined in the command statement to override the default standard setting. A comma must precede the power value as a place holder for the frequency, when no frequency is sent.

Front Panel

Access: **Measure, ACPor ACPR**

After the measurement is selected, press **Restore Meas Defaults** to restore factory defaults.

### Measurement Results Available

Measurement Type	n	Results Returned
	0	Returns unprocessed I/Q trace data, as a series of trace point values, in volts. The I values are listed first in each pair, using the 0 through even-indexed values. The Q values are the odd-indexed values.
	n=1 (or not specified) NADC and PDC mode	Returns 22 scalar results, in the following order: <ol style="list-style-type: none"> <li>1. Center frequency – absolute power (dBm)</li> <li>2. Center frequency – absolute power (W)</li> <li>3. Negative offset frequency (1) – relative power (dB)</li> <li>4. Negative offset frequency (1) – absolute power (dBm)</li> <li>5. Positive offset frequency (1) – relative power (dB)</li> <li>6. Positive offset frequency (1) – absolute power (dBm)</li> </ol> <p style="text-align: center;">. . .</p> <ol style="list-style-type: none"> <li>1. Positive offset frequency (5) – relative power (dB)</li> <li>2. Positive offset frequency (5) – absolute power (dBm)</li> </ol>

Measurement Type	n	Results Returned
Total power reference	n=1 (or not specified) Basic, cdmaOne, cdma2000, W-CDMA mode	Returns 24 scalar results, in the following order: <ol style="list-style-type: none"> <li>1. Center frequency - relative power (dB)</li> <li>2. Center frequency - absolute power (dBm)</li> <li>3. Center frequency - relative power (dB) (same as value 1)</li> <li>4. Center frequency - absolute power (dBm) (same as value 2)</li> <li>5. Negative offset frequency (1) - relative power (dB),</li> <li>6. Negative offset frequency (1) - absolute power (dBm)</li> <li>7. Positive offset frequency (1) - relative power (dB)</li> <li>8. Positive offset frequency (1) - absolute power (dBm)</li> </ol> <p style="text-align: center;">. . .</p> <ol style="list-style-type: none"> <li>1. Positive offset frequency (5) - relative power (dB)</li> <li>2. Positive offset frequency (5) - absolute power (dBm)</li> </ol> <hr/> <p><b>NOTE</b> Center frequency relative power is relative to the center frequency absolute power and therefore, is always equal to 0.00 dB.</p>
Power spectral density reference	n=1 (or not specified) Basic, cdmaOne, cdma2000, W-CDMA mode	Returns 24 scalar results, in the following order: <ol style="list-style-type: none"> <li>1. Center frequency - relative power (dB)</li> <li>2. Center frequency - absolute power (dBm/Hz)</li> <li>3. Center frequency - relative power (dB) (same as value 1)</li> <li>4. Center frequency - absolute power (dBm/Hz) (same as value 2)</li> <li>5. Negative offset frequency (1) - relative power (dB)</li> <li>6. Negative offset frequency (1) - absolute power (dBm/Hz)</li> <li>7. Positive offset frequency (1) - relative power (dB)</li> <li>8. Positive offset frequency (1) - absolute power (dBm/Hz)</li> </ol> <p style="text-align: center;">. . .</p> <ol style="list-style-type: none"> <li>1. Positive offset frequency (5) - relative power (dB)</li> <li>2. Positive offset frequency (5) - absolute power (dBm/Hz)</li> </ol> <hr/> <p><b>NOTE</b> Center frequency relative power is relative to the center frequency absolute power and therefore, is always equal to 0.00 dB.</p>
	2 NADC and PDC mode	Returns 10 scalar values of the pass/fail (0=passed, or 1=failed) results determined by testing the absolute power of the offset frequencies: <ol style="list-style-type: none"> <li>1. Negative offset frequency (1) absolute power</li> <li>2. Positive offset frequency (1) absolute power</li> </ol> <p style="text-align: center;">. . .</p> <ol style="list-style-type: none"> <li>1. Negative offset frequency (5) absolute power</li> <li>2. Positive offset frequency (5) absolute power</li> </ol>

Measurement Type	n	Results Returned
Total power reference	2 Basic, cdmaOne, cdma2000, W-CDMA mode	Returns 11 scalar values (in dBm) corresponding to the total power histogram display. The values are returned in ascending frequency order:  1. Negative offset frequency (5) 2. Negative offset frequency (4) 3. Negative offset frequency (3)  . . .  1. Center frequency 2. Positive offset frequency (1) 3. Positive offset frequency (2)  . . .  1. Positive offset frequency (5)
	3 NADC and PDC mode	Returns 10 scalar values of the pass/fail (0=passed, or 1=failed) results determined by testing the relative power of the offset frequencies:  1. Negative offset frequency (1) relative power 2. Positive offset frequency (1) relative power  . . .  1. Negative offset frequency (5) relative power 2. Positive offset frequency (5) relative power
Power spectral density reference	3 Basic, cdmaOne, cdma2000, W-CDMA mode	Returns 11 scalar values (in dBm/Hz) corresponding to the power spectral density histogram display. The values are returned in ascending frequency order:  1. Negative offset frequency (5) 2. Negative offset frequency (4)  . . .  1. Center frequency 2. Positive offset frequency (1)  . . .  1. Positive offset frequency (5)
	4 NADC and PDC mode	Returns the frequency-domain spectrum trace (data array) for the entire frequency range being measured.  In order to return spectrum data, the ACP display must be in the spectrum view and you must not turn off the spectrum trace.

Measurement Type	n	Results Returned
(For cdma2000 and W-CDMA the data is only available with spectrum display selected)	4 Basic, cdmaOne, cdma2000, W-CDMA mode	<p>Returns the frequency-domain spectrum trace data for the entire frequency range being measured.</p> <p>With the spectrum view selected (DISPlay:ACP:VIEW SPECTrum) and the spectrum trace on (SENSe:ACP:SPECTrum:ENABLE):</p> <ul style="list-style-type: none"> <li>• In FFT mode (SENSe:ACP:SWEep:TYPE FFT) the number of trace points returned are 343 (cdma2000) or 1715 (W-CDMA). This is with the default span of 5 MHz (cdma2000) or 25 MHz (W-CDMA). The number of points also varies if another offset frequency is set.</li> <li>• In sweep mode (SENSe:ACP:SWEep:TYPE SWEep), the number of trace points returned is 601 (for cdma2000 or W-CDMA) for any span.</li> </ul> <p>With bar graph display selected, one point of -999.0 will be returned.</p>
Total power reference	5 Basic, cdmaOne, cdma2000, W-CDMA mode	<p>Returns 12 scalar values (in dBm) of the absolute power of the center and the offset frequencies:</p> <ol style="list-style-type: none"> <li>1. Upper adjacent chan center frequency</li> <li>2. Lower adjacent chan center frequency</li> <li>3. Negative offset frequency (1)</li> <li>4. Positive offset frequency (1)</li> </ol> <p>...</p> <ol style="list-style-type: none"> <li>1. Negative offset frequency (5)</li> <li>2. Positive offset frequency (5)</li> </ol>
Power spectral density reference	5 Basic, cdmaOne, cdma2000, W-CDMA mode	<p>Returns 12 scalar values (in dBm/Hz) of the absolute power of the center and the offset frequencies:</p> <ol style="list-style-type: none"> <li>1. Upper adjacent chan center frequency</li> <li>2. Lower adjacent chan center frequency</li> <li>3. Negative offset frequency (1)</li> <li>4. Positive offset frequency (1)</li> </ol> <p>...</p> <ol style="list-style-type: none"> <li>1. Negative offset frequency (5)</li> <li>2. Positive offset frequency (5)</li> </ol>

Measurement Type	n	Results Returned
Total power reference	6 Basic, cdmaOne, cdma2000, W-CDMA mode	Returns 12 scalar values (total power in dB) of the power relative to the carrier at the center and the offset frequencies:  1. Upper adjacent chan center frequency 2. Lower adjacent chan center frequency 3. Negative offset frequency (1) 4. Positive offset frequency (1) 5. Negative offset frequency (5)  . . .  1. Negative offset frequency (5) 2. Positive offset frequency (5)
Power spectral density reference	6 Basic, cdmaOne, cdma2000, W-CDMA mode	Returns 12 scalar values (power spectral density in dB) of the power relative to the carrier at the center and offset frequencies:  1. Upper adjacent chan center frequency 2. Lower adjacent chan center frequency 3. Negative offset frequency (1) 4. Positive offset frequency (1)  . . .  1. Negative offset frequency (5) 2. Positive offset frequency (5)
Total power reference	7 Basic, cdmaOne, cdma2000, W-CDMA mode	Returns 12 scalar values of the pass/fail (0=passed, or 1=failed) results determined by testing the absolute power limit of the center and offset frequencies (measured as total power in dB):  1. Upper adjacent chan center frequency 2. Lower adjacent chan center frequency 3. Negative offset frequency (1) 4. Positive offset frequency (1)  . . .  1. Negative offset frequency (5) 2. Positive offset frequency (5)

Measurement Type	n	Results Returned
Power spectral density reference	7 Basic, cdmaOne, cdma2000, W-CDMA mode	Returns 12 scalar values of the pass/fail (0=passed, or 1=failed) results determined by testing the absolute power limit of the center and offset frequencies (measured as power spectral density in dB):  1. Upper adjacent chan center frequency 2. Lower adjacent chan center frequency 3. Negative offset frequency (1) 4. Positive offset frequency (1)  . . .  1. Negative offset frequency (5) 2. Positive offset frequency (5)
Total power reference	8 Basic, cdmaOne, cdma2000, W-CDMA mode	Returns 12 scalar values of the pass/fail (0=passed, or 1=failed) results determined by testing the power limit relative to the center frequency (measured as total power spectral in dB):  1. Upper adjacent chan center frequency 2. Lower adjacent chan center frequency 3. Negative offset frequency (1) 4. Positive offset frequency (1)  . . .  1. Negative offset frequency (5) 2. Positive offset frequency (5)
Power spectral density reference	8 Basic, cdmaOne, cdma2000, W-CDMA mode	Returns 12 scalar values of the pass/fail (0=passed, or 1=failed) results determined by testing the power limit relative to the center frequency (measured as power spectral density in dB):  1. Upper adjacent chan center frequency 2. Lower adjacent chan center frequency 3. Negative offset frequency (1) 4. Positive offset frequency (1)  . . .  1. Negative offset frequency (5) 2. Positive offset frequency (5)

## Code Domain Measurement

This measures the power levels of the spread channels in RF channel(s). You must be in the cdmaOne, cdma2000, W-CDMA, or 1xEV-DO mode to use these commands. Use INSTRument:SElect to set the mode.

The general functionality of CONFigure, FETCh, MEASure, and READ are described at the beginning of this section. See the SENSE:CDPower commands for more measurement related commands.

```
:CONFigure:CDPower
:INITiate:CDPower
:FETCh:CDPower [n] ?
:READ:CDPower [n] ?
:MEASure:CDPower [n] ?
```

Front Panel

Access: **Measure, Code Domain**

After the measurement is selected, press **Restore Meas Defaults** to restore factory defaults.

### Measurement Results Available

n	Results Returned
0	Returns unprocessed I/Q trace data, as a series of trace point values, in volts. The I values are listed first in each pair, using the 0 through even-indexed values. The Q values are the odd-indexed values.



n	Results Returned
<p>n=1 (or not specified) cdmaOne mode</p>	<p>Returns the following 25 scalar results:</p> <ol style="list-style-type: none"> <li>1. <b>Time offset</b> is a floating point number with units of seconds. This is the time delay of the even second clock with respect to the start of the short code PN sequences, at offsets from the 15 zeros in the characteristic phase of the sequences.</li> <li>2. <b>Frequency error</b> is a floating point number (in Hz) of the frequency error in the measured signal. This error is based on the linear best fit of the uncorrected measured phase.</li> <li>3. <b>Carrier feedthrough</b> is a floating point number (in dB) of the dc offset, of I and Q, from the origin.</li> <li>4. <b>Pilot power</b> is a floating point number with units of dB. It is the relative power of the pilot channel (Walsh code 0) with respect to the carrier power.</li> <li>5. <b>Paging power</b> is a floating point number with units of dB. It is the relative power of the paging channel (Walsh code 1) with respect to the carrier power.</li> <li>6. <b>Sync power</b> is a floating point number with units of dB. It is the relative power of the sync channel (Walsh code 32) with respect to the carrier power.</li> <li>7. <b>Average traffic power</b> is a floating point number with units of dB. It is the average relative power of the active traffic channels with respect to the carrier power. Traffic channels are defined as all of the Walsh codes except Walsh 0,1,32. A traffic channel is active if its coding power is greater than the active threshold parameter which you have selected.</li> <li>8. <b>Maximum inactive traffic power</b> is a floating point number with units of dB. It is the maximum relative power of an inactive traffic channel with respect to the carrier power. Traffic channels are defined as all of the Walsh codes except Walsh 0,1,32. A traffic channel is inactive if its coding power is less than the active threshold parameter which you have selected.</li> <li>9. <b>Average inactive traffic power</b> is a floating point number with units of dB. It is the average relative power of the inactive traffic channels with respect to the carrier power. Traffic channels are defined as all of the Walsh codes except Walsh 0,1,32. A traffic channel is inactive if its coding power is less than the active threshold parameter which you have selected.</li> <li>10. <b>Marker Values</b> The last 16 measurement results are the current values for all four available markers. The values are zero for any marker that is not active. <ol style="list-style-type: none"> <li>10. Marker 1 position (code number)</li> <li>11, Marker 1 power level</li> <li>12. Marker 1 time value</li> <li>13. Marker 1 phase value</li> <li>...</li> <li>25. Marker 4 phase value</li> </ol> </li> </ol>

n	Results Returned
n=1 (or not specified) cdma2000 mode	<p>Returns the following 19 scalar results:</p> <ol style="list-style-type: none"> <li>1. <b>RMS symbol EVM</b> is a floating point number (in percent) of the EVM over the entire measurement area.</li> <li>2. <b>Peak symbol EVM</b> is a floating point number (in percent) of the peak EVM in the measurement area.</li> <li>3. <b>Symbol magnitude error</b> is a floating point number (in percent) of the average magnitude error over the entire measurement area.</li> <li>4. <b>Symbol phase error</b> is a floating point number (in degrees) of the average phase error over the entire measurement area.</li> <li>5. <b>Total power</b> is a floating point number (in dBm) of the total RF power over the measurement interval.</li> <li>6. <b>Average power</b> is a floating point number (in dBm) of the power in the entire slot, for the selected code, averaged over the measurement interval.</li> <li>7. <b>Total active power</b> is a floating point number (in dB or dBm depending on the measurement type) of the sum of the active power.</li> <li>8. <b>Pilot power</b> is a floating point number (in dB or dBm depending on the measurement type) of the average power of the Pilot code.</li> <li>9. <b>Sync power</b> is a floating point number (in dB or dBm depending on the measurement type) of the average power of the Sync code. In the MS mode, the value returned is -999.</li> <li>10. <b>Maximum active traffic power</b> is a floating point number (in dB or dBm depending on the measurement type) of the maximum average power of the active code. If no active code is detected the value returned is -999. In the MS mode, the value returned is -999.</li> <li>11. <b>Average active traffic power</b> is a floating point number (in dB or dBm depending on the measurement type) of the average power of all the active traffic channels. If no active code is detected the value returned is -999. In the MS mode, the value returned is -999.</li> <li>12. <b>Maximum inactive traffic power</b> is a floating point number (in dB or dBm depending on the measurement type) of the maximum average power of the inactive traffic channels. In the MS mode, the value returned is -999.</li> <li>13. <b>Average inactive traffic power</b> is a floating point number (in dB or dBm depending on the measurement type) of the average power of the inactive traffic channels. In the MS mode, the value returned is -999.</li> <li>14. <b>Number of active channel</b> In the MS mode, the value returned is -999.</li> </ol>

n	Results Returned
n=1 (or not specified) cdma2000 mode (continued)	<ol style="list-style-type: none"> <li data-bbox="479 285 1409 380">1. <b>I channel average active power</b> is a floating point number (in dB or dBm depending on the measurement type) of the average power of the active I channels. In the BS mode, the value returned is –999.</li> <li data-bbox="479 394 1409 520">2. <b>I channel maximum inactive power</b> is a floating point number (in dB or dBm depending on the measurement type) of the maximum average power of the inactive I channels. In the BS mode, the value returned is –999.</li> <li data-bbox="479 535 1409 630">3. <b>Q channel average active power</b> is a floating point number (in dB or dBm depending on the measurement type) of the average power of the active Q channels. In the BS mode, the value returned is –999.</li> <li data-bbox="479 644 1409 770">4. <b>Q channel maximum inactive power</b> is a floating point number (in dB or dBm depending on the measurement type) of the maximum average power of the inactive Q channels. In the BS mode, the value returned is –999.</li> <li data-bbox="479 785 1409 882">5. <b>Time between trigger to PN Offset</b> is a floating point number (in <math>\mu</math>s) of the time from the trigger point to the PN Offset. In the MS mode, the value returned is –999.</li> </ol>

n	Results Returned
n=1 (or not specified) W-CDMA mode	<p>Returns the following 31 scalar results:</p> <ol style="list-style-type: none"> <li>1. <b>RMS symbol EVM</b> is a floating point number (in percent) of the EVM over the entire measurement area.</li> <li>2. <b>Peak symbol EVM</b> is a floating point number (in percent) of the peak EVM in the measurement area.</li> <li>3. <b>Symbol magnitude error</b> is a floating point number (in percent) of the average magnitude error over the entire measurement area.</li> <li>4. <b>Symbol phase error</b> is a floating point number (in degrees) of the average phase error over the entire measurement area.</li> <li>5. <b>Total power</b> is a floating point number (in dBm) of the total RF power over the measurement interval.</li> <li>6. <b>Channel power</b> is a floating point number (in dBc or dBm depending on the measurement type, see below) of the power in the entire slot, for the selected code, averaged over the measurement interval.             NOTE: When measurement type = rel, then the value displayed is in units of dBc, and the relative power is calculated as the ratio of the Channel Power to the Total Power (parameter 5 above).</li> <li>7. <b>tDPCH</b> is a floating point number (in 256 chips) of dedicated physical channel (DPCH) delay time from the reference.</li> <li>8. <b>Total power over a slot</b> is a floating point number (in dBm) of total RF power over the measurement interval.</li> <li>9. <b>Total active power</b> is a floating point number (in dB or dBm depending on the measurement type) of sum of the active power.</li> <li>10. <b>Pilot power</b> is a floating point number (in dB or dBm depending on the measurement type) of the average power of the CPICH code relative to the total slot power. In the MS mode, the value returned is -999. (SCH is excluded.)</li> <li>11. <b>Maximum active traffic power</b> is a floating point number (in dB or dBm depending on the measurement type) of the maximum average power of the active traffic channels. If no active code is detected the value returned is -999. In the MS mode, the value returned is -999. (SCH is excluded.)</li> <li>12. <b>Average active traffic power</b> is a floating point number (in dB or dBm depending on the measurement type) of the average power of all the active traffic channels. If no active code is detected the value returned is -999. In the MS mode, the value returned is -999. (SCH is excluded.)</li> <li>13. <b>Maximum inactive traffic power</b> is a floating point number (in dB or dBm depending on the measurement type) of the maximum average power of the inactive traffic channels. The slot timing is determined by Perch. In the MS mode, the value returned is -999. (SCH is excluded.)</li> </ol>

n	Results Returned
<p>n=1 (or not specified) W-CDMA mode (continued)</p>	<p>14. <b>Average inactive traffic power</b> is a floating point number (in dB or dBm depending on the measurement type) of the average power of the inactive traffic channels. In the MS mode, the value returned is -999. (SCH is excluded.)</p> <p>15. <b>Number of active channel</b> In the MS mode, the value returned is -999.</p> <p>16. <b>P-SCH</b> is a floating point number (in dBm) of the primary synchronization channel power. In the MS mode, the value returned is -999.</p> <p>17. <b>S-SCH</b> is a floating point number (in dBm) of the secondary synchronization channel power. In the MS mode, the value returned is -999.</p> <p>18. <b>DPCCH Power</b> is a floating point number (in dB or dBm depending on the measurement type) of the average power of dedicated physical control channel (DPCCH). In the BS mode, the value returned is -999.</p> <p>19. <b>DPCCH Beta Nominal</b> is a floating point number of the nominal beta value of DPCCH Beta factor. In the BS mode, the value returned is -999.</p> <p>20. <b>DPCCH Beta Measured</b> is a floating point number of the measured value of the DPCCH Beta factor. In the BS mode, the value returned is -999.</p> <p>21. <b>DPDCH Beta Nominal</b> is a floating point number of the nominal beta value of the dedicated physical data channel (DPDCH) Beta factor. In the BS mode, the value returned is -999.</p> <p>22. <b>DPDCH Beta 1 Measured</b> is a floating point number of the measured value of the DPDCH (C1) Beta factor. In the BS mode, the value returned is -999.</p> <p>23. <b>DPDCH Beta 2 Measured</b> is a floating point number of the measured value of the DPDCH (C2) Beta factor. In the BS mode, the value returned is -999.</p> <p>24. <b>DPDCH Beta 3 Measured</b> is a floating point number of the measured value of the DPDCH (C3) Beta factor. In the BS mode, the value returned is -999.</p> <p>25. <b>DPDCH Beta 4 Measured</b> is a floating point number of the measured value of the DPDCH (C4) Beta factor. In the BS mode, the value returned is -999.</p> <p>26. <b>DPDCH Beta 5 Measured</b> is a floating point number of the measured value of the DPDCH (C5) Beta factor. In the BS mode, the value returned is -999.</p> <p>27. <b>DPDCH Beta 6 Measured</b> is a floating point number of the measured value of the DPDCH (C6) Beta factor. In the BS mode, the value returned is -999.</p> <p>28. <b>I channel average active power</b> is a floating point number (in dB or dBm depending on the measurement type) of the average power of the active I channels. In the BS mode, the value returned is -999.</p>

<b>n</b>	<b>Results Returned</b>
n=1 (or not specified) W-CDMA mode (continued)	<p>29. <b>I channel maximum inactive power</b> is a floating point number (in dB or dBm depending on the measurement type) of the maximum average power of the inactive I channels. In the BS mode, the value returned is -999.</p> <p>30. <b>Q channel average active power</b> is a floating point number (in dB or dBm depending on the measurement type) of the average power of the active Q channels. In the BS mode, the value returned is -999.</p> <p>31. <b>Q channel maximum inactive power</b> is a floating point number (in dB or dBm depending on the measurement type) of the maximum average power of the inactive Q channels. In the BS mode, the value returned is -999.</p>

n	Results Returned
<p>n=1 (or not specified)</p> <p>1xEV-DO mode</p>	<p>Returns the following 11 comma-delimited scalar results, in the following order:</p> <ol style="list-style-type: none"> <li>1. <b>Total power</b> is a floating point number (in dBm) of the total RF power over the measurement interval.  NOTE: The following power results are computed by the CDP measurement. The unit used in the computation, either dB or dBm, is determined by the setting of the <b>CALCulate:CDPower:TYPE</b> command. When the selection is <b>ABSolute</b>, the unit used is dBm. When the selection is <b>RELative</b>, the unit used is dB relative to Total Power (above).</li> <li>2. <b>Total active power</b> is a floating point number (in dB or dBm depending on the measurement type) of the sum of the active powers (–.999.0 when no active channel is detected).</li> <li>3. <b>Maximum active power</b> is a floating point number (in dB or dBm depending on the measurement type) of the maximum average power of the active code. If no active channel is detected in Data mode, the value returned is –999. In Pilot and MAC modes, the value returned is –999.</li> <li>4. <b>Average active power</b> is a floating point number (in dB or dBm depending on the measurement type) of the average power of all the active traffic channels.. If no active channel is detected in Data mode, the value returned is –999. In Pilot and MAC modes, the value returned is –999.</li> <li>5. <b>Maximum inactive power</b> is a floating point number (in dB or dBm depending on the measurement type) of the maximum average power of the inactive traffic channels. In Pilot and MAC modes, the value returned is –999.</li> <li>6. <b>Average inactive power</b> is a floating point number (in dB or dBm depending on the measurement type) of the average power of the inactive traffic channels. In Pilot and MAC modes, the value returned is –999.</li> <li>7. <b>Number of active channels</b> In Pilot and MAC modes, the value returned is –999.</li> <li>8. <b>I channel average active power</b> is a floating point number (in dB or dBm depending on the measurement type) of the average power of the active I channels. In Data mode, the value returned is –999. In Pilot and MAC modes, if no active channel is detected, the value returned is –999.</li> <li>9. <b>I channel maximum inactive power</b> is a floating point number (in dB or dBm depending on the measurement type) of the maximum average power of the inactive I channels. In Data mode, the value returned is –999. In Pilot and MAC modes, if no active channel is detected, the value returned is –999.</li> <li>10. <b>Q channel average active power</b> is a floating point number (in dB or dBm depending on the measurement type) of the average power of the active Q channels. In Data mode, the value returned is –999. In Pilot and MAC modes, if no active channel is detected, the value returned is –999.</li> </ol>

n	Results Returned
n=1 (or not specified)  1xEV-DO mode (continued)	Returns the following 11 comma-delimited scalar results, in the following order:  <b>11. Q channel maximum inactive power</b> is a floating point number (in dB or dBm depending on the measurement type) of the maximum average power of the inactive Q channels. In Data mode, the value returned is -999. In Pilot and MAC modes, if no active channel is detected, the value returned is -999.
2  cdmaOne mode	Returns floating point numbers that are the trace data of the code domain <i>power</i> trace for all 64 Walsh codes. This series of 64 numbers represent the relative power levels (in dB) of all 64 walsh codes, with respect to the carrier power.
2  cdma2000, or 1xEV-DO mode	Returns a series of floating point numbers (in dB or dBm depending on the measurement type) that represents all the code domain powers.  With a device of BTS, there are 64 or 128 numbers depending on CALCulate:CDPower:WCODe:BASE. If the active channel occupies more than the max spreading factor (64 or 128 Walsh Code length depending on CALCulate:CDPower:WCODe:BASE) the power is duplicated (CALCulate:CDPower:WCODe:BASE / active Walsh code length) times.  1st number = 1st code power over the slot 2nd number = 2nd code power over the slot ... Nth number = Nth code power over the slot  With a device of MS, there are 256 I/Q pairs. If the active channel occupies more than the max spreading factor (C8) the power is duplicated (active Cx / C8) times.  1st number = 1st in-phase code power over the slot 2nd number = 1st quad-phase code power over the slot ... (2×N-1)th number = Nth in-phase code power over the slot (2×N)th number = Nth quad-phase code power over a slot  N = the number of codes detected. The total number of codes varies because of the different symbol rates of each code.



n	Results Returned
2 W-CDMA.mode	<p>Returns a series of floating point numbers (in dB or dBm depending on the measurement type) that represents all the code domain powers.</p> <p>With a device of BTS, there are 512 numbers. If the active channel occupies more than the max spreading factor (7.5 ksp/s) the power is duplicated (active symbol rate/7.5 ksp/s) times.</p> <p>1st number = 1st code power over the slot            2nd number = 2nd code power over the slot            ...            Nth number = Nth code power over the slot</p> <p>With a device of MS, there are 256 I/Q pairs. If the active channel occupies more than the max spreading factor (15 ksp/s) the power is duplicated (active symbol rate / 15 ksp/s) times.</p> <p>1st number = 1st in-phase code power over the slot            2nd number = 1st quad-phase code power over the slot            ...            (2×N-1)th number = Nth in-phase code power over the slot            (2×N)th number = Nth quad-phase code power over a slot</p> <p>N = the number of codes detected. The total number of codes varies because of the different symbol rates of each code.</p>
3 cdmaOne mode	<p>Returns floating point numbers that are the trace data of the code domain <i>timing</i> trace for all 64 Walsh codes. This series of 64 numbers represent the relative timing estimations (in seconds) of the codes, relative to the pilot channel. Typical values are on the order of 1 ns.</p>

n	Results Returned
3 cdma2000, or 1xEV-DO mode	<p>Returns a series of floating point numbers (in symbol rate) that represent all code domain symbol rates.</p> <p>With a device of BTS, there are 64 or 128 numbers depending on CALCulate:CDPower:WCODe:BASE. If the active channel occupies more than the max spreading factor (64 or 128 Walsh code length depending on CALCulate:CDPower:WCODe:BASE) the power is duplicated (CALCulate:CDPower:WCODe:BASE / active Walsh code length) times.</p> <p>1st number = 1st code symbol rate over the slot            2nd number = 2nd code symbol rate over the slot            ...            Nth number = Nth code symbol rate over the slot</p> <p>With a device of MS, there are 256 I/Q pairs. If the active channel occupies more than the max spreading factor (C8) the power is duplicated (active Cx / C8) times.</p> <p>1st number = 1st in-phase code symbol rate over the slot            2nd number = 1st quad-phase code symbol rate over the slot            ...            (2×N-1)th number = Nth in-phase code symbol rate over the slot            (2×N)th number = Nth quad-phase code symbol rate over the slot</p> <p>N = the number of codes detected. The total number of codes varies because of the different symbol rates of each code.</p>
3 W-CDMA mode	<p>Returns a series of floating point numbers (in symbol rate) that represent all code domain symbol rates.</p> <p>With a device of BTS, there are 512 numbers. If the active channel occupies more than the max spreading factor (7.5 ksps) the power is duplicated (active symbol rate/7.5 ksps) times.</p> <p>1st number = 1st code symbol rate over the slot            2nd number = 2nd code symbol rate over the slot            ...            Nth number = Nth code symbol rate over the slot</p> <p>With a device of MS, there are 256 I/Q pairs. If the active channel occupies more than the max spreading factor (15 ksps) the power is duplicated (active symbol rate/15 ksps) times.</p> <p>1st number = 1st in-phase code symbol rate over the slot            2nd number = 1st quad-phase code symbol rate over the slot            ...            (2×N-1)th number = Nth in-phase code symbol rate over the slot            (2×N)th number = Nth quad-phase code symbol rate over the slot</p> <p>N = the number of codes detected. The total number of codes varies because of the different symbol rates of each code.</p>

n	Results Returned
4 cdmaOne mode	Returns floating point numbers that are the trace data of the code domain <i>phase</i> trace for all 64 Walsh codes. This series of 64 numbers represent the relative phase estimations (in radians) of the codes, relative to the pilot channel. Typical values are on the order of 1 mrad.
4 cdma2000, W-CDMA, or 1xEV-DO mode	Returns a series of floating point numbers that show either active or inactive status for each of the code powers returned in n=2. (See above.) If a code is inactive, the value returned is 0.0, otherwise a value >0.0 is returned.  1st number = active or inactive flag of the 1st code ... Nth number = active or inactive flag of the Nth code  (where N= the number of codes identified)
5 cdma2000, or W-CDMA mode	Returns a series of floating point numbers (in percent) that represent each sample in the <i>EVM</i> trace. The first number is the symbol 0 decision point and there are X points per symbol. Therefore, the decision points are at 0, 1×X, 2×X, 3×X. . .  (where X = the number of points per chip)
5 1xEV-DO mode	Returns series of floating point numbers that alternately represent I and Q pairs of the <i>corrected measured</i> trace. The magnitude of each I and Q pair is normalized to 1.0. The first number is the in-phase (I) sample of symbol 0 decision point and the second is the quadrature-phase (Q) sample of symbol 0 decision point. As in the EVM, there are X points per symbol, so that:  1st number is I of the symbol 0 decision point 2nd number is Q of the symbol 0 decision point ... (2×X)+1 number is I of the symbol 1 decision point (2×X)+2 number is Q of the symbol 1 decision point ... (2×X)×N+1th number is I of the symbol N decision point (2×X)×N+2th number is Q of the symbol N decision point  where X = the number of points per symbol, and N = the number of symbols
6 cdma2000, or W-CDMA mode	Returns a series of floating point numbers (in percent) that represent each sample in the <i>magnitude error</i> trace. The first number is the symbol 0 decision point and there are X points per symbol. Therefore, the decision points are at 0, 1×X, 2×X, 3×X. . .  (where X = the number of points per chip)
6 1xEV-DO mode	Returns series of floating point numbers (in dBm) that represent the trace data of the chip power vs. time.

n	Results Returned
7 cdma2000, or W-CDMA mode	<p>Returns a series of floating point numbers (in degrees) that represent each sample in the <i>phase error</i> trace. The first number is the symbol 0 decision point and there are X points per symbol. Therefore, the decision points are at 0, 1×X, 2×X, 3×X. . .</p> <p>(where X = the number of points per chip)</p>
8 cdma2000, or W-CDMA mode	<p>Returns series of floating point numbers that alternately represent I and Q pairs of the <i>corrected measured</i> trace. The magnitude of each I and Q pair is normalized to 1.0. The first number is the in-phase (I) sample of symbol 0 decision point and the second is the quadrature-phase (Q) sample of symbol 0 decision point. As in the EVM, there are X points per symbol, so that:</p> <p>1st number is I of the symbol 0 decision point        2nd number is Q of the symbol 0 decision point        . . .        (2×X)+1 number is I of the symbol 1 decision point        (2×X)+2 number is Q of the symbol 1 decision point        . . .        (2×X)×N+1th number is I of the symbol N decision point        (2×X)×N+2th number is Q of the symbol N decision point</p> <p>where X = the number of points per symbol, and        N = the number of symbols</p>
9 cdma2000, or W-CDMA mode	<p>Returns series of floating point numbers (in dBm) that represent the trace data of the symbol power vs. time.</p>
10 cdma2000, or W-CDMA mode	<p>Returns series of floating point numbers (in dBm) that represent the trace data of the chip power vs. time.</p>
11 cdma2000, or W-CDMA mode	<p>Returns series of floating point numbers (0.0 or 1.0) of symbol values for the selected code with the entire capture length.</p>

## Channel Power Measurement

This measures the total rms power in a specified integration bandwidth. You must be in the cdmaOne, cdma2000, or W-CDMA, or 1xEV-DO mode to use these commands. Use INSTRUMENT:SELEct to set the mode.

The general functionality of CONFigure, FETCh, MEASure, and READ are described at the beginning of this section. See the SENSE:CHPower commands for more measurement related commands.

```
:CONFigure:CHPower
:INITiate:CHPower
:FETCh:CHPower [n] ?
:READ:CHPower [n] ?
:MEASure:CHPower [n] ?
```

Front Panel

Access: **Measure, Channel Power**

After the measurement is selected, press **Restore Meas Defaults** to restore factory defaults.

### Measurement Results Available

n	Results Returned
0	Returns unprocessed I/Q trace data, as a series of trace point values, in volts. The I values are listed first in each pair, using the 0 through even-indexed values. The Q values are the odd-indexed values.
n=1 (or not specified)	Returns 2 scalar results: <ol style="list-style-type: none"> <li><b>Channel Power</b> is a floating point number representing the total channel power in the specified integration bandwidth.</li> <li><b>Power Spectral Density</b> is the power (in dBm/Hz) in the specified integration bandwidth.</li> </ol>
2	Returns floating point numbers that are the captured trace data of the power (in dBm/resolution BW) of the signal. The frequency span of the captured trace data is specified by the <b>Span</b> key.

## QPSK Error Vector Magnitude Measurement

This measures the QPSK error vector magnitude of each symbol. You must be in the cdma2000, W-CDMA, or 1xEV-DO mode to use these commands. Use INSTRument:SElect to set the mode.

The general functionality of CONFigure, FETCh, MEASure, and READ are described at the beginning of this section. See the SENSE:EVMQpsk commands for more measurement related commands.

```
:CONFigure:EVMQpsk
:INITiate:EVMQpsk
:FETCh:EVMQpsk [n] ?
:READ:EVMQpsk [n] ?
:MEASure:EVMQpsk [n] ?
```

History: Version A.03.00 or later

Front Panel

Access: **Measure, QPSK EVM**

After the measurement is selected, press **Restore Meas Defaults** to restore factory defaults.

### Measurement Results Available

n	Results Returned
0	Returns unprocessed I/Q trace data, as a data array of trace point values, in volts.

n	Results Returned
1 (default)	<p>Returns 11 scalar results, in the following order.</p> <ol style="list-style-type: none"> <li>1. <b>RMS EVM</b> is a floating point number (in percent) of EVM over the entire measurement area.</li> <li>2. <b>RMS EVM maximum</b> is the maximum RMS EVM over the averaged counts</li> <li>3. <b>Peak EVM</b> is a floating point number (in percent) of peak EVM in the measurement area.</li> <li>4. <b>Peak EVM maximum</b> is the maximum peak EVM over the averaged counts.</li> <li>5. <b>Magnitude error</b> is a floating point number (in percent) of average magnitude error over the entire measurement area.</li> <li>6. <b>Magnitude error maximum</b> is the maximum magnitude error over the averaged counts.</li> <li>7. <b>Phase error</b> is a floating point number (in degree) of average phase error over the entire measurement area.</li> <li>8. <b>Phase error maximum</b> is the maximum phase error over the averaged counts.</li> <li>9. <b>Frequency error</b> is a floating point number (in Hz) of the frequency error in the measured signal.</li> <li>10. <b>Frequency error maximum</b> is the maximum frequency error over the averaged counts.</li> <li>11. <b>I/Q origin offset</b> is a floating point number (in dB) of the I and Q error (magnitude squared) offset from the origin.</li> </ol>
2	<p>EVM trace – returns series of floating point numbers (in percent) that represent each sample in the EVM trace. The first number is the symbol 0 decision point. There are <math>X</math> points per symbol (<math>X = \text{points/chip}</math>). Therefore, the decision points are at <math>0, 1 \times X, 2 \times X, 3 \times X \dots</math></p>
3	<p>Magnitude error trace – returns series of floating point numbers (in percent) that represent each sample in the magnitude error trace. The first number is the symbol 0 decision point. There are <math>X</math> points per symbol (<math>X = \text{points/chip}</math>). Therefore, the decision points are at <math>0, 1 \times X, 2 \times X, 3 \times X \dots</math></p>
4	<p>Phase error trace – returns series of floating point numbers (in degree) that represent each sample in the phase error trace. There are <math>X</math> points per symbol (<math>X = \text{points/ chip}</math>). Therefore, the decision points are at <math>0, 1 \times X, 2 \times X, 3 \times X \dots</math></p>

n	Results Returned
5	<p>Corrected measured trace – returns series of floating point numbers that alternately represent I and Q pairs of the corrected measured trace. The magnitude of each I and Q pair are normalized to 1.0. The first number is the in-phase (I) sample of symbol 0 decision point and the second is the quadrature-phase (Q) sample of symbol 0 decision point. There are <math>X</math> points per symbol (<math>X = \text{points/chip}</math>), so the series of numbers is:</p> <p>1st number = I of the symbol 0 decision point            2nd number = Q of the symbol 0 decision point</p> <p style="text-align: center;">. . .</p> <p><math>(2 \times X) + 1</math>, number = I of the symbol 1 decision point  <math>(2 \times X) + 2</math>, number = Q of the symbol 1 decision point</p> <p style="text-align: center;">. . .</p> <p><math>(2 \times X) \times N\text{th} + 1</math> number = I of the symbol N decision point  <math>(2 \times X) \times N\text{th} + 2</math> number = Q of the symbol N decision point</p>



## Intermodulation Measurement

This measures the third order and fifth order intermodulation products caused by the wanted signal and the interfering signal. You must be in cdma2000, W-CDMA, or 1xEV-DO mode to use these commands. Use INSTRument:SElect to set the mode.

The general functionality of CONFigure, FETCh, MEASure, and READ are described at the beginning of this section. See the SENSE:IM commands for more measurement related commands.

```
:CONFigure:IM
:INITiate:IM
:FETCh:IM[n]?
:READ:IM[n]?
:MEASure:IM[n]?
```

Front Panel

Access: **Measure, Intermod**

After the measurement is selected, press **Restore Meas Defaults** to restore factory defaults.

### Measurement Results Available

<b>n</b>	<b>Results Returned</b>
0	Returns unprocessed I/Q trace data that acquired in the last acquisition when multiple acquisition is performed, as a data array of trace point values, in volts.

n	Results Returned
1 (default)	<p>Returns 23 scalar results in the following order.</p> <ol style="list-style-type: none"> <li>1. Absolute power of the reference (dBm)</li> <li>2. Base lower frequency (Hz)</li> <li>3. Base lower absolute power (dBm)</li> <li>4. Base lower relative power to the reference (dBc)</li> <li>5. Base upper frequency (Hz)</li> <li>6. Base upper absolute power (dBm)</li> <li>7. Base upper relative power to the reference (dBc)</li> <li>8. Third order lower frequency (Hz)</li> <li>9. Third order lower absolute power (dBm)</li> <li>10. Third order lower relative power to the reference power (dBc)</li> <li>11. Third order lower power spectrum density (dBm/Hz)</li> <li>12. Third order upper frequency (Hz)</li> <li>13. Third order upper absolute power (dBm)</li> <li>14. Third order upper relative power to the reference power (dBc)</li> <li>15. Third order upper power spectrum density (dBm/Hz)</li> <li>16. Fifth order lower frequency (Hz)</li> <li>17. Fifth order lower absolute power (dBm)</li> <li>18. Fifth order lower relative power to the reference power (dBc)</li> <li>19. Fifth order lower power spectrum density (dBm/Hz)</li> <li>20. Fifth order upper frequency (Hz)</li> <li>21. Fifth order upper absolute power (dBm)</li> <li>22. Fifth order upper relative power to the reference power (dBc)</li> <li>23. Fifth order upper power spectrum density (dBm/Hz)</li> </ol> <p>If the results are not available, -999.0 is returned for the power results and 0.0 for the frequency results.</p>
2 cdma2000, 1xEV-DO mode	<p>Returns a series of floating point numbers that represent the frequency-domain spectrum trace for the entire frequency range being measured.</p> <p>In the default settings (SENSE:IM:FREQUENCY:SPAN 20 MHz; SENSE:IM:BANDWIDTH   BWIDTH[:RESOLUTION] 140 kHz), there are 345 numbers.</p>
2 W-CDMA mode	<p>Returns a series of floating point numbers that represent the frequency-domain spectrum trace for the entire frequency range being measured.</p> <p>In the default settings (SENSE:IM:FREQUENCY:SPAN 50 MHz; SENSE:IM:BANDWIDTH   BWIDTH[:RESOLUTION] 140 kHz), there are 872 numbers.</p>

<b>n</b>	<b>Results Returned</b>
3	<p>Returns 2 scalar values of the measured mode determined by the Auto algorithm.</p> <ol style="list-style-type: none"><li>1. Measurement Mode:<ol style="list-style-type: none"><li>1: Two-tone</li><li>2: Transmit IM</li><li>3: Auto (Two-tone)</li><li>4: Auto (Transmit IM)</li><li>5: Unknown</li></ol></li><li>2. Reference:<ol style="list-style-type: none"><li>1: Lower</li><li>2: Upper</li><li>3: Average</li><li>4: Auto (Lower)</li><li>5: Auto (Upper)</li></ol></li></ol>

## Occupied Bandwidth Measurement

This measures the bandwidth of the carrier signal in the occupied part of the channel. You must be in the PDC, cdma2000, W-CDMA, or 1xEV-DO mode to use these commands. Use INSTRument:SElect to set the mode.

The general functionality of CONFigure, FETCh, MEASure, and READ are described at the beginning of this section. See the SENSE:OBW commands for more measurement related commands.

```
:CONFigure:OBW
:INITiate:OBW
:FETCh:OBW [n] ?
:READ:OBW [n] ?
:MEASure:OBW [n] ?
```

Front Panel

Access: **Measure, Occupied BW**

After the measurement is selected, press **Restore Meas Defaults** to restore factory defaults.

### Measurement results available

n	Results Returned
0	Returns unprocessed I/Q trace data, as a data array of trace point values, in volts.
1 (default) PDC, cdma2000, W-CDMA mode	Returns 2 scalar results, in the following order: <ol style="list-style-type: none"> <li>1. Occupied bandwidth - Hz</li> <li>2. Absolute Carrier Power - dBm</li> </ol>
1 (default) 1xEV-DO mode	Returns 2 scalar results, in the following order: <ol style="list-style-type: none"> <li>1. Occupied bandwidth - Hz</li> <li>2. Absolute Carrier Power - dBm</li> <li>3. Span - Hz</li> <li>4. Spectrum Trace Points - points</li> <li>5. Res BW - Hz</li> </ol>
2 PDC, cdma2000, W-CDMA, 1xEV-DO mode	Returns the frequency-domain spectrum trace (data array) for the entire frequency range being measured.

## Power Statistics CCDF Measurement

This is a statistical power measurement of the complementary cumulative distribution function (CCDF). You must be in the cdma2000, W-CDMA, or 1xEV-DO mode to use these commands. Use INSTRument:SElect to set the mode.

The general functionality of CONFigure, FETCh, MEASure, and READ are described at the beginning of this section. See the SENSE:PStat commands for more measurement related commands.

**:CONFigure:PStatistic**

**:INITiate:PStatistic**

**:FETCh:PStatistic [n] ?**

**:READ:PStatatistic [n] ?**

**:MEASure:PStatatistic [n] ?**

History: Version A.03.00 or later, added in Basic A.04.00

Front Panel

Access: **Measure, Power Stat CCDF**

After the measurement is selected, press **Restore Meas Defaults** to restore factory defaults.

### Measurement Results Available

<b>n</b>	<b>Results Returned</b>
0	Returns unprocessed I/Q trace data, as a series of trace point values, in volts. The I values are listed first in each pair, using the 0 through even-indexed values. The Q values are the odd-indexed values,
n=1 (or not specified)	Returns 10 scalar results: <ol style="list-style-type: none"> <li>1. Average input power (in dBm)</li> <li>2. Probability at the average input power level (in %)</li> <li>3. Power level that has 10% of the power</li> <li>4. Power level that has 1% of the power</li> <li>5. Power level that has 0.1% of the power</li> <li>6. Power level that has 0.01% of the power</li> <li>7. Power level that has 0.001% of the power</li> <li>8. Power level that has 0.0001% of the power</li> <li>9. Peak power (in dB)</li> <li>10. Count</li> </ol>

n	Results Returned
2	<p>Returns a series of 5001 floating point numbers (in percent) that represent the current measured power stat trace. This is the probability at particular power levels (average power), in the following order:</p> <ol style="list-style-type: none"> <li>1. Probability at 0.0 dB power</li> <li>2. Probability at 0.01 dB power</li> <li>3. Probability at 0.02 dB power</li> </ol> <p style="text-align: center;">. . .</p> <ol style="list-style-type: none"> <li>1. Probability at 49.9 dB power</li> <li>2. Probability at 50.0 dB power</li> </ol>
3	<p>Returns a series of 5001 floating point numbers (in percent) that represent the Gaussian trace. This is the probability at particular power levels (average power), in the following order:</p> <ol style="list-style-type: none"> <li>1. Probability at 0.0 dB power</li> <li>2. Probability at 0.01 dB power</li> <li>3. Probability at 0.02 dB power</li> </ol> <p style="text-align: center;">. . .</p> <ol style="list-style-type: none"> <li>1. Probability at 49.9 dB power</li> <li>2. Probability at 50.0 dB power</li> </ol>
4	<p>Returns a series of 5001 floating point numbers (in percent) that represent the user-definable reference trace. This is the probability at particular power levels (average power), in the following order:</p> <ol style="list-style-type: none"> <li>1. Probability at 0.0 dB power</li> <li>2. Probability at 0.01 dB power</li> <li>3. Probability at 0.02 dB power</li> </ol> <p style="text-align: center;">. . .</p> <ol style="list-style-type: none"> <li>1. Probability at 49.9 dB power</li> <li>2. Probability at 50.0 dB power</li> </ol>

## Modulation Accuracy (Rho) Measurement

This measures the modulation accuracy of the transmitter by checking the magnitude and phase error and the EVM (error vector magnitude). You must be in the cdmaOne, cdma2000, W-CDMA, or 1xEV-DO mode to use these commands. Use INSTRument:SElect to set the mode.

For 1xEV-DO: these commands will measure modulation accuracy on network access equipment (base transmitter stations). Use MEAS:TRHO to measure terminal transmitter modulation accuracy, after selecting mobile stations using SENSE:RADio:DEvIce MS.

The general functionality of CONFIGure, FETCh, MEASure, and READ are described at the beginning of this section. See the SENSE:RHO commands for more measurement related commands.

```
:CONFigure:RHO
:INITiate:RHO
:FETCh:RHO [n] ?
:READ:RHO [n] ?
:MEASure:RHO [n] ?
```

Front Panel

Access: **Measure, Mod Accuracy (Rho)** for cdmaOne

**Measure, Mod Accuracy (Composite Rho)** for cdma2000, 1xEV-DO, or W-CDMA (3GPP)

After the measurement is selected, press **Restore Meas Defaults** to restore factory defaults.

### Measurement Results Available

n	Results Returned
0 cdmaOne mode	Returns unprocessed I/Q trace data, as a series of trace point values. The I values are listed first in each pair, using the 0 through even-indexed values. The Q values are the odd-indexed values.  The standard sample rate is 7.5 MHz and the trace length is determined by the current measurement interval.
0 cdma2000 or W-CDMA mode	Returns unprocessed I/Q trace data, as a series of trace point values. The I values are listed first in each pair, using the 0 through even-indexed values. The Q values are the odd-indexed values.

n	Results Returned
n=1 (or not specified) cdmaOne mode	<p>Returns 7 floating point numbers, in the following order:</p> <ol style="list-style-type: none"> <li>1. <b>Rho</b> (no units) represents the correlation of the measured power compared to the ideal pilot channel. The calculation is performed after the complementary filter, so it is IS95 compliant. It is performed at the decision points in the pilot waveform. If averaging is on, this is the average of the individual rms measurements.</li> <li>2. <b>Time offset</b> (with units of seconds) is the time delay of the even second clock with respect to the start of the short code PN sequences, at offsets from the 15 zeros in the characteristic phase of the sequence.</li> <li>3. <b>Frequency error</b> of the measured signal, with units of Hz. This is based on the linear best fit of the uncorrected measured phase.</li> <li>4. <b>Carrier feedthrough</b> has units of dB and is the dc error offset of I and Q, from the origin.</li> <li>5. <b>EVM</b> has units of percent. The calculation is based on the composite of the phase error and magnitude error, between the measured signal and the ideal pilot channel. It is performed after the complementary filter which removes the inter-symbol interference in the modulated data. If averaging is on, this is the average of the individual rms measurements.</li> <li>6. <b>Magnitude error</b> (with units of percent) is the rms error between the measured (compensated) magnitude and the ideal magnitude. This is performed after the complementary filter which removes the inter-symbol interference in the modulated data. If averaging is on, this is the average of the individual rms measurements.</li> <li>7. <b>Phase error</b> (with units in percent) is the rms phase error between the measured phase and the ideal phase. The calculation is performed after the complementary filter which removes the inter-symbol interference in the modulated data. If averaging is on, this is the average of the individual rms measurements.</li> </ol>



n	Results Returned
<p>n=1 (or not specified) cdma2000</p>	<p>Returns 11 scalar results, in the following order.</p> <ol style="list-style-type: none"> <li>1. <b>RMS EVM</b> is a floating point number (in percent) of EVM over the entire measurement area</li> <li>2. <b>Peak EVM</b> is a floating point number (in percent) of peak EVM in the measurement area</li> <li>3. <b>Magnitude error</b> is a floating point number (in percent) of average magnitude error over the entire measurement area</li> <li>4. <b>Phase error</b> is a floating point number (in degree) of average phase error over the entire measurement area</li> <li>5. <b>I/Q origin offset</b> is a floating point number (in dB) of the I and Q error (magnitude squared) offset from the origin</li> <li>6. <b>Frequency error</b> is a floating point number (in Hz) of the frequency error in the measured signal</li> <li>7. <b>Rho</b> is a floating point number of Rho</li> <li>8. <b>Peak code domain error</b> is a floating point number (in dB) of the Peak Code Domain Error relative to the mean power</li> <li>9. <b>Peak code domain error channel number</b> is the channel number in which the peak code domain error is detected at the max spreading factor.</li> </ol> <p>NOTE: For MS measurements of Q channel numbers, subtract 32 from the number returned by SCPI query to obtain the actual channel number. For example, if the front panel displayed result is "W32(15):Q", then the SCPI query result will be "47". As <math>47 - 32 = 15</math>, 15 is the actual Peak CDE channel number result.</p> <p>For I channel MS measurements, as well as both I and Q channel BTS measurements, the returned number is the actual Peak CDE channel number.</p> <ol style="list-style-type: none"> <li>10. <b>Number of active channels.</b></li> <li>11. <b>Time offset</b> is a floating point number (in second) PN offset from the trigger point.</li> </ol>

n	Results Returned
<p>n=1 (or not specified) W-CDMA mode</p>	<p>Returns following 13 scalar results, in the following order.</p> <ol style="list-style-type: none"> <li>1. <b>RMS EVM</b> is a floating point number (in percent) of EVM over the entire measurement area</li> <li>2. <b>Peak EVM error</b> is a floating point number (in percent) of peak EVM in the measurement area</li> <li>3. <b>Magnitude error</b> is a floating point number (in percent) of average magnitude error over the entire measurement area</li> <li>4. <b>Phase error</b> is a floating point number (in degree) of average phase error over the entire measurement area</li> <li>5. <b>I/Q origin offset</b> is a floating point number (in dB) of the I and Q error (magnitude squared) offset from the origin</li> <li>6. <b>Frequency error</b> is a floating point number (in Hz) of the frequency error in the measured signal</li> <li>7. <b>Rho</b> is a floating point number of Rho</li> <li>8. <b>Peak Code Domain Error</b> is a floating point number (in dB) of the Peak Code Domain Error relative to the mean power</li> <li>9. <b>Peak Code Domain Error Channel Number</b> is the channel number in which the peak code domain error is detected at the max spreading factor.</li> <li>10. <b>Number of active channels.</b></li> <li>11. <b>Time offset</b> is a floating point number (in chip) of the pilot phase timing from the acquisition trigger point.</li> <li>12. <b>CPICH power over a slot</b> is a floating point number in dB of CPICH power over a measurement slot. In the MS mode the value returned is -999.</li> <li>13. <b>Average total power over a slot</b> is a floating point number in dB of total RF power over a measurement slot.</li> </ol>
<p>n=1 (or not specified) 1xEV-DO mode For base stations: SENS:RAD:DEV BTS For meas type: CALC:RHO:TYPE DATA   MAC   PILot   PREamble</p>	<p>Returns up to the following 31 comma-separated scalar results, in the following order:</p> <p>Returns ONLY the following 9 comma-separated scalar results, in the following order, for base transmitter station measurements when the type is <i>NOT</i> set to ALL:</p> <ol style="list-style-type: none"> <li>1. <b>RMS EVM</b> – a floating point number (in percent) of EVM over the entire measurement area.</li> <li>2. <b>Peak EVM error</b> – a floating point number (in percent) of peak EVM in the measurement area.</li> <li>3. <b>Magnitude error</b> – a floating point number (in percent) of average magnitude error over the entire measurement area.</li> <li>4. <b>Phase error</b> – a floating point number (in degree) of average phase error over the entire measurement area.</li> <li>5. <b>I/Q Origin Offset</b> – a floating point number (in dB) of the I and Q error (magnitude squared) offset from the origin.</li> <li>6. <b>Frequency error</b> – a floating point number (in Hz) of the frequency error in the measured signal.</li> <li>7. <b>Rho</b> – a floating point number of Rho.</li> <li>8. <b>Number of active channels.</b></li> <li>9. <b>Time offset</b> is the time from the trigger to the PN offset – a floating point number (in micro seconds) of PN offset from the trigger point.</li> </ol>

n	Results Returned
<p>n=1 (or not specified)</p> <p>1xEV-DO mode</p> <p>For base stations: SENS:RAD:DEV BTS</p> <p>For meas type ALL: CALC:RHO:TYPE ALL</p>	<p>Returns the following 17 scalar results for base transmitter station measurements when the type is set to ALL.</p> <p>Rho Overall-1 and Rho Overall-2 specified in 3GPP2 TSG-C4.1 Recommended Minimum Performance Standard for cdma2000 High Rate Data Packet Access Network, 11.4.2 Waveform Quality Measurement section.</p> <ol style="list-style-type: none"> <li>10. <b>RMS EVM</b> (Overall-1) – a floating point number (in percent) of EVM over the entire measurement area.</li> <li>11. <b>Peak EVM error</b> (Overall-1) – a floating point number (in percent) of peak EVM in the measurement area.</li> <li>12. <b>Magnitude error</b> (Overall-1) – a floating point number (in percent) of average magnitude error over the entire measurement area.</li> <li>13. <b>Phase error</b> (Overall-1) – a floating point number (in degree) of average phase error over the entire measurement area.</li> <li>14. <b>I/Q Origin Offset</b> (Overall-1) – a floating point number (in dB) of the I and Q error (magnitude squared) offset from the origin.</li> <li>15. <b>Frequency error</b> (Overall-1) – a floating point number (in Hz) of the frequency error in the measured signal.</li> <li>16. <b>Rho</b> (Overall-1) – a floating point number of Rho.</li> <li>17. <b>RMS EVM</b> (Overall-2) – a floating point number (in percent) of EVM over the entire measurement area.</li> <li>18. <b>Peak EVM error</b> (Overall-2) – a floating point number (in percent) of peak EVM in the measurement area.</li> <li>19. <b>Magnitude error</b> (Overall-2) – a floating point number (in percent) of average magnitude error over the entire measurement area.</li> <li>20. <b>Phase error</b> (Overall-2) – a floating point number (in degree) of average phase error over the entire measurement area.</li> <li>21. <b>I/Q Origin Offset</b> (Overall-2) – a floating point number (in dB) of the I and Q error (magnitude squared) offset from the origin.</li> <li>22. <b>Frequency error</b> (Overall-2) – a floating point number (in Hz) of the frequency error in the measured signal.</li> <li>23. <b>Rho</b> (Overall-2) – a floating point number of Rho.</li> <li>24. <b>Number of active channels in Pilot</b></li> <li>25. <b>Number of active channels in Mac</b></li> <li>26. <b>Number of active channels in Data</b></li> <li>27. <b>Preamble Length</b></li> <li>28. <b>MAC Index</b></li> <li>29. <b>Number of Max MAC Inactive channel Power – a floating point number (in dB) of Maximum MAC Inactive Channel Power channels in Data</b></li> <li>30. <b>Max Data Active Channel Power – a floating point number (in dB) of Maximum Data Active Channel Power</b></li> <li>31. <b>Min Data Active Channel Power – a floating point number (in dB) of Minimum Data Active Channel Power</b></li> </ol>

n	Results Returned
2 cdmaOne mode	EVM trace – returns error vector magnitude (EVM) data, as trace point values in percent. The first value is the chip 0 decision point. The trace is interpolated for the currently selected points/chips displayed on the front panel. The number of trace points depends on the current measurement interval setting.
2 cdma2000 or W-CDMA mode	EVM trace – returns series of floating point numbers (in percent) that represent each sample in the EVM trace. The first number is the symbol 0 decision point. There are $X$ points per symbol ( $X = \text{points/chip}$ ). Therefore, the decision points are at $0, 1 \times X, 2 \times X, 3 \times X \dots$
2 1xEV-DO mode	Returns series of floating point numbers (in percent) that represent each sample in the EVM trace. The first number is the symbol 0 decision point and there are $X$ points per symbol. Therefore, the decision points are at $0, 1xX, 2xX, 3xX\dots$  ( $X = \text{the number of points per chip}$ )  This traces is available when the Measurement Channel Type Selection is Pilot, MAC or Data (CALCulate:RHO:TYPE = PILot   MAC   DATA) In all cases, returns one full slot data points, but only portion of EVM computation is performed are valid. All other portion is 0.0
3 cdmaOne mode	Magnitude error trace – returns magnitude error data, as trace point values, in percent. The first value is the chip 0 decision point. The trace is interpolated for the currently selected points/chips displayed on the front panel. The number of trace points depends on the current measurement interval setting.
3 cdma2000, W-CDMA, or 1xEV-DO mode	Magnitude error trace – returns series of floating point numbers (in percent) that represent each sample in the magnitude error trace. The first number is the symbol 0 decision point. There are $X$ points per symbol ( $X = \text{points/chip}$ ). Therefore, the decision points are at $0, 1 \times X, 2 \times X, 3 \times X \dots$  For 1xEV-DO: this traces is available when the Measurement Channel Type Selection is Pilot, MAC or Data (CALCulate:RHO:TYPE = PILot   MAC   DATA) In all cases, returns one full slot data points, but only portion of EVM computation is performed are valid. All other portion is 0.0
4 cdmaOne mode	Phase error trace – returns phase error data, as trace point values, in degrees. The first value is the symbol 0 decision point. The trace is interpolated for the currently selected chips/symbol displayed on the front panel. The number of trace points depends on the current measurement interval setting.

n	Results Returned
4 cdma2000, W-CDMA, or 1xEV-DO mode	<p>Phase error trace – returns series of floating point numbers (in degrees) that represent each sample in the phase error trace. There are <math>X</math> points per symbol (<math>X = \text{points}/\text{chip}</math>). Therefore, the decision points are at <math>0, 1 \times X, 2 \times X, 3 \times X \dots</math></p> <p>For 1xEV-DO: this traces is available when the Measurement Channel Type Selection is Pilot, MAC or Data (CALCulate:RHO:TYPE = PILOt   MAC   DATA) In all cases, returns one full slot data points, but only portion of EVM computation is performed are valid. All other portion is 0.0</p>
5 cdmaOne mode	<p>Corrected measured data – returns a series of floating point numbers that alternately represent I and Q pairs of the corrected measured trace data. The magnitude of each I and Q pair are normalized to 1.0.</p> <p>The number of trace points depends on the current measurement interval setting.</p> <p>The numbers are sent in the following order:</p> <p style="padding-left: 40px;">In-phase (I) sample, of symbol 0 decision point Quadrature-phase (Q) sample, of symbol 0 decision point ... In-phase (I) sample, of symbol 1 decision point Quadrature-phase (Q) sample, of symbol 1 decision point ...</p> <p>The trace can be interpolated to 2,4, 8 points/chip selected with the display Points/Chip softkey. This will change the number of points between decision points in the trace, changing the number of I/Q pairs sent for each decision point.</p>
5 cdma2000, W-CDMA, 1xEV-DO mode	<p>Corrected measured trace – returns series of floating point numbers that alternately represent I and Q pairs of the corrected measured trace. The magnitude of each I and Q pair are normalized to 1.0. The first number is the in-phase (I) sample of symbol 0 decision point and the second is the quadrature-phase (Q) sample of symbol 0 decision point. There are <math>X</math> points per symbol (<math>X = \text{points}/\text{chip}</math>), so the series of numbers is:</p> <p style="padding-left: 40px;">1st number = I of the symbol 0 decision point 2nd number = Q of the symbol 0 decision point ... (<math>2 \times X + 1</math>), number = I of the symbol 1 decision point (<math>2 \times X + 2</math>), number = Q of the symbol 1 decision point ... (<math>2 \times X \times N + 1</math>) number = I of the symbol N decision point (<math>2 \times X \times N + 2</math>) number = Q of the symbol N decision point</p> <p>For 1xEV-DO: this traces is available when the Measurement Channel Type Selection is Pilot, MAC or Data (CALCulate:RHO:TYPE = PILOt   MAC   DATA) In all cases, returns one full slot data points, but only portion of EVM computation is performed are valid. All other portion is 0.0</p>

<b>n</b>	<b>Results Returned</b>
6 cdmaOne mode	<p>Reference IQ data – returns a series of floating point numbers that alternately represent I and Q pairs of the reference trace data.</p> <p>The number of trace points depends on the current measurement interval and points per chip settings.</p> <p>The numbers are sent in the following order:</p> <p style="padding-left: 40px;">In-phase (I) sample, of symbol 0 decision point            Quadrature-phase (Q) sample, of symbol 0 decision point            ...            In-phase (I) sample, of symbol 1 decision point            Quadrature-phase (Q) sample, of symbol 1 decision point            ...</p> <p>The trace can be interpolated to 2,4,8 points/chip selected with the display Points/Chip softkey.</p>
6 cdma2000 mode	<p>Returns 6 scalar values of the pass/fail (0=passed, or 1=failed) results determined by testing the EVM and peak EVM.</p> <ol style="list-style-type: none"> <li>1. Test result of EVM</li> <li>2. Test result of Peak EVM</li> <li>3. Test result of Rho</li> <li>4. Test result of Peak Code Domain Error</li> <li>5. Test result of Time Offset</li> <li>6. Test result of Phase Error</li> </ol>
6 1xEV-DO mode	<p>The same as n=2. (Overall-1)</p> <p>This trace is available when the Measurement Channel Type Selection is All            (CALCulate:RHO:TYPE = ALL)</p> <p>(Rho Overall-1 and Rho Overall-2 as specified in 3GPP2 TSG-C4.1 Recommended Minimum Performance Standard for cdma2000 High Rate Data Packet Access Network, 11.4.2 Waveform Quality Measurement section.)</p> <p>n=6, 7, 8, 9 are for Overall-1 data trace            n=10, 11, 12, 13 are for Overall-2 data trace</p> <p>In all cases, returns one full slot data points, but only portion of EVM computation is performed are valid. All other portion is 0.0</p>
6 W-CDMA mode	<p>Returns 6 comma-separated scalar values of the pass/fail (0.0 = passed, or 1.0 = failed) results determined by testing the EVM and peak EVM.</p> <ol style="list-style-type: none"> <li>1. Test result of EVM</li> <li>2. Test result of Peak EVM</li> <li>3. Test result of Rho</li> <li>4. Test result of Peak Code Domain Error</li> <li>5. Test result of Frequency Error</li> <li>6. Test result of CPICH power over a frame (If MS is selected, this always returns 0.0.)</li> </ol>

n	Results Returned
7 cdmaOne mode	<p>complementary filtered measured data – returns a series of floating point numbers that alternately represent I and Q pairs of the complementary filtered measured data. This is inverse filtered data of the inter-symbol interference in CDMA signals due to the digital transmission filters defined in the standard as well as the base station phase equalization filter.</p> <p>The number of trace points depends on the current measurement interval setting.</p> <p>The numbers are sent in the following order:</p> <p style="padding-left: 40px;">In-phase (I) sample, of symbol 0 decision point Quadrature-phase (Q) sample, of symbol 0 decision point ... In-phase (I) sample, of symbol 1 decision point Quadrature-phase (Q) sample, of symbol 1 decision point ...</p> <p>The trace can be interpolated to 2,4,8 points/chip selected with the display Points/Chip softkey. This will change the number of points between decision points in the trace, changing the number of I/Q pairs sent for each decision point.</p>
7 cdma2000 mode	<p>Returns series of floating point numbers of code level, code index, power (in dB), time offset (in ns), phase offset (in rad), and code domain error (in dB). The total number of results are six times of “number of active channels”. The number of active channels can be obtained by the 10th result of FETCH:RHO0 command.</p>
7 1xEV-DO mode	<p>The same as n=3. (Overall-1)</p> <p>This trace is available when the Measurement Channel Type Selection is All (CALCulate:RHO:TYPE = ALL)</p> <p>(Rho Overall-1 and Rho Overall-2 as specified in 3GPP2 TSG-C4.1 Recommended Minimum Performance Standard for cdma2000 High Rate Data Packet Access Network, 11.4.2 Waveform Quality Measurement section.)</p> <p>n=6, 7, 8, 9 are for Overall-1 data trace n=10, 11, 12, 13 are for Overall-2 data trace</p> <p>In all cases, returns one full slot data points, but only portion of EVM computation is performed are valid. All other portion is 0.0</p>

n	Results Returned
<p>7 W-CDMA mode</p>	<p>With a device of BTS, it returns a series of floating point numbers: symbol rate (ex. 7.5 ksps), OVVSF code number, a dummy value, power level and code domain error for the active channels.</p> <p>With a device of MS, it returns a series of floating point numbers: symbol rate (ex. 15 ksps), OVVSF code number, 1.0 (I) or -1.0 (Q), power level and code domain error for the active channels. The results would look like the following:</p> <p>1st number = Symbol Rate for 1st Active Channel          2nd number = OVVSF Code number for 1st Active Channel          3rd number = (in BTS) -999, or (in MS) either +1 (I) or -1 (Q) for 1st Active Channel          4th number = Power Level (in dB) for 1st Active Channel          5th number = Code Domain Error for 1st Active Channel          ...          (N-1)*5+1 number = Symbol Rate for Nth Active Channel          (N-1)*5+2 number = OVVSF Code number for Nth Active Channel          (N-1)*5+3 number = -999 (in BTS), or either +1 (I) or -1 (Q) (in MS) for Nth Active Channel          (N-1)*5+4 number = Power Level (in dB) for Nth Active Channel          N*5 number = Code Domain Error for Nth Active Channel</p> <p>Number of active channel is given by 10th parameter of :MEASure:RHO[1].</p>
<p>8 cdmaOne mode</p>	<p>complementary filtered reference data – returns a series of floating point numbers that alternately represent I and Q pairs of the complementary filtered reference data. This is inverse filtered data of the inter-symbol interference in CDMA signals due to the digital transmission filters defined in the standard as well as the base station phase equalization filter.</p> <p>The number of trace points depends on the current measurement interval setting.</p> <p>The numbers are sent in the following order:</p> <p>In-phase (I) sample, of symbol 0 decision point          Quadrature-phase (Q) sample, of symbol 0 decision point          ...          In-phase (I) sample, of symbol 1 decision point          Quadrature-phase (Q) sample, of symbol 1 decision point          ...</p> <p>The trace can be interpolated to 2,4,8 points/chip selected with the display Points/Chip softkey. This will change the number of points between decision points in the trace, changing the number of I/Q pairs sent for each decision point.</p>



<b>n</b>	<b>Results Returned</b>
<p>8 W-CDMA mode</p>	<p>Returns a series of floating point numbers (in dB) that represents all the code domain powers.</p> <p>With a device of BTS, there are 512 numbers. If the active channel occupies more than the max spreading factor (7.5 ksps) the power is duplicated (active symbol rate/7.5 ksps) times.</p> <p>1st number = 1st code power over the slot 2nd number = 2nd code power over the slot ... Nth number = Nth code power over the slot</p> <p>With a device of MS, there are 256 I/Q pairs. If the active channel occupies more than the max spreading factor (15 ksps) the power is duplicated (active symbol rate / 15 ksps) times.</p> <p>1st number = 1st in-phase code power over the slot 2nd number = 1st quad-phase code power over the slot ... (2*N-1) number = Nth in-phase code power over the slot (2 *N) number = Nth quad-phase code power over a slot</p> <p>N = the number of codes detected. The total number of codes varies because of the different symbol rates of each code.</p>
<p>8 1xEV-DO mode</p>	<p>The same as n=4. (Overall-1)</p> <p>This trace is available when the Measurement Channel Type Selection is All (CALCulate:RHO:TYPE = ALL)</p> <p>(Rho Overall-1 and Rho Overall-2 as specified in 3GPP2 TSG-C4.1 Recommended Minimum Performance Standard for cdma2000 High Rate Data Packet Access Network, 11.4.2 Waveform Quality Measurement section.)</p> <p>n=6, 7, 8, 9 are for Overall-1 data trace n=10, 11, 12, 13 are for Overall-2 data trace</p> <p>In all cases, returns one full slot data points, but only portion of EVM computation is performed are valid. All other portion is 0.0</p>

<b>n</b>	<b>Results Returned</b>
<p>9 1xEV-DO mode</p>	<p>The same as n=5. (Overall-1)</p> <p>This trace is available when the Measurement Channel Type Selection is All            (CALCulate:RHO:TYPE = ALL)</p> <p>(Rho Overall-1 and Rho Overall-2 as specified in 3GPP2 TSG-C4.1 Recommended Minimum Performance Standard for cdma2000 High Rate Data Packet Access Network, 11.4.2 Waveform Quality Measurement section.)</p> <p>n=6, 7, 8, 9 are for Overall-1 data trace            n=10, 11, 12, 13 are for Overall-2 data trace</p> <p>In all cases, returns one full slot data points, but only portion of EVM computation is performed are valid. All other portion is 0.0</p>
<p>10 1xEV-DO mode</p>	<p>The same as n=2. (Overall-2)</p> <p>This trace is available when the Measurement Channel Type Selection is All            (CALCulate:RHO:TYPE = ALL)</p> <p>(Rho Overall-1 and Rho Overall-2 as specified in 3GPP2 TSG-C4.1 Recommended Minimum Performance Standard for cdma2000 High Rate Data Packet Access Network, 11.4.2 Waveform Quality Measurement section.)</p> <p>n=6, 7, 8, 9 are for Overall-1 data trace            n=10, 11, 12, 13 are for Overall-2 data trace</p> <p>In all cases, returns one full slot data points, but only portion of EVM computation is performed are valid. All other portion is 0.0</p>
<p>11 cdmaOne mode</p>	<p>Corrected measured data – returns a series of floating point numbers that alternately represent I and Q pairs of the corrected measured trace data. The magnitude of each I and Q pair are normalized to 1.0.</p> <p>The number of trace points depends on the current setting for the number of displayed I/Q points in the I/Q display.</p> <p>The numbers are sent in the following order:</p> <p style="padding-left: 40px;">In-phase (I) sample, of symbol 0 decision point            Quadrature-phase (Q) sample, of symbol 0 decision point            ...            In-phase (I) sample, of symbol 1 decision point            Quadrature-phase (Q) sample, of symbol 1 decision point            ...</p> <p>The trace can be interpolated to 2,4,8 points/chip selected with the display Points/Chip softkey. This will change the number of points between decision points in the trace, changing the number of I/Q pairs sent for each decision point.</p>

<b>n</b>	<b>Results Returned</b>
<p>11 1xEV-DO mode</p>	<p>The same as n=2. (Overall-2)</p> <p>This trace is available when the Measurement Channel Type Selection is All (CALCulate:RHO:TYPE = ALL)</p> <p>(Rho Overall-1 and Rho Overall-2 as specified in 3GPP2 TSG-C4.1 Recommended Minimum Performance Standard for cdma2000 High Rate Data Packet Access Network, 11.4.2 Waveform Quality Measurement section.)</p> <p>n=6, 7, 8, 9 are for Overall-1 data trace n=10, 11, 12, 13 are for Overall-2 data trace</p> <p>In all cases, returns one full slot data points, but only portion of EVM computation is performed are valid. All other portion is 0.0</p>
<p>12 1xEV-DO mode</p>	<p>The same as n=4. (Overall-2)</p> <p>This trace is available when the Measurement Channel Type Selection is All (CALCulate:RHO:TYPE = ALL)</p> <p>(Rho Overall-1 and Rho Overall-2 as specified in 3GPP2 TSG-C4.1 Recommended Minimum Performance Standard for cdma2000 High Rate Data Packet Access Network, 11.4.2 Waveform Quality Measurement section.)</p> <p>n=6, 7, 8, 9 are for Overall-1 data trace n=10, 11, 12, 13 are for Overall-2 data trace</p> <p>In all cases, returns one full slot data points, but only portion of EVM computation is performed are valid. All other portion is 0.0</p>

<b>n</b>	<b>Results Returned</b>
<p>13 cdmaOne mode</p>	<p>complementary filtered measured data – returns a series of floating point numbers that alternately represent I and Q pairs of the complementary filtered measured data. This is inverse filtered data of the inter-symbol interference in CDMA signals due to the digital transmission filters defined in the standard as well as the base station phase equalization filter.</p> <p>The number of trace points depends on the current setting for the number of displayed I/Q points in the I/Q display.</p> <p>The numbers are sent in the following order:</p> <p style="padding-left: 40px;">In-phase (I) sample, of symbol 0 decision point            Quadrature-phase (Q) sample, of symbol 0 decision point            ...            In-phase (I) sample, of symbol 1 decision point            Quadrature-phase (Q) sample, of symbol 1 decision point            ...</p> <p>The trace can be interpolated to 2,4,8 points/chip selected with the display Points/Chip softkey. This will change the number of points between decision points in the trace, changing the number of I/Q pairs sent for each decision point.</p>
<p>13 1xEV-DO mode</p>	<p>The same as n=5. (Overall-2)</p> <p>This trace is available when the Measurement Channel Type Selection is All            (CALCulate:RHO:TYPE = ALL)</p> <p>(Rho Overall-1 and Rho Overall-2 as specified in 3GPP2 TSG-C4.1 Recommended Minimum Performance Standard for cdma2000 High Rate Data Packet Access Network, 11.4.2 Waveform Quality Measurement section.)</p> <p>n=6, 7, 8, 9 are for Overall-1 data trace            n=10, 11, 12, 13 are for Overall-2 data trace</p> <p>In all cases, returns one full slot data points, but only portion of EVM computation is performed are valid. All other portion is 0.0</p>

n	Results Returned
<p>14 1xEV-DO mode</p>	<p>The same as n=5. (Overall-2) I/Q trace data is descrambled.</p> <p>This trace is available when the Measurement Channel Type Selection is All (CALCulate:RHO:TYPE = ALL)</p> <p>(Rho Overall-1 and Rho Overall-2 as specified in 3GPP2 TSG-C4.1 Recommended Minimum Performance Standard for cdma2000 High Rate Data Packet Access Network, 11.4.2 Waveform Quality Measurement section.)</p> <p>n=6, 7, 8, 9 are for Overall-1 data trace n=10, 11, 12, 13 are for Overall-2 data trace</p> <p>In all cases, returns one full slot data points, but only portion of EVM computation is performed are valid. All other portion is 0.0</p>
<p>15 1xEV-DO mode</p>	<p>Returns 10 comma-separated scalar values of the pass/fail (0.0=passed, or 1.0=failed) results determined by testing the EVM, Peak EVM:</p> <ol style="list-style-type: none"> <li>1. Test result of EVM</li> <li>2. Test result of Peak EVM</li> <li>3. Test result of Rho</li> <li>4. Test result of Frequency Error</li> </ol> <p>Following Timing and Phase results are valid only Multichannel Estimator is On and existence of multiple codes. When the measurement is not valid, the results are 0.0</p> <ol style="list-style-type: none"> <li>5. Test result of Timing</li> <li>6. Test result of Phase</li> </ol> <p>Following Pilot Offset result is valid only external trigger is selected. When the measurement is not valid, the result is 0.0</p> <ol style="list-style-type: none"> <li>7. Test result of Pilot Offset</li> </ol> <p>Following three results are valid exclusively. When the measurement is not valid, the result is 0.0</p> <ol style="list-style-type: none"> <li>8. Test result of Max MAC Inactive Channel Power</li> <li>9. Test result of Max Data Active Channel Power</li> <li>10. Test result of Min Data Active Channel Power</li> </ol>

## Spurious Emissions Measurement

This measures spurious emissions levels up to five pairs of offset/region frequencies and relates them to the carrier power. You must be in the cdma2000, W-CDMA or 1xEV-DO mode to use these commands. Use INSTRument:SElect to set the mode. For 1xEV-DO mode, this command will return spurious emissions measurements or adjacent channel power measurements, depending on which setting is selected using SENSE:SEMask:SEGment:TYPE ACPr|SEMask.

The general functionality of CONFigure, FETCh, MEASure, and READ are described at the beginning of this section. See the SENSE:SEMask commands for more measurement related commands.

```
:CONFigure:SEMask  
:INITiate:SEMask  
:FETCh:SEMask [n] ?  
:READ:SEMask [n] ?  
:MEASure:SEMask [n] ?
```

Front Panel

Access: **Measure, Spectrum Emission Mask**

After the measurement is selected, press **Restore Meas Defaults** to restore factory defaults.

### Measurement Results Available

Measurement Type	n	Results Returned
	0	Returns unprocessed I/Q trace data, as a series of trace point values, in volts.

Measurement Type	n	Results Returned
Total power reference	n=1 (or not specified)	<p>Returns 60 scalar results, in the following order:</p> <ol style="list-style-type: none"> <li>1. Reserved for future use, returns –999.0</li> <li>2. Absolute power at the center frequency (reference) area (dBm)</li> <li>3. Reserved for future use, returns –999.0</li> <li>4. Reserved for future use, returns –999.0</li> <li>5. Peak frequency in the center frequency (reference) area (Hz)</li> <li>6. Reserved for future use, returns –999.0</li> <li>7. Reserved for future use, returns –999.0</li> <li>8. Reserved for future use, returns –999.0</li> <li>9. Reserved for future use, returns –999.0</li> <li>10. Reserved for future use, returns –999.0</li> <li>11. Relative power on the negative offset A (dBc)</li> <li>12. Absolute power on the negative offset A (dBm)</li> <li>13. Relative peak power on the negative offset A (dBc)</li> <li>14. Absolute peak power on the negative offset A (dBm)</li> <li>15. Peak frequency in the negative offset A (Hz)</li> <li>16. Relative power on the positive offset A (dBc)</li> <li>17. Absolute power on the positive offset A (dBm)</li> <li>18. Relative peak power on the positive offset A (dBc)</li> <li>19. Absolute peak power on the positive offset A (dBm)</li> <li>20. Peak frequency in the positive offset A (Hz)</li> <li>21. Relative power on the negative offset B (dBc)</li> </ol> <p style="text-align: center;">. . .</p> <ol style="list-style-type: none"> <li>1. Absolute peak power on the positive offset E (dBm)</li> <li>2. Peak frequency in the positive offset E (Hz)</li> </ol> <p>When [:SENSe]:SEMask:SEGMENT is set to REGION, the positive offsets are not available and return –999.0.</p>

Measurement Type	n	Results Returned
Power spectral density reference	n=1 (or not specified)	<p>Returns 60 scalar results, in the following order:</p> <ol style="list-style-type: none"> <li>1. Reserved for future use, returns -999.0</li> <li>2. Absolute power at the center frequency (reference) area (dBm)</li> <li>3. Reserved for future use, returns -999.0</li> <li>4. Reserved for future use, returns -999.0</li> <li>5. Peak frequency in the center frequency (reference) area (Hz)</li> <li>6. Reserved for future use, returns -999.0</li> <li>7. Reserved for future use, returns -999.0</li> <li>8. Reserved for future use, returns -999.0</li> <li>9. Reserved for future use, returns -999.0</li> <li>10. Reserved for future use, returns -999.0</li> <li>11. Relative power on the negative offset A (dB)</li> <li>12. Absolute power on the negative offset A (dBm/Hz)</li> <li>13. Relative peak power on the negative offset A (dB)</li> <li>14. Absolute peak power on the negative offset A (dBm/Hz)</li> <li>15. Peak frequency in the negative offset A (Hz)</li> <li>16. Relative power on the positive offset A (dB)</li> <li>17. Absolute power on the positive offset A (dBm/Hz)</li> <li>18. Relative peak power on the positive offset A (dB)</li> <li>19. Absolute peak power on the positive offset A (dBm/Hz)</li> <li>20. Peak frequency in the positive offset A (Hz)</li> <li>21. Relative power on the negative offset B (dB)</li> </ol> <p style="text-align: center;">. . .</p> <ol style="list-style-type: none"> <li>1. Absolute peak power on the positive offset E (dBm/Hz)</li> <li>2. Peak frequency in the positive offset E (Hz)</li> </ol> <p>When [:SENSE]:SEMask:SEGMENT is set to REGION, the positive offsets are not available and return -999.0.</p>
	2	Returns the displayed frequency domain spectrum trace data separated by comma. The number of data is 2001 when DISPLAY:SEMask:VIEW is set to ALL.
	3	Returns the displayed frequency domain absolute limit trace data separated by comma. The number of data is 2001 when DISPLAY:SEMask:VIEW is set to ALL.
	4	Returns the displayed frequency domain relative limit trace data separated by comma. The number of data is 2001 when DISPLAY:SEMask:VIEW is set to ALL.



Measurement Type	n	Results Returned
Total power reference	5	<p>Returns 12 scalar values (in dBm) of the absolute power of the segment frequencies:</p> <ol style="list-style-type: none"> <li>1. Total power reference (dBm), for cdma2000 and W-CDMA Reserved for future use, returns -999.0, for 1xEV-DO</li> <li>2. Reserved for future use, returns -999.0</li> <li>3. Negative offset frequency (A) or region (A)</li> <li>4. Positive offset frequency (A)</li> </ol> <p style="text-align: center;">. . .</p> <ol style="list-style-type: none"> <li>1. Negative offset frequency (E) or region (E)</li> <li>2. Positive offset frequency (E)</li> </ol> <p>When [:SENSE]:SEMAsk:SEGMENT is set to REGION, the positive offsets are not available and return -999.0.</p>
Power spectral density reference	5	<p>Returns 12 scalar values (in dBm/Hz) of the absolute power of the segment frequencies:</p> <ol style="list-style-type: none"> <li>1. Power spectral density reference (dBm/Hz), for cdma2000 and W-CDMA Reserved for future use, returns -999.0, for 1xEV-DO</li> <li>2. Reserved for future use, returns -999.0</li> <li>3. Negative offset frequency (A) or region (A)</li> <li>4. Positive offset frequency (A)</li> </ol> <p style="text-align: center;">. . .</p> <ol style="list-style-type: none"> <li>1. Negative offset frequency (E) or region (E)</li> <li>2. Positive offset frequency (E)</li> </ol> <p>When [:SENSE]:SEMAsk:SEGMENT is set to REGION, the positive offsets are not available and return -999.0.</p>
Total power reference	6	<p>Returns 12 scalar values (in dBc) of the power relative to the carrier at the segment frequencies:</p> <ol style="list-style-type: none"> <li>1. Reserved for future use, returns -999.0</li> <li>2. Reserved for future use, returns -999.0</li> <li>3. Negative offset frequency (A) or region (A)</li> <li>4. Positive offset frequency (A)</li> </ol> <p style="text-align: center;">. . .</p> <ol style="list-style-type: none"> <li>1. Negative offset frequency (E) or region (E)</li> <li>2. Positive offset frequency (E)</li> </ol> <p>When [:SENSE]:SEMAsk:SEGMENT is set to REGION, the positive offsets are not available and return -999.0.</p>

Measurement Type	n	Results Returned
Power spectral density reference	6	<p>Returns 12 scalar values (in dBc) of the power relative to the carrier at the segment frequencies:</p> <ol style="list-style-type: none"> <li>1. Reserved for future use, returns -999.0</li> <li>2. Reserved for future use, returns -999.0</li> <li>3. Negative offset frequency (A) or region (A)</li> <li>4. Positive offset frequency (A)</li> </ol> <p style="text-align: center;">. . .</p> <ol style="list-style-type: none"> <li>1. Negative offset frequency (E) or region (E)</li> <li>2. Positive offset frequency (E)</li> </ol> <p>When [:SENSE]:SEMask:SEGMENT is set to REGION, the positive offsets are not available and return -999.0.</p>
	7	<p>Returns 12 pass/fail test results (0 = passed, or 1 = failed) determined by testing the absolute power of the segment frequencies:</p> <ol style="list-style-type: none"> <li>1. Reserved for future use, returns -999.0</li> <li>2. Reserved for future use, returns -999.0</li> <li>3. Negative offset frequency (A) or region (A)</li> <li>4. Positive offset frequency (A)</li> </ol> <p style="text-align: center;">. . .</p> <ol style="list-style-type: none"> <li>1. Negative offset frequency (E) or region (E)</li> <li>2. Positive offset frequency (E)</li> </ol> <p>When [:SENSE]:SEMask:SEGMENT is set to REGION, the positive offsets are not available and return -999.0.</p>
	8	<p>Returns 12 scalar values of the pass/fail (0=passed, or 1=failed) results determined by testing the power relative to the segment frequencies:</p> <ol style="list-style-type: none"> <li>1. Reserved for future use, returns -999.0</li> <li>2. Reserved for future use, returns -999.0</li> <li>3. Negative offset frequency (A) or region (A)</li> <li>4. Positive offset frequency (A)</li> </ol> <p style="text-align: center;">. . .</p> <ol style="list-style-type: none"> <li>1. Negative offset frequency (E) or region (E)</li> <li>2. Positive offset frequency (E)</li> </ol> <p>When [:SENSE]:SEMask:SEGMENT is set to REGION, the positive offsets are not available and return -999.0.</p>

Measurement Type	n	Results Returned
	9	<p>Returns 12 scalar values of frequency (in Hz) that have peak power in each offset/region:</p> <ol style="list-style-type: none"> <li>1. Reserved for future use, returns –999.0</li> <li>2. Reserved for future use, returns –999.0</li> <li>3. Negative offset frequency (A) or region (A)</li> <li>4. Positive offset frequency (A)</li> </ol> <p style="text-align: center;">. . .</p> <ol style="list-style-type: none"> <li>1. Negative offset frequency (E) or region (E)</li> <li>2. Positive offset frequency (E)</li> </ol> <p>When [:SENSE]:SEMask:SEGMENT is set to REGION, the positive offsets are not available and return –999.0.</p>
	10	<p>Returns 12 scalar values (in dBm) of the absolute peak power of the segment frequencies:</p> <ol style="list-style-type: none"> <li>1. Reserved for future use, returns –999.0</li> <li>2. Reserved for future use, returns –999.0</li> <li>3. Negative offset frequency (A) or region (A)</li> <li>4. Positive offset frequency (A)</li> </ol> <p style="text-align: center;">. . .</p> <ol style="list-style-type: none"> <li>1. Negative offset frequency (E) or region (E)</li> <li>2. Positive offset frequency (E)</li> </ol> <p>When [:SENSE]:SEMask:SEGMENT is set to REGION, the positive offsets are not available and return –999.0.</p>
	11	<p>Returns 12 scalar values (in dBc) of the peak power relative to the carrier at the segment frequencies:</p> <ol style="list-style-type: none"> <li>1. Reserved for future use, returns –999.0</li> <li>2. Reserved for future use, returns –999.0</li> <li>3. Negative offset frequency (A) or region (A)</li> <li>4. Positive offset frequency (A)</li> </ol> <p style="text-align: center;">. . .</p> <ol style="list-style-type: none"> <li>1. Negative offset frequency (E) or region (E)</li> <li>2. Positive offset frequency (E)</li> </ol> <p>When [:SENSE]:SEMask:SEGMENT is set to REGION, the positive offsets are not available and return –999.0.</p>

## Spectrum (Frequency Domain) Measurement

This measures the amplitude of your input signal with respect to the frequency. It provides spectrum analysis capability using FFT (fast Fourier transform) measurement techniques. You must be in the Basic, cdmaOne, cdma2000, 1xEV-DO, W-CDMA, GSM (w/EDGE), NADC, or PDC mode to use these commands. Use INSTRument:SElect, to select the mode.

The general functionality of CONFigure, FETCh, MEASure, and READ are described at the beginning of this section. See the SENSE:SPECTrum commands for more measurement related commands.

```
:CONFigure:SPECTrum  
:INITiate:SPECTrum  
:FETCh:SPECTrum [n] ?  
:READ:SPECTrum [n] ?  
:MEASure:SPECTrum [n] ?
```

Front Panel

Access: **Measure, Spectrum (Freq Domain)**

After the measurement is selected, press **Restore Meas Defaults** to restore factory defaults.

### Measurement Results Available

n	Results Returned
0	Returns unprocessed I/Q trace data, as a series of trace point values, in volts. The I values are listed first in each pair, using the 0 through even-indexed values. The Q values are the odd-indexed values.

n	Results Returned
n=1 (or not specified)	<p>Returns the following scalar results:</p> <ol style="list-style-type: none"> <li>1. <b>FFT peak</b> is the FFT peak amplitude.</li> <li>2. <b>FFT frequency</b> is the FFT frequency of the peak amplitude.</li> <li>3. <b>FFT points</b> is the Number of points in the FFT spectrum.</li> <li>4. <b>First FFT frequency</b> is the frequency of the first FFT point of the spectrum.</li> <li>5. <b>FFT spacing</b> is the frequency spacing between the FFT points of the spectrum.</li> <li>6. <b>Time domain points</b> is the number of points in the time domain trace used for the FFT. The number of points doubles if the data is complex instead of real. See the time domain scaler description below.</li> <li>7. <b>First time point</b> is the time of the first time domain point, where time zero is the trigger event.</li> <li>8. <b>Time spacing</b> is the time spacing between the time domain points. The time spacing value doubles if the data is complex instead of real. See the time domain scaler description below.</li> <li>9. <b>Time domain</b> returns a 1 if time domain is complex (I/Q) and complex data will be returned. It returns a 0 if the data is real. (raw ADC samples) When this value is 1 rather than 0 (complex vs. real data), the time domain points and the time spacing scalers both increase by a factor of two.</li> <li>10. <b>Scan time</b> is the total scan time of the time domain trace used for the FFT. The total scan time = (time spacing) X (time domain points – 1)</li> <li>11. <b>Current average count</b> is the current number of data measurements that have already been combined, in the averaging calculation.</li> </ol>
3	Returns the I and Q trace data. It is represented by I and Q pairs (in volts) versus time.
4	Returns spectrum trace data. That is, the trace of log-magnitude versus frequency. (The trace is computed using a FFT.)
6	Not used.
7	Returns the averaged spectrum trace data. That is, the trace of the averaged log-magnitude versus frequency.
8	Not used.
11, cdma2000, 1xEV-DO, W-CDMA, Basic modes only	Returns linear spectrum trace data values in Volts RMS.

<b>n</b>	<b>Results Returned</b>
12, cdma2000, 1xEV-DO, W-CDMA, Basic modes only	Returns averaged linear spectrum trace data values in Volts RMS.

## Waveform (Time Domain) Measurement

This measures the amplitude of your input signal with respect to the frequency. It provides spectrum analysis capability using FFT (fast Fourier transform) measurement techniques. You must be in the Basic, cdmaOne, cdma2000, 1xEV-DO, W-CDMA, GSM (w/EDGE), NADC, or PDC mode to use these commands. Use INSTRUMENT:SELEct, to select the mode.

The general functionality of CONFigure, FETCh, MEASure, and READ are described at the beginning of this section. See the SENSE:WAVEform commands for more measurement related commands.

```
:CONFigure:WAVEform
:INITiate:WAVEform
:FETCh:WAVEform [n] ?
:READ:WAVEform [n] ?
:MEASure:WAVEform [n] ?
```

Front Panel

Access: **Measure, Waveform (Time Domain)**

After the measurement is selected, press **Restore Meas Defaults** to restore factory defaults.

### Measurement Results Available

<b>n</b>	<b>Results Returned</b>
0 (see also 5)	Returns unprocessed I/Q trace data, as a series of trace point values, in volts. The I values are listed first in each pair, using the 0 through even-indexed values. The Q values are the odd-indexed values.

n	Results Returned
n=1 (or not specified)	<p>Returns the following scalar results:</p> <ol style="list-style-type: none"> <li>1. <b>Sample time</b> is a floating point number representing the time between samples when using the trace queries (n=0,2,etc).</li> <li>2. <b>Mean power</b> is the mean power (in dBm). This is either the power across the entire trace, or the power between markers if the markers are enabled. If averaging is on, the power is for the latest acquisition.</li> <li>3. <b>Mean power averaged</b> is the power (in dBm) for N averages, if averaging is on. This is either the power across the entire trace, or the power between markers if the markers are enabled. If averaging is on, the power is for the latest acquisition. If averaging is off, the value of the mean power averaged is the same as the value of the mean power.</li> <li>4. <b>Number of samples</b> is the number of data points in the captured signal. This number is useful when performing a query on the signal (i.e. when n=0,2,etc.).</li> <li>5. <b>Peak-to-mean ratio</b> has units of dB. This is the ratio of the maximum signal level to the mean power. Valid values are only obtained with averaging turned off. If averaging is on, the peak-to-mean ratio is calculated using the highest peak value, rather than the displayed average peak value.</li> <li>6. <b>Maximum value</b> is the maximum of the most recently acquired data (in dBm).</li> <li>7. <b>Minimum value</b> is the minimum of the most recently acquired data (in dBm).</li> </ol>
2	<p>Returns trace point values of the entire captured signal envelope trace data. These data points are floating point numbers representing the power of the signal (in dBm). There are N data points, where N is the <b>number of samples</b>. The period between the samples is defined by the <b>sample time</b>.</p>



---

## READ Subsystem

The READ? commands are used with several other commands and are documented in the section on the “[MEASure Group of Commands](#)” on [page 318](#).

### Initiate and Read Measurement Data

**:READ:<measurement> [n] ?**

A READ? query must specify the desired measurement. It will cause a measurement to occur without changing any of the current settings and will return any valid results. The code number n selects the kind of results that will be returned. The available measurements and data results are described in the “[MEASure Group of Commands](#)” on [page 318](#).

---

## SENSe Subsystem

These commands are used to set the instrument state parameters so that you can measure a particular input signal. Some SENSe commands are only for use with specific measurements found under the MEASURE key menu or the “MEASure Group of Commands” on page 318. The measurement must be active before you can use these commands.

The SCPI default for the format of any data output is ASCII. The format can be changed to binary with FORMat:DATA which transports faster over the bus.

### Adjacent Channel Power Measurement

Commands for querying the adjacent channel power measurement results and for setting to the default values are found in the “MEASure Group of Commands” on page 318. The equivalent front panel keys for the parameters described in the following commands, are found under the **Meas Setup** key, after the **ACP** or **ACPR** measurement has been selected from the **MEASURE** key menu.

#### Adjacent Channel Power—Average Count

```
[ :SENSe ] :ACP:AVERAge:COUNT <integer>
```

```
[ :SENSe ] :ACP:AVERAge:COUNT?
```

Set the number of data acquisitions that will be platform averaged. After the specified number of average counts, the average mode (termination control) setting determines the average action.

Factory Preset: 10 for cdma2000, W-CDMA

20 for Basic, cdmaOne

Range: 1 to 10,000

Remarks: Use INSTRument:SElect to set the mode.

Front Panel

Access: **Meas Setup**

#### Adjacent Channel Power—Averaging State

```
[ :SENSe ] :ACP:AVERAge [ :STATe ] OFF | ON | 0 | 1
```

```
[ :SENSe ] :ACP:AVERAge [ :STATe ] ?
```

Turn the averaging function On or Off.

Factory Preset: On

Remarks: Use INSTRument:SElect to set the mode.

Front Panel

Access: **Meas Setup**

### Adjacent Channel Power—Averaging Termination Control

```
[ :SENSE ] :ACP:AVERage:TCONtrol EXPonential | REPEAT
```

```
[ :SENSE ] :ACP:AVERage:TCONtrol?
```

Select the type of termination control used for averaging. This determines the averaging action after the specified number of data acquisitions (average count) is reached.

EXPonential – Each successive data acquisition after the average count is reached, is exponentially weighted and combined with the existing average.

REPEAT – After reaching the average count, the averaging is reset and a new average is started.

Factory Preset: REPEAT for cdmaOne, cdma2000, W-CDMA

EXPonential for NADC, PDC

Remarks: Use INSTRument:SElect to set the mode.

### Adjacent Channel Power—Carrier Channel BW

*cdma2000, W-CDMA mode*

```
[ :SENSE ] :ACP:BANDwidth [n] | BWIDth [n] :INTEgration <freq>
```

```
[ :SENSE ] :ACP:BANDwidth [n] | BWIDth [n] :INTEgration?
```

*cdmaOne mode*

```
[ :SENSE ] :ACP:BANDwidth [n] | BWIDth [n] :INTEgration [m] <freq>
```

```
[ :SENSE ] :ACP:BANDwidth [n] | BWIDth [n] :INTEgration [m] ?
```

Set the Integration bandwidth that will be used for the main (carrier) channel.

BANDwidth[n] | BWIDth[n]: m=1 is base station and 2 is mobiles. The default is base station (1).

INTEgration[n]: m=1 is cellular bands and 2 is pcs bands. The default is cellular.

Factory Preset:

Mode	Format (Modulation Standard)		
cdmaOne	1.23 MHz		
cdma2000	1.23 MHz		
W-CDMA	3.84 MHz		

Range: 300 Hz to 20 MHz for cdmaOne, cdma2000, W-CDMA mode

Default Unit: Hz

Remarks: With measurement type set at (TPR) total power reference, 1.40 MHz is sometimes used. Using 1.23 MHz will give a power that is very nearly identical to the 1.40 MHz value, and using 1.23 MHz will also yield the correct power spectral density with measurement type set at (PSD) reference. However, a setting of 1.40 MHz will not give the correct results with measurement type set at PSD reference.

You must be in cdmaOne, cdma2000, W-CDMA mode to use this command. Use INSTRument:SElect to set the mode.

### Adjacent Channel Power—Absolute Amplitude Limits

*cdmaOne mode*

```
[ :SENSe ] :ACP:OFFSet:LIST:ABSolute
<power>, <power>, <power>, <power>, <power>
```

```
[ :SENSe ] :ACP:OFFSet:LIST:ABSolute?
```

*cdma2000, W-CDMA mode*

```
[ :SENSe ] :ACP:OFFSet [n] :LIST:ABSolute
<power>, <power>, <power>, <power>, <power>
```

```
[ :SENSe ] :ACP:OFFSet [n] :LIST:ABSolute?
```

Sets the absolute amplitude levels to test against for each of the custom offsets. The list must contain five (5) entries. If there is more than one offset, the offset closest to the carrier channel is the first one in the list. [:SENSe]:ACP:OFFSet[n]:LIST[m]:TEST selects the type of testing to be done at each offset.

You can turn off (not use) specific offsets with the [:SENSe]:ACP:OFFSet[n]:LIST:STATe command.

The query returns the five (5) sets of the real numbers that are the current absolute amplitude test limits.

Offset[n]            n=1 is base station and 2 is mobiles. The default is base station (1).

List[n]             m=1 is cellular bands and 2 is pcs bands. The default is cellular.

Factory Preset:

Mode	Variant	Offset A	Offset B	Offset C	Offset D	Offset E
<b>cdmaOne</b>	BS cellular	0 dBm	0 dBm	0 dBm	0 dBm	0 dBm
	BS pcs	0 dBm	-13 dBm	-13 dBm	0 dBm	0 dBm
	MS cellular	0 dBm	0 dBm	0 dBm	0 dBm	0 dBm
	MS pcs	0 dBm	-13 dBm	-13 dBm	0 dBm	0 dBm
<b>cdma2000</b>		50 dBm	50 dBm	50 dBm	50 dBm	50 dBm
<b>W-CDMA</b>		50 dBm	50 dBm	50 dBm	50 dBm	50 dBm

Range:             -200.0 dBm to 50.0 dBm

Default Unit:    dBm

Remarks:        You must be in cdmaOne, cdma2000, W-CDMA mode to use this command. Use INSTRUMENT:SElect to set the mode.

### Adjacent Channel Power—Define Resolution Bandwidth List

*cdma2000, W-CDMA mode*

```
[ :SENSe ] :ACP:OFFSet [n] :LIST:BAWdth | BWIDth
<res_bw>, <res_bw>, <res_bw>, <res_bw>, <res_bw>
```

```
[ :SENSe ] :ACP:OFFSet [n] :LIST:BAWdth | BWIDth?
```

*cdmaOne mode*

```
[ :SENSe ] :ACP:OFFSet [n] :LIST [n] :BAWdth | BWIDth
<res_bw>, <res_bw>, <res_bw>, <res_bw>, <res_bw>
```

```
[ :SENSe ] :ACP:OFFSet [n] :LIST [n] :BAWdth | BWIDth?
```

Define the custom resolution bandwidth(s) for the adjacent channel power testing. If there is more than one bandwidth, the list must contain five (5) entries. Each resolution bandwidth in the list corresponds to an offset frequency in the list defined by [:SENSe]:ACP:OFFSet[n]:LIST[n]:FREQuency]. You can turn off (not use) specific offsets with the [:SENSe]:ACP:OFFSet[n]:LIST[n]:STAtE

command.

Offset[n] n=1 is base station and 2 is mobiles. The default is base station (1).

List[n] n=1 is cellular bands and 2 is pcs bands. The default is cellular.

Factory Preset:

Mode	Variant	Offset A	Offset B	Offset C	Offset D	Offset E
<b>cdmaOne</b>	BS cellular	30 kHz	30 kHz	30 kHz	30 kHz	30 kHz
	BS pcs	30 kHz	12.5 kHz	1 MHz	30 kHz	30 kHz
	MS cellular	30 kHz	30 kHz	30 kHz	30 kHz	30 kHz
	MS pcs	30 kHz	12.5 kHz	1 MHz	30 kHz	30 kHz
<b>cdma2000</b>		30 kHz	30 kHz	30 kHz	30 kHz	30 kHz
<b>W-CDMA</b>		3.84 MHz	3.84 MHz	3.84 MHz	3.84 MHz	3.84 MHz

Range: 300 Hz to 20 MHz for cdmaOne, Basic, cdma2000, W-CDMA mode

Default Unit: Hz

Remarks: You must be in cdmaOne, cdma2000, W-CDMA mode to use this command. Use INSTRument:SElect to set the mode.

### Adjacent Channel Power—Define Offset Frequency List

*cdma2000, W-CDMA mode*

```
[ :SENSe ] :ACP:OFFSet [n] :LIST [ :FREQuency ]
<f_offset>,<f_offset>,<f_offset>,<f_offset>,<f_offset>
```

```
[ :SENSe ] :ACP:OFFSet [n] :LIST [ :FREQuency ] ?
```

*cdmaOne mode*

```
[ :SENSe ] :ACP:OFFSet [n] :LIST [n] [ :FREQuency ]
<f_offset>,<f_offset>,<f_offset>,<f_offset>,<f_offset>
```

```
[ :SENSe ] :ACP:OFFSet [n] :LIST [n] [ :FREQuency ] ?
```

Define the custom set of offset frequencies at which the switching transient spectrum part of the ACP measurement will be made. The list contains five (5) entries for offset frequencies. Each offset frequency in the list corresponds to a reference bandwidth in the bandwidth list.

An offset frequency of zero turns the display of the measurement for that offset off, but the measurement is still made and reported. You can

turn off (not use) specific offsets with the  
[:SENSe]:ACP:OFFSet:LIST:STATe command.

Offset[n]            n=1 is base station and 2 is mobiles. The default is base  
station (1).

List[n]              n=1 is cellular bands and 2 is pcs bands. The default is  
cellular.

Factory Preset:

Mode	Variant	Offset A	Offset B	Offset C	Offset D	Offset E
<b>cdmaOne</b>	BS cellular	750 kHz	1.98 MHz	0 Hz	0 Hz	0 Hz
	BS pcs	885 kHz	1.25625 MHz	2.75 MHz	0 Hz	0 Hz
	MS cellular	885 kHz	1.98 MHz	0 Hz	0 Hz	0 Hz
	MS pcs	1.265 MHz	0 Hz	0 Hz	0 Hz	0 Hz
<b>cdma2000</b>	BTS	750 kHz	1.98 MHz	0 Hz	0 Hz	0 Hz
	MS	885 kHz	1.98 MHz	0 Hz	0 Hz	0 Hz
<b>W-CDMA</b>		5 MHz	10 MHz	15 MHz	20 MHz	25 MHz

Range:                0 Hz to 45 MHz for cdmaOne  
0 Hz to 100 MHz for cdma2000, W-CDMA

Default Unit:        Hz

Remarks:            You must be in cdmaOne, cdma2000, W-CDMA mode to  
use this command. Use INSTRument:SElect to set the  
mode.

### Adjacent Channel Power—Amplitude Limits Relative to the Carrier

*cdma2000, W-CDMA mode*

```
[:SENSe]:ACP:OFFSet[n]:LIST:RCARrier  
<rel_power>,<rel_power>,<rel_power>,<rel_power>,<rel_power>
```

```
[:SENSe]:ACP:OFFSet[n]:LIST:RCARrier?
```

*cdmaOne mode*

```
[:SENSe]:ACP:OFFSet[n]:LIST[n]:RCARrier  
<rel_power>,<rel_power>,<rel_power>,<rel_power>,<rel_power>
```

```
[:SENSe]:ACP:OFFSet[n]:LIST[n]:RCARrier?
```

Sets the amplitude levels to test against for any custom offsets. This

amplitude level is relative to the carrier amplitude. If multiple offsets are available, the list contains five (5) entries. The offset closest to the carrier channel is the first one in the list.

`[:SENSe]:ACP:OFFSet[n]:LIST[n]:TEST` selects the type of testing to be done at each offset.

You can turn off (not use) specific offsets with the `[:SENSe]:ACP:OFFSet[n]:LIST[n]:STATe` command.

The query returns the five (5) sets of the real numbers that are the current amplitude test limits, relative to the carrier, for each offset.

`Offset[n]` n=1 is base station and 2 is mobiles. The default is base station (1).

`List[n]` n=1 is cellular bands and 2 is pcs bands. The default is cellular.

Factory Preset:

Mode	Variant	Offset A	Offset B	Offset C	Offset D	Offset E
<b>cdmaOne</b>	BS cellular	-45 dBc	-60 dBc	0 dBc	0 dBc	0 dBc
	BS pcs	-45 dBc	0 dBc	0 dBc	0 dBc	0 dBc
	MS cellular	-42 dBc	-54 dBc	0 dBc	0 dBc	0 dBc
	MS pcs	-42 dBc	0 dBc	0 dBc	0 dBc	0 dBc
<b>cdma2000</b>		0 dBc	0 dBc	0 dBc	0 dBc	0 dBc
<b>W-CDMA</b>	BTS	-44.2 dBc	-49.2 dBc	-49.2 dBc	-49.2 dBc	-49.2 dBc
	MS	-32.2 dBc	-42.2 dBc	-42.2 dBc	-42.2 dBc	-42.2 dBc

Range: -150.0 dB to 50.0 dB for cdmaOne, cdma2000, W-CDMA

Default Unit: dB

Remarks: You must be in cdmaOne, cdma2000, W-CDMA mode to use this command. Use `INSTrument:SElect` to set the mode.

### Adjacent Channel Power—Amplitude Limits Relative to the Power Spectral Density

*cdma2000, W-CDMA mode*

```
[:SENSe]:ACP:OFFSet [n] :LIST:RPSDensity
<rel_power>,<rel_power>,<rel_power>,<rel_power>,<rel_power>
```

```
[:SENSe]:ACP:OFFSet [n] :LIST:RPSDensity?
```

*cdmaOne mode*



```
[ :SENSe ] :ACP:OFFSet [n] :LIST [n] :RPSDensity
<rel_power>, <rel_power>, <rel_power>, <rel_power>, <rel_power>
```

```
[ :SENSe ] :ACP:OFFSet [n] :LIST [n] :RPSDensity?
```

Sets the amplitude levels to test against for any custom offsets. This amplitude level is relative to the power spectral density. If multiple offsets are available, the list contains five (5) entries. The offset closest to the carrier channel is the first one in the list.

[ :SENSe ] :ACP:OFFSet [n] :LIST [n] :TEST selects the type of testing to be done at each offset.

You can turn off (not use) specific offsets with the [ :SENSe ] :ACP:OFFSet [n] :LIST :STATe command.

The query returns the five (5) sets of the real numbers that are the current amplitude test limits, relative to the power spectral density, for each offset.

Offset[n]            n=1 is base station and 2 is mobiles. The default is base station (1).

List[n]             n=1 is cellular bands and 2 is pcs bands. The default is cellular.

Factory Preset:

Mode	Variant	Offset A	Offset B	Offset C	Offset D	Offset E
<b>cdmaOne</b>	BS cellular	-28.87 dB	-43.87 dB	0 dB	0 dB	0 dB
	BS pcs	-28.87 dB	0 dB	0 dB	0 dB	0 dB
	MS cellular	-25.87 dB	-37.87 dB	0 dB	0 dB	0 dB
	MS pcs	-25.87 dB	0 dB	0 dB	0 dB	0 dB
<b>cdma2000</b>		0 dB	0 dB	0 dB	0 dB	0 dB
<b>W-CDMA</b>	BTS	-44.2 dBc	-49.2 dBc	-49.2 dBc	-49.2 dBc	-49.2 dBc
	MS	-32.2 dBc	-42.2 dBc	-42.2 dBc	-42.2 dBc	-42.2 dBc

Range:             -150.0 dB to 50.0 dB for cdmaOne, Basic, cdma2000, W-CDMA

Default Unit:    dB

Remarks:        You must be in cdmaOne, cdma2000, W-CDMA mode to use this command. Use INSTRument:SELEct to set the mode.

### Adjacent Channel Power—Control Offset Frequency List

*cdma2000, W-CDMA mode*

```
[[:SENSe]:ACP:OFFSet [n]:LIST:STATe OFF|ON|0|1, OFF|ON|0|1,
OFF|ON|0|1, OFF|ON|0|1, OFF|ON|0|1]
```

```
[[:SENSe]:ACP:OFFSet [n]:LIST:STATe?
```

*cdmaOne mode*

```
[[:SENSe]:ACP:OFFSet [n]:LIST[n]:STATe OFF|ON|0|1,
OFF|ON|0|1, OFF|ON|0|1, OFF|ON|0|1, OFF|ON|0|1]
```

```
[[:SENSe]:ACP:OFFSet [n]:LIST[n]:STATe?
```

Selects whether testing is to be done at the custom offset frequencies. The measured powers are tested against the absolute values defined with [:SENSe]:ACP:OFFSet:LIST:ABSolute, or the relative values defined with [:SENSe]:ACP:OFFSet:LIST:RPSDensity and [:SENSe]:ACP:OFFSet:LIST:RCARier.

Offset[n]            n=1 is base station and 2 is mobiles. The default is base station (1).

List[n]             n=1 is cellular bands and 2 is pcs bands. The default is cellular.

Factory Preset:

Mode	Variant	Offset A	Offset B	Offset C	Offset D	Offset E
<b>cdmaOne</b>	BS cellular	On	On	On	On	On
	BS pcs	On	On	On	On	On
	MS cellular	On	On	On	On	On
	MS pcs	On	On	On	On	On
<b>cdma2000</b>		On	On	Off	Off	Off
<b>W-CDMA</b>		On	On	Off	Off	Off

Remarks:            You must be in cdmaOne, cdma2000, W-CDMA mode to use this command. Use INSTrument:SElect to set the mode.

### Adjacent Channel Power—Define Type of Offset Frequency List

*cdma2000, W-CDMA mode*

```
[[:SENSe]:ACP:OFFSet [n]:LIST:TEST ABSolute|AND|OR|RELative,
ABSolute|AND|OR|RELative, ABSolute|AND|OR|RELative,
ABSolute|AND|OR|RELative, ABSolute|AND|OR|RELative]
```

```
[[:SENSe]:ACP:OFFSet [n]:LIST:TEST?
```

*cdmaOne mode*

```
[[:SENSe]:ACP:OFFSet[n]:LIST[n]:TEST
BSolute|AND|OR|RELative, ABSolute|AND|OR|RELative,
ABSolute|AND|OR|RELative, ABSolute|AND|OR|RELative,
ABSolute|AND|OR|RELative
```

```
[[:SENSe]:ACP:OFFSet[n]:LIST[n]:TEST?
```

Defines the type of testing to be done at any custom offset frequencies. The measured powers are tested against the absolute values defined with [:SENSe]:ACP:OFFSet[n]:LIST:ABSolute, or the relative values defined with [:SENSe]:ACP:OFFSet:LIST:RPSDensity and [:SENSe]:ACP:OFFSet:LIST:RCARrier.

You can turn off (not use) specific offsets with the [:SENS]:ACP:OFFSet:LIST:STATe command.

Offset[n]            n=1 is base station and 2 is mobiles. The default is base station (1).

List[n]             n=1 is cellular bands and 2 is pcs bands. The default is cellular.

The types of testing that can be done for each offset include:

- Absolute - Test the absolute power measurement. If it fails, then return a failure for the measurement at this offset.
- And - Test both the absolute power measurement and the power relative to the carrier. If they both fail, then return a failure for the measurement at this offset.
- Or - Test both the absolute power measurement and the power relative to the carrier. If either one fails, then return a failure for the measurement at this offset.
- Relative - Test the power relative to the carrier. If it fails, then return a failure for the measurement at this offset.
- OFF - Turns the power test off.

Factory Preset:

Mode	Variant	Offset A	Offset B	Offset C	Offset D	Offset E
<b>cdmaOne</b>	BS cellular	REL	REL	REL	REL	REL
	BS pcs	REL	ABS	ABS	REL	REL
	MS cellular	REL	REL	REL	REL	REL
	MS pcs	REL	ABS	ABS	REL	REL
<b>cdma2000</b>		REL	REL	REL	REL	REL
<b>W-CDMA</b>		REL	REL	REL	REL	REL

Remarks:            You must be in cdmaOne, cdma2000, W-CDMA mode to

use this command. Use INSTRument:SElect to set the mode.

### Adjacent Channel Power—Sweep Mode Resolution Bandwidth

```
[ :SENSe ] :ACP:SWEep:BANDwidth|BWIDth[:RESolution] <freq>
```

```
[ :SENSe ] :ACP:SWEep:BANDwidth|BWIDth[:RESolution] ?
```

Sets the resolution bandwidth when using the spectrum analyzer type sweep mode. See [ :SENSe ] :ACP:SWEep:TYPE.

Factory Preset: Auto coupled.

Range: 1.0 kHz to 1.0 MHz

Resolution: 1.0 kHz

Step Size: 1.0 kHz

Default Unit: Hz

Remarks: You must be in the cdmaOne cdma2000, W-CDMA mode to use this command. Use INSTRument:SElect to set the mode.

### Adjacent Channel Power—Sweep Mode Resolution BW Control

```
[ :SENSe ] :ACP:SWEep:BANDwidth|BWIDth[:RESolution]:AUTO  
OFF|ON|0|1
```

```
[ :SENSe ] :ACP:SWEep:BANDwidth|BWIDth[:RESolution]:AUTO?
```

Sets the resolution bandwidth to automatic, when using the spectrum analyzer type sweep mode. See [ :SENSe ] :ACP:SWEep:TYPE.

Factory Preset: ON

Remarks: You must be in the cdmaOne cdma2000, W-CDMA mode to use this command. Use INSTRument:SElect to set the mode.

### Adjacent Channel Power—Sweep Mode Detection

```
[ :SENSe ] :ACP:SWEep:DETEctor[:FUNCTION] AAverage|POSitive
```

```
[ :SENSe ] :ACP:SWEep:DETEctor[:FUNCTION] ?
```

Selects the detector type when using the sweep mode. See

```
[ :SENSe ] :ACP:SWEep:TYPE.
```

Absolute average (AAverage) - the absolute average power in each frequency is measured across the spectrum

Positive - the positive peak power in each frequency is measured across the spectrum

Factory Preset: POSitive

Remarks: You must be in the cdma2000, W-CDMA mode to use this command. Use INSTRument:SElect to set the mode.

### Adjacent Channel Power—Sweep Time

**[ :SENSE ] :ACP:SWEep:TIME <seconds>**

**[ :SENSE ] :ACP:SWEep:TIME?**

Selects a specific sweep time used to measure the reference (carrier) channel. If you increase the sweep time, you increase the length of the time data captured and the number of points measured. You might need to specify a specific sweep speed to accommodate a specific condition in your transmitter. For example, you may have a burst signal and need to measure an exact portion of the burst.

Selecting a specific sweep time may result in a long measurement time since the resulting number of data points may not be the optimum  $2^n$ . Use **[ :SENSE ] :ACP:OFFSet:LIST:SWEep:TIME** to set the number of points used for measuring the offset channels for Basic and cdmaOne.

For cdma2000 and W-CDMA, this command sets the sweep time when using the sweep mode. See **[ :SENSE ] :ACP:SWEep:TYPE**.

Factory Preset: 625  $\mu$ s (1 slot) for W-CDMA

1.25 ms for cdma2000

11.20 ms for cdmaOne

Range: 500  $\mu$ s to 10 ms for W-CDMA, cdma2000

1  $\mu$ s to 50 ms for cdmaOne

Default Unit: seconds

Remarks: You must be in the cdmaOne, cdma2000, W-CDMA mode to use this command. Use INSTRument:SElect to set the mode.

### Adjacent Channel Power—Sweep Type

*W-CDMA mode*

**[ :SENSE ] :ACP:SWEep:TYPE FAST | FFT | SWEep**

**[ :SENSE ] :ACP:SWEep:TYPE?**

*cdma2000 mode*

```
[ :SENSe ] :ACP:SWEep:TYPE FFT | SWEep
```

```
[ :SENSe ] :ACP:SWEep:TYPE?
```

Selects the type of sweeping.

Fast (*W-CDMA mode only*) - the data acquisition is made with the wide channel integration bandwidth and the time-domain data is divided into the narrow data to apply FFT. This mode is faster than the FFT mode but less accurate in power levels.

FFT - the data acquisition is made with the narrow channel integration bandwidth and apply fast Fourier transform (FFT) to convert to the frequency domain data.

Sweep - the measurement is made by the swept spectrum method like the traditional swept frequency spectrum analysis to have better correlation to the input signal with a high crest factor (peak/average ratio). This mode may take a longer time than the FFT mode. See [ :SENSe ] :ACP:SWEep:DETECTOR [ :FUNCTION ].

Factory Preset: FFT

Remarks: You must be in the cdma2000, W-CDMA mode to use this command. Use INSTRUMENT:SElect to set the mode.

### Adjacent Channel Power—Power Reference

```
[ :SENSe ] :ACP:TYPE PSDRef | TPreF
```

```
[ :SENSe ] :ACP:TYPE?
```

Selects the measurement type. This allows you to make absolute and relative power measurements of either total power or the power normalized to the measurement bandwidth.

Power Spectral Density Reference (PSDRef) - the power spectral density is used as the power reference

Total Power Reference (TPRef) - the total power is used as the power reference

Factory Preset: Total power reference (TPRef)

Remarks: You must be in the cdmaOne, cdma2000, W-CDMA, NADC, or PDC mode to use this command. Use INSTRUMENT:SElect to set the mode.

## Code Domain Measurement

Commands for querying the code domain power measurement results and for setting to the default values are found in the “MEASure Group of Commands” on page 318. The equivalent front panel keys for the parameters described in the following commands, are found under the **Meas Setup** key, after the **Code Domain** measurement has been selected from the **MEASURE** key menu.

### Code Domain—Data Capture Time

```
[ :SENSe ] :CDPower :CAPTure :TIME <numeric>
```

```
[ :SENSe ] :CDPower :CAPTure :TIME?
```

Set the data capture length in Power Control Groups (PCG; 1 PCG equals 1.25 ms) for cdma2000 and 1xEV-DO, or frames (1 frame equals 10 ms) for W-CDMA that will be used in the acquisition.

Factory Preset: 5 for cdma2000, 1xEV-DO

2.0 for W-CDMA

Range: 2 to 32 PCGs (2.5 to 40 ms) for cdma2000, 1xEV-DO

0.067 (any value below 1 is set to 0.067), 1.0, 2.0, 4.0, and 8.0 frames (0.67 to 80 ms; 1/15 frame equals 1 slot) for W-CDMA. Other numeric values between 1 and 8 are rounded to the nearest integer; entries between integers are rounded up, excepting for entries above 8 which are rounded down to 8.

Remarks: You must be in the cdma2000, W-CDMA, or 1xEV-DO mode to use this command. Use INSTRument:SElect to set the mode.

### Code Domain—Chip Rate

```
[ :SENSe ] :CDPower :CRATe <freq>
```

```
[ :SENSe ] :CDPower :CRATe?
```

Enter a frequency value to set the chip rate.

Factory Preset: 1.2288 MHz for cdma2000, 1xEV-DO

3.84 MHz for W-CDMA

Range: 1.10592 to 1.35168 MHz for cdma2000, 1xEV-DO

3.456 to 4.224 MHz for W-CDMA

Remarks: You must be in the cdma2000, W-CDMA, or 1xEV-DO mode to use this command. Use INSTRument:SElect to set the mode.

### Code Domain—Quasi-Orthogonal Function

```
[ :SENSe ] :CDPower:QOF 0 | 1 | 2 | 3
```

```
[ :SENSe ] :CDPower:QOF?
```

Set the Walsh code quasi-orthogonal function for expanding the number of downlink channels (subscribers).

Factory Preset: 0

Remarks: You must be in the cdma2000 mode to use this command. Use INSTRument:SElect to set the mode.

### Code Domain—Spectrum Normal/Invert

```
[ :SENSe ] :CDPower:SPECTrum INVert | NORMAl
```

```
[ :SENSe ] :CDPower:SPECTrum?
```

Set a spectrum either to normal or inverted for the demodulation related measurements. If set to INVert, the upper and lower spectrums are swapped.

Factory Preset: NORMAl

Remarks You must be in the cdmaOne, cdma2000, W-CDMA, or 1xEV-DO mode to use this command. Use INSTRument:SElect to set the mode.

### Code Domain—Measurement Interval

```
[ :SENSe ] :CDPower:SWEep:TIME <time>
```

```
[ :SENSe ] :CDPower:SWEep:TIME?
```

Set the length of the measurement interval that will be used.

Factory Preset: 1.250 ms

Range: 0.5 ms to 30 ms

Default Unit: seconds

Remarks: You must be in the cdmaOne mode to use this command. Use INSTRument:SElect to set the mode.

### Code Domain—Long Code Mask

```
[ :SENSe ] :CDPower:SYNC:LCMask <integer>
```



`[ :SENSe ] :CDPower:SYNC:LCMask?`

Set the long code mask for MS measurement.

Factory Preset: 2,199,023,255,552 (20,000,000,000h)

Range: 0 to 4,398,046,511,103 (0h to 3F,FFF,FFF,FFFh)

Remarks: You must be in the cdma2000 mode to use this command. Use INSTRument:SElect to set the mode.

### Code Domain—Trigger Source

`[ :SENSe ] :CDPower:TRIGger:SOURce`

`EXTernal [1] | External2 | FRAMe | IF | IMMEDIATE | RFBurst`

`[ :SENSe ] :CDPower:TRIGger:SOURce?`

Select one of the trigger sources used to control the data acquisitions.

EXTernal 1 – front panel external trigger input

EXTernal 2 – rear panel external trigger input

FRAMe – internal frame trigger

IF – internal IF envelope (video) trigger

IMMEDIATE – the next data acquisition is immediately taken, capturing the signal asynchronously (also called free run).

RFBurst – internal wideband RF burst envelope trigger that has automatic level control for periodic burst signals.

Factory Preset: IMMEDIATE

Remarks: You must be in the cdma2000, W-CDMA, or 1xEV-DO mode to use this command. Use INSTRument:SElect to set the mode.

Front Panel

Access: **Meas Setup, Trig Source**

## Channel Power Measurement

Commands for querying the channel power measurement results and for setting to the default values are found in the “MEASure Group of Commands” on page 318. The equivalent front panel keys for the parameters described in the following commands, are found under the **Meas Setup** key, after the **Channel Power** measurement has been selected from the **MEASURE** key menu.

### Channel Power—Average Count

```
[ :SENSe ] :CHPower:AVERAge:COUNT <integer>
```

```
[ :SENSe ] :CHPower:AVERAge:COUNT?
```

Set the number of data acquisitions that will be averaged. After the specified number of average counts, the averaging mode (terminal control) setting determines the averaging action.

Factory Preset: 20

200, for W-CDMA

Range: 1 to 10,000

Remarks: You must be in the cdmaOne, cdma2000, W-CDMA, 1xEV-DO mode to use this command. Use INSTRument:SElect to set the mode.

### Channel Power—Averaging State

```
[ :SENSe ] :CHPower:AVERAge [ :STATe ] OFF | ON | 0 | 1
```

```
[ :SENSe ] :CHPower:AVERAge [ :STATe ] ?
```

Turn averaging on or off.

Factory Preset: ON

Remarks: You must be in the cdmaOne, cdma2000, W-CDMA, 1xEV-DO mode to use this command. Use INSTRument:SElect to set the mode.

### Channel Power—Averaging Termination Control

```
[ :SENSe ] :CHPower:AVERAge:TCONTRol EXPonential | REPeat
```

```
[ :SENSe ] :CHPower:AVERAge:TCONTRol?
```

Select the type of termination control used for the averaging function. This determines the averaging action after the specified number of data acquisitions (average count) is reached.

EXPonential - Each successive data acquisition after the average

count is reached, is exponentially weighted and combined with the existing average.

REPeat - After reaching the average count, the averaging is reset and a new average is started.

Factory Preset: REPeat

Remarks: You must be in the cdmaOne, cdma2000, W-CDMA, 1xEV-DO mode to use this command. Use INSTRUMENT:SElect to set the mode.

### Channel Power—Integration BW

`[ :SENSE ] :CHPower:BANDwidth|BWIDth:INTEgration <freq>`

`[ :SENSE ] :CHPower:BANDwidth|BWIDth:INTEgration?`

Set the Integration BW (IBW) that will be used.

Factory Preset: 1.23 MHz for cdmaOne, cdma2000, 1xEV-DO  
5.0 MHz for W-CDMA

Range: 1 kHz to 10 MHz

Default Unit: Hz

Remarks: You must be in the cdmaOne, cdma2000, W-CDMA, 1xEV-DO mode to use this command. Use INSTRUMENT:SElect to set the mode.

### Channel Power—Span

`[ :SENSE ] :CHPower:FREQuency:SPAN <freq>`

`[ :SENSE ] :CHPower:FREQuency:SPAN?`

Set the frequency span that will be used.

Factory Preset: 2.0 MHz for Basic, cdmaOne, cdma2000, 1xEV-DO  
6.0 MHz for W-CDMA

Range: Dependent on the current setting of the channel power integration bandwidth

Default Unit: Hz

Remarks: You must be in the cdmaOne, cdma2000, W-CDMA, 1xEV-DO mode to use this command. Use INSTRUMENT:SElect to set the mode.

### Channel Power—Data Points

`[ :SENSe ] :CHPower:POINts <integer>`

`[ :SENSe ] :CHPower:POINts?`

Set the number of data points that will be used. Changing this will change the time record length and resolution BW that are used.

Factory Preset: 512

Range: 64 to 32768, in a 2<sup>n</sup> sequence

Remarks: You must be in the cdmaOne, cdma2000, W-CDMA, 1xEV-DO mode to use this command. Use INSTRument:SElect to set the mode.

### Channel Power—Data Points Auto

`[ :SENSe ] :CHPower:POINts:AUTO OFF | ON | 0 | 1`

`[ :SENSe ] :CHPower:POINts:AUTO?`

Select auto or manual control of the data points. This is an advanced control that normally does not need to be changed. Setting this to a value other than the factory default, may cause invalid measurement results.

OFF - the Data Points is uncoupled from the Integration BW.

ON - couples the Data Points to the Integration BW.

Factory Preset: ON

Remarks: You must be in the cdmaOne, cdma2000, W-CDMA, 1xEV-DO mode to use this command. Use INSTRument:SElect to set the mode.

### Channel Power—Sweep Time

`[ :SENSe ] :CHPower:SWEep:TIME <time>`

`[ :SENSe ] :CHPower:SWEep:TIME?`

Sets the sweep time when using the sweep mode.

Factory Preset: 68.27  $\mu$ s

17.07  $\mu$ s for W-CDMA

Range: 1  $\mu$ s to 50 ms

Default Unit: seconds

Remarks: You must be in the cdmaOne, cdma2000, W-CDMA, 1xEV-DO mode to use this command. Use

INSTRument:SElect to set the mode.

### Channel Power—Sweep Time

[ :SENSE ] :CHPower:SWEep:TIME:AUTO OFF | ON | 0 | 1

[ :SENSE ] :CHPower:SWEep:TIME:AUTO?

Selects the automatic sweep time, optimizing the measurement.

Factory Preset: ON

Remarks: You must be in the cdmaOne, cdma2000, W-CDMA, 1xEV-DO mode to use this command. Use INSTRument:SElect to set the mode.

### Channel Power—Trigger Source

[ :SENSE ] :CHPower:TRIGger:SOURce?

Select the trigger source used to control the data acquisitions. This is an Advanced control that normally does not need to be changed.

EXTernal 1 - front panel external trigger input

EXTernal 2 - rear panel external trigger input

IMMEDIATE - the next data acquisition is immediately taken (also called Free Run).

Factory Preset: IMMEDIATE

Remarks: You must be in the cdmaOne, cdma2000, W-CDMA, 1xEV-DO mode to use this command. Use INSTRument:SElect to set the mode.

## Signal Corrections Commands

### Correction for BTS RF Port External Attenuation

`[ :SENSe ] :CORRection:BTS[:RF]:LOSS <rel_power>`

`[ :SENSe ] :CORRection:BTS[:RF]:LOSS?`

Set equal to the external attenuation used when measuring base transmission stations.

Factory Preset: 0.0 dB

Range:            -50 to 100.0 dB for GSM, EDGE  
                  -100.0 to 100.0 dB for cdma2000, W-CDMA, 1xEV-DO

Default Unit: dB

Remarks:        Global to the current mode.

You must be in the GSM, EDGE, cdma2000, W-CDMA, 1xEV-DO mode to use this command. Use INSTRUMENT:SElect to set the mode.

### Correction for MS RF Port External Attenuation

`[ :SENSe ] :CORRection:MS[:RF]:LOSS <rel_power>`

`[ :SENSe ] :CORRection:MS[:RF]:LOSS?`

Set the correction equal to the external attenuation used when measuring mobile stations.

Factory Preset: 0.0 dB

Range:            -50 to 100.0 dB for cdmaOne, GSM, EDGE  
                  -100.0 to 100.0 dB for cdma2000, W-CDMA, 1xEV-DO  
                  -50.0 to 50.0 dB for NADC, PDC

Default Unit: dB

Remarks:        You must be in the cdmaOne, GSM (w/EDGE), cdma2000, W-CDMA, NADC, PDC, 1xEV-DO mode to use this command. Use INSTRUMENT:SElect to set the mode.

Value is global to the current mode.

## QPSK Error Vector Magnitude Measurement

Commands for querying the QPSK error vector magnitude measurement results and for setting to the default values are found in the “MEASure Group of Commands” on page 318. The equivalent front panel keys for the parameters described in the following commands, are found under the **Meas Setup** key, after the **QPSK EVM** measurement has been selected from the **MEASURE** key menu.

### QPSK Error Vector Magnitude—Average Count

```
[ :SENSe ] :EVMQpsk:AVERAge:COUNT <integer>
```

```
[ :SENSe ] :EVMQpsk:AVERAge:COUNT?
```

Set the number of data acquisitions that will be averaged. After the specified number of average counts, the average mode (termination control) setting determines the average action.

Factory Preset: 10

Range: 1 to 10,000

Remarks: You must be in the cdma2000, W-CDMA, or 1xEV-DO mode to use this command. Use INSTRument:SElect to set the mode.

### QPSK Error Vector Magnitude—Averaging State

```
[ :SENSe ] :EVMQpsk:AVERAge [:STATe] OFF | ON | 0 | 1
```

```
[ :SENSe ] :EVMQpsk:AVERAge [:STATe] ?
```

Turn the averaging function on or off.

Factory Preset: ON

Remarks: You must be in the cdma2000, W-CDMA, or 1xEV-DO mode to use this command. Use INSTRument:SElect to set the mode.

### QPSK Error Vector Magnitude—Averaging Termination Control

```
[ :SENSe ] :EVMQpsk:AVERAge:TCONtrol EXPonential | REPeat
```

```
[ :SENSe ] :EVMQpsk:AVERAge:TCONtrol?
```

Select the type of termination control used to averaging. This determines the averaging action after the specified number of data acquisitions (average count) is reached.

EXPonential – Each successive data acquisition after the average

count is reached, is exponentially weighted and combined with the existing average.

REPeat – After reaching the average count, the averaging is reset and a new average is started.

Factory Preset: REPeat

Remarks: You must be in the cdma2000, W-CDMA, or 1xEV-DO mode to use this command. Use INSTRument:SElect to set the mode.

### QPSK Error Vector Magnitude—Chip Rate

[[:SENSe]:EVMQpsk:CRATe <freq>

[[:SENSe]:EVMQpsk:CRATe?

Enter a frequency value to set the chip rate.

Factory Preset: 1.2288 MHz for cdma2000, 1xEV-DO  
3.84 MHz for W-CDMA

Range: 1.10592 to 1.35168 MHz for cdma2000, 1xEV-DO  
3.456 to 4.224 MHz for W-CDMA

Default Unit: Hz

Remarks: You must be in the cdma2000, W-CDMA, or 1xEV-DO mode to use this command. Use INSTRument:SElect to set the mode.

### QPSK Error Vector Magnitude—RF Carrier Mode

[[:SENSe]:EVMQpsk:RFCarrier MULTiple|SINGLE

[[:SENSe]:EVMQpsk:RFCarrier?

Select either the single carrier mode or the multiple carrier mode.

MULTiple – The measurement assumes that the input signal is the multiple carriers with adjacent channel signals. The filter is used to cut the adjacent channel signals. (The filter may affect the measurement result.)

SINGLE – The measurement assumes that the input signal is the single carrier without adjacent channel signals. No filter is used for better measurement.

Factory Preset: SINGLE

Remarks: You must be in the cdma2000 or 1xEV-DO mode to use this command. Use INSTRument:SElect to set the



mode.

### QPSK Error Vector Magnitude—Measurement Interval

`[ :SENSE ] :EVMQpsk :SWEep :POINTs <integer>`

`[ :SENSE ] :EVMQpsk :SWEep :POINTs?`

Set the number of data points that will be used as the measurement interval.

Factory Preset: 256 chips

96 chips for 1xEV-DO

Range: 128 to 1536 chips for cdma2000

128 to 512 chips for W-CDMA

32 to 2048 chips for 1xEV-DO

Remarks: You must be in the cdma2000, W-CDMA, or 1xEV-DO mode to use this command. Use INSTRUMENT:SELEct to set the mode.

### QPSK Error Vector Magnitude—Trigger Source

`[ :SENSE ] :EVMQpsk :TRIGger :SOURce`

`EXTErnal [1] | EXTErnal2 | FRAMe | IF | IMMEdiate | RFBurst`

`[ :SENSE ] :EVMQpsk :TRIGger :SOURce?`

Select one of the trigger sources used to control the data acquisitions.

EXTErnal 1 – front panel external trigger input

EXTErnal 2 – rear panel external trigger input

FRAMe – internal frame trigger

IF – internal IF envelope (video) trigger

IMMEdiate – the next data acquisition is immediately taken, capturing the signal asynchronously (also called free run)

RFBurst – wideband RF burst envelope trigger that has automatic level control for periodic burst signals

Factory Preset: IMMEdiate

Remarks: You must be in the cdma2000, W-CDMA, or 1xEV-DO mode to use this command. Use INSTRUMENT:SELEct to set the mode.

## RF Input Signal Alignments

### Select the Input Signal

```
[ :SENSe ] :FEED RF | AREFERENCE | IFALIGN
```

```
[ :SENSe ] :FEED?
```

Selects the input signal. The default input signal is taken from the front panel RF input port. For calibration and testing purposes the input signal can be taken from an internal 321.4 MHz IF alignment signal or an internal 50 MHz amplitude reference source.

RF selects the signal from the front panel RF INPUT port.

AREFERENCE selects the internal 50 MHz amplitude reference signal.

IFALIGN selects the internal, 321.4 MHz, IF alignment signal.

Factory Preset: RF

Front Panel

Access: **Input, Input Port**

## Intermodulation Measurement

Commands for querying the intermodulation measurement results and for setting to the default values are found in the “MEASure Group of Commands” on page 318. The equivalent front panel keys for the parameters described in the following commands, are found under the **Meas Setup** key, after the **Intermod** measurement has been selected from the **MEASURE** key menu.

### Intermodulation—Average Count

```
[ :SENSe ] : IM : AVERAge : COUNT <number>
```

```
[ :SENSe ] : IM : AVERAge : COUNT ?
```

Set the number of data acquisitions that will be averaged. After the specified number of average counts, the average mode (termination control) setting determines the average action.

Factory Preset: 10

Range: 1 to 10,000

Remarks: You must be in the cdma2000, W-CDMA, or 1xEV-DO mode to use this command. Use INSTRument:SElect to set the mode.

### Intermodulation—Averaging State

```
[ :SENSe ] : IM : AVERAge [ :STATe ] OFF | ON | 0 | 1
```

```
[ :SENSe ] : IM : AVERAge [ :STATe ] ?
```

Turn the averaging function on or off.

Factory Preset: ON

Remarks: You must be in the cdma2000, W-CDMA, or 1xEV-DO mode to use this command. Use INSTRument:SElect to set the mode.

### Intermodulation—Averaging Termination Control

```
[ :SENSe ] : IM : AVERAge : TCONTrOl EXPOnentiaL | REPeat
```

```
[ :SENSe ] : IM : AVERAge : TCONTrOl ?
```

Select the type of termination control used for averaging. This determines the averaging action after the specified number of data acquisitions (average count) is reached.

EXPOnentiaL – Each successive data acquisition after the average count is reached, is exponentially weighted and combined with the

existing average.

REPeat – After reaching the average count, the averaging is reset and a new average is started.

Factory Preset: REPeat

Remarks: You must be in the cdma2000, W-CDMA, or 1xEV-DO mode to use this command. Use INSTRument:SElect to set the mode.

### Intermodulation—Integration Bandwidth

```
[ :SENSe ] :IM:BANDwidth | BWIDth:INTEgration <freq>
```

```
[ :SENSe ] :IM:BANDwidth | BWIDth:INTEgration?
```

Set the Integration Bandwidth (IBW) that will be used.

Factory Preset: 1.23 MHz for cdma2000, 1xEV-DO  
3.84 MHz for W-CDMA

Range: 100.0 kHz to 5.0 MHz

Default Unit: Hz

Remarks: You must be in the cdma2000, W-CDMA, or 1xEV-DO mode to use this command. Use INSTRument:SElect to set the mode.

### Intermodulation—Resolution Bandwidth

```
[ :SENSe ] :IM:BANDwidth | BWIDth[:RESolution] <freq>
```

```
[ :SENSe ] :IM:BANDwidth | BWIDth[:RESolution]?
```

Set the resolution bandwidth that will be used for the Transmitter IM measurement mode. If span is set to a value greater than 5 MHz, minimum resolution bandwidth is limited to 1 kHz.

Factory Preset: Auto coupled.

Range: 100 Hz to 300.0 kHz

Default Unit: Hz

Remarks: You must be in the cdma2000, W-CDMA, or 1xEV-DO mode to use this command. Use INSTRument:SElect to set the mode.

### Intermodulation—Resolution Bandwidth State

`[ :SENSE ] :IM:BANDwidth|BWIDth[:RESolution] :AUTO OFF|ON|0|1`

`[ :SENSE ] :IM:BANDwidth|BWIDth[:RESolution] :AUTO?`

Select auto (default value) or manual (user entered value) to set the resolution bandwidth.

Factory Preset: ON

Remarks: You must be in the cdma2000, W-CDMA, or 1xEV-DO mode to use this command. Use INSTRUMENT:SElect to set the mode.

### Intermodulation—Base Frequency Auto Search

`[ :SENSE ] :IM:FREQuency:AUTO OFF|ON|0|1`

`[ :SENSE ] :IM:FREQuency:AUTO?`

Turn the base frequency auto search function on or off.

OFF – the frequencies set by the `[ :SENSE ] :IM:FREQuency` are used.

ON – automatically determined by searching the entire span.

Factory Preset: ON

Remarks: You must be in the cdma2000, W-CDMA, or 1xEV-DO mode to use this command. Use INSTRUMENT:SElect to set the mode.

### Intermodulation—Base Frequencies Delta

`[ :SENSE ] :IM:FREQuency[:BASE] :DELTA <freq>`

`[ :SENSE ] :IM:FREQuency[:BASE] :DELTA?`

Set the delta frequency which is (the base upper frequency – the base lower frequency).

Factory Preset: Auto coupled.

Range: –3.0000 GHz to 3.0000 GHz

Default Unit: Hz

Remarks: Frequency step value is set by  
`[ :SENSE ] :FREQuency:CENTer:STEP[:INCRement]`

You must be in the cdma2000, W-CDMA, or 1xEV-DO mode to use this command. Use INSTRUMENT:SElect to set the mode.

### Intermodulation—Base Lower Frequency

`[ :SENSe ] :IM:FREQuency [ :BASE ] :LOWer <freq>`

`[ :SENSe ] :IM:FREQuency [ :BASE ] :LOWer?`

Set the frequency value of the base lower frequency. The available lower limit value is dependent on the Resolution Bandwidth setting.

Factory Preset: Auto coupled.

Range: 1 kHz to 3.0 GHz

Default Unit: Hz

Remarks: Frequency step value is set by  
`[ :SENSe ] :FREQuency:CENTer:STEP [ :INCRement ]`

You must be in the cdma2000, W-CDMA, or 1xEV-DO mode to use this command. Use INSTRument:SElect to set the mode.

### Intermodulation—Base Upper Frequency

`[ :SENSe ] :IM:FREQuency [ :BASE ] :UPPer <freq>`

`[ :SENSe ] :IM:FREQuency [ :BASE ] :UPPer?`

Set the frequency value of the base upper frequency. The available lower limit value is dependent on the Resolution Bandwidth setting.

Factory Preset: Auto coupled.

Range: 1 kHz to 3.0 GHz

Default Unit: Hz

Remarks: Frequency step value is set by  
`[ :SENSe ] :FREQuency:CENTer:STEP [ :INCRement ]`

You must be in the cdma2000, W-CDMA, or 1xEV-DO mode to use this command. Use INSTRument:SElect to set the mode.

### Intermodulation—Span

`[ :SENSe ] :IM:FREQuency:SPAN <freq>`

`[ :SENSe ] :IM:FREQuency:SPAN?`

Set the span.

Factory Preset: 20.0 MHz for cdma2000, 1xEV-DO  
50.0 MHz for W-CDMA

Range: 100.0 kHz to 100.0 MHz  
 Default Unit: Hz  
 Remarks: You must be in the cdma2000, W-CDMA, or 1xEV-DO mode to use this command. Use INSTRUMENT:SElect to set the mode.

### Intermodulation—Measurement Mode

[ :SENSE ] :IM:MODE AUTO | TWOTone | TXIM

[ :SENSE ] :IM:MODE?

Select the measurement mode of the intermodulation measurement.

AUTO – Automatically identifies the intermodulation caused by the two-tone or transmit intermodulation signals.

Two-tone (TWOTone)– Measures the two-tone intermodulation products.

Transmit (TXIM)– Measures the transmit intermodulation products.

Factory Preset: AUTO

Remarks: You must be in the cdma2000, W-CDMA, or 1xEV-DO mode to use this command. Use INSTRUMENT:SElect to set the mode.

### Intermodulation—Measurement Reference

[ :SENSE ] :IM:REference AUTO | AVERage | LOWER | UPPER

[ :SENSE ] :IM:REference?

Select the measurement reference of the intermodulation measurement.

AUTO – Automatically sets the highest level signal in two base signals as measurement reference.

AVERage – Sets the average level of the base lower carrier and upper carrier frequency as measurement reference.

LOWER – Sets the base lower carrier as measurement reference.

UPPER – Sets the base upper carrier as measurement reference.

Factory Preset: AUTO

Remarks: You must be in the cdma2000, W-CDMA, or 1xEV-DO mode to use this command. Use INSTRUMENT:SElect to set the mode.





## Occupied Bandwidth Measurement

Commands for querying the occupied bandwidth measurement results and for setting to the default values are found in the “MEASure Group of Commands” on page 318. The equivalent front panel keys for the parameters described in the following commands, are found under the **Meas Setup** key, after the **Occupied BW** measurement has been selected from the **MEASURE** key menu.

### Occupied Bandwidth—Average Count

```
[ :SENSe ] :OBW:AVERAge:COUNT <integer>
```

```
[ :SENSe ] :OBW:AVERAge:COUNT?
```

Set the number of data acquisitions that will be averaged. After the specified number of average counts, the average mode (termination control) setting determines the average action.

Factory Preset: 10

Range: 1 to 10,000

Remarks: This command is used for measurements in the MEASURE menu.

You must be in the PDC, cdma2000, W-CDMA, or 1xEV-DO mode to use this command. Use INSTRument:SElect to set the mode.

Front Panel

Access: **Meas Setup, Avg Number**

### Occupied Bandwidth—Averaging State

```
[ :SENSe ] :OBW:AVERAge [ :STATe ] OFF | ON | 0 | 1
```

```
[ :SENSe ] :OBW:AVERAge [ :STATe ] ?
```

Turn the averaging function on or off.

Factory Preset: ON

Remarks: You must be in the PDC, cdma2000, W-CDMA, or 1xEV-DO mode to use this command. Use INSTRument:SElect to set the mode.

Front Panel

Access: **Meas Setup, Avg Number**

### Occupied Bandwidth—Averaging Termination Control

```
[ :SENSe ] :OBW:AVERAge:TCONtrol EXPonential | REPEAT
```

`[ :SENSe ] :OBW:AVERAge:TCONtrol?`

Select the type of termination control used for the averaging function. This determines the averaging action after the specified number of data acquisitions (average count) is reached.

EXPonential - After the average count is reached, each successive data acquisition is exponentially weighted and combined with the existing average.

REPeat - After reaching the average count, the averaging is reset and a new average is started.

Factory Preset: EXPonential for PDC

REPeat for cdma2000, W-CDMA, 1xEV-DO

Remarks: You must be in the PDC, cdma2000, W-CDMA, or 1xEV-DO mode to use this command. Use INSTRument:SElect to set the mode.

Front Panel

Access: **Meas Setup, Avg Mode**

### Occupied Bandwidth—Resolution Bandwidth

`[ :SENSe ] :OBW:BANDwidth|BWIDth[:RESolution] <freq>`

`[ :SENSe ] :OBW:BANDwidth|BWIDth[:RESolution] ?`

Set the resolution bandwidth that will be used.

Factory Preset: 30.0 kHz

Range: 1.0 kHz to 1.0 MHz

Default Unit: Hz

Remarks: You must be in the cdma2000, W-CDMA, or 1xEV-DO mode to use this command. Use INSTRument:SElect to set the mode.

### Occupied Bandwidth—FFT Window

`[ :SENSe ] :OBW:FFT:WINDow[:TYPE]`

BH4Tap | BLACKman | FLATtop | GAUSSian | HAMMING | HANNing | KB70 | KB90 | KB110 | UNIFORM

`[ :SENSe ] :OBW:FFT:WINDow[:TYPE] ?`

Select the FFT window type.

BH4Tap - Blackman Harris with 4 taps

BLACKman - Blackman

FLATtop - flat top, set to the default (for high amplitude accuracy)

GAUSSian - Gaussian with alpha of 3.5

HAMMING - Hamming

HANNing - Hanning

KB70, 90, and 110 - Kaiser Bessel with sidelobes at -70, -90, or -110 dBc

UNIFORM - no window is used. (This is the unity response.)

Factory Preset: GAUSSian

Remarks: You must be in the cdma2000, W-CDMA, or 1xEV-DO mode to use this command. Use INSTRUMENT:SElect to set the mode.

### Occupied Bandwidth—Span

[ :SENSE ] :OBW:FREQUENCY:SPAN <freq>

[ :SENSE ] :OBW:FREQUENCY:SPAN?

Set the occupied bandwidth span. The analyzer span will retain this value throughout the measurement.

Factory Preset: 10.0 MHz

3.75 MHz for cdma2000, 1xEV-DO

Range: 10.0 kHz to 10.0 MHz

Default Unit: Hz

Remarks: You must be in the PDC, cdma2000, W-CDMA, or 1xEV-DO mode to use this command. Use INSTRUMENT:SElect to set the mode.

### Occupied Bandwidth—Trigger Source

*PDC mode*

[ :SENSE ] :OBW:TRIGGER:SOURCE

EXTERNAL [1] | EXTERNAL2 | IF | IMMEDIATE | RFBURST

[ :SENSE ] :OBW:TRIGGER:SOURCE?

*cdma2000, W-CDMA, 1xEV-DO mode*

[ :SENSE ] :OBW:TRIGGER:SOURCE

EXTERNAL [1] | EXTERNAL2 | FRAME | IF | IMMEDIATE | LINE | RFBURST

[ :SENSE ] :OBW:TRIGGER:SOURCE?

Select one of the trigger sources used to control the data acquisitions for the occupied bandwidth measurement.

EXTernal1 – rear panel external trigger input

EXTernal2 – front panel external trigger input

FRAMe – internal frame trigger (cdma2000, W-CDMA, 1xEV-DO mode only)

IF – internal IF envelope (video) trigger

IMMEDIATE – the next data acquisition is immediately taken, capturing the signal asynchronously (also called free run)

LINE – power line (cdma2000, W-CDMA, 1xEV-DO mode only)

RFBurst – wideband RF burst envelope trigger that has automatic level control for periodic burst signals

Factory Preset: IMMEDIATE for BS in PDC, cdma2000, W-CDMA, 1xEV-DO mode

RFBurst for MS in PDC mode

Remarks: You must be in the PDC, cdmaOne, cdma2000, W-CDMA, or 1xEV-DO mode to use this command. Use INSTRUMENT:SElect to set the mode.

## RF Power Commands

### RF Port Input Attenuation

```
[ :SENSE ] :POWER [ :RF ] :ATTenuation <rel_power>
```

```
[ :SENSE ] :POWER [ :RF ] :ATTenuation?
```

Set the RF input attenuator. This value is set at its auto value if RF input attenuation is set to auto.

Factory Preset: 0 dB

Range: 0 to 40 dB

Default Unit: dB

Front Panel

Access: **Input, Input Atten**

### Internal RF Preamplifier Control

```
[ :SENSE ] :POWER [ :RF ] :GAIN [ :STATE ] OFF | ON | 0 | 1
```

```
[ :SENSE ] :POWER [ :RF ] :GAIN [ :STATE ] ?
```

Turns the internal preamp on or off for the currently selected measurement. Requires Option 1DS.

Factory Preset: OFF

Front Panel

Access: **Input/Output, More (1 of 2), Int Preamp for Optional Personalities.**  
AMPLITUDE/Y Scale, More (1 of 3), Int Preamp for SA mode

Remarks: You must be in W-CDMA, cdma2000, or 1xEV-DO mode to use this command. Use INSTRUMENT:SELEct to set the mode. BEFORE you can turn on the preamp using the :SENSE command, you must also send the following command- :CONFigure:RHO | EVMQpsk | CDPower.

### Internal RF Preamplifier Attenuation

```
[ :SENSE ] :POWER [ :RF ] :GAIN:ATTenuation <rel_power>
```

```
[ :SENSE ] :POWER [ :RF ] :GAIN:ATTenuation?
```

Specifies the internal mechanical attenuator setting when the internal preamp is on. Requires Option 1DS. This not the same attenuator used when the preamp is OFF.

Factory Preset: 0 [dB]

Front Panel

Access: **Input/Output, More (1 of 2), Int Preamp for Optional Personalities.**  
AMPLITUDE/Y Scale, More (1 of 3), Int Preamp for SA mode

Range: 0,10, or 20 [dB]  
Other numbers between 0 and 20 are rounded to the nearest number; entries between numbers are rounded up. Entries above 20 are rounded down to 20.

Remarks: You must be in W-CDMA, cdma2000, or 1xEV-DO mode with the preamp ON to use this command. Use INSTRUMENT:SElect to set the mode. BEFORE you can turn on the preamp using the :SENSe command, you must also send the following command- :CONFigure:RHO | EVMQpsk | CDPower.

Key Path: Input/Output, More (1 of 2), Attenuation

State Saved: Saved in Instrument State

**RF Port Power Range Auto**

[ :SENSe ] :POWer [ :RF ] :RANGe :AUTO OFF | ON | 0 | 1

[ :SENSe ] :POWer [ :RF ] :RANGe :AUTO?

Select the RF port power range to be set either automatically or manually.

ON - power range is automatically set as determined by the actual measured power level at the start of a measurement.

OFF - power range is manually set

Factory Preset: ON

Remarks: You must be in the cdmaOne, GSM, EDGE, NADC, PDC, cdma2000, W-CDMA, mode to use this command. Use INSTRUMENT:SElect to set the mode.

Front Panel

Access: **Input, Max Total Pwr (at UUT)**

**RF Port Power Range Maximum Total Power**

[ :SENSe ] :POWer [ :RF ] :RANGe [ :UPPer ] <power>

[ :SENSe ] :POWer [ :RF ] :RANGe [ :UPPer ] ?

Set the maximum expected total power level at the radio unit under test. This value is ignored if RF port power range is set to auto.

External attenuation required above 30 dBm.

Factory Preset: -15.0 dBm

Range: -100.0 to 80.0 dBm for EDGE, GSM  
 -100.0 to 27.7 dBm for cdmaOne  
 -200.0 to 50.0 dBm for NADC, PDC  
 -200.0 to 100.0 dBm for cdma2000, W-CDMA

Default Unit: dBm

Remarks: Global to the current mode. This is coupled to the RF input attenuation

You must be in the cdmaOne, GSM, EDGE, NADC, PDC, cdma2000, W-CDMA mode to use this command. Use INSTRUMENT:SElect to set the mode.

Front Panel

Access: **Input, Max Total Pwr (at UUT)**

## Power Statistics CCDF Measurement

Commands for querying the statistical power measurement of the complementary cumulative distribution function (CCDF) measurement results and for setting to the default values are found in the “[MEASURE Group of Commands](#)” on page 318. The equivalent front panel keys for the parameters described in the following commands, are found under the **Meas Setup** key, after the **Power Stat CCDF** measurement has been selected from the **MEASURE** key menu.

### Power Statistics CCDF—Channel Bandwidth

```
[ :SENSE ] :PStatistic:BANDwidth|BWIDth <freq>
```

```
[ :SENSE ] :PStatistic:BANDwidth|BWIDth?
```

Enter a frequency value to set the channel bandwidth that will be used for data acquisition.

Factory Preset: 5.0 MHz

Range: 10.0 kHz to 6.7 MHz

Default Unit: Hz

Remarks: You must be in the cdma2000, W-CDMA, or 1xEV-DO mode to use this command. Use INSTRUMENT:SElect to set the mode.

### Power Statistics CCDF—Sample Counts

```
[ :SENSe ] :PStatIstIc:COUNTs <integer>
```

```
[ :SENSe ] :PStatIstIc:COUNTs?
```

Enter a value to set the sample counts. Measurement stops when the sample counts reach this value.

Factory Preset: 10,000,000

Range: 1,000 to 2,000,000,000

Unit: counts

Remarks: You must be in the cdma2000, W-CDMA, or 1xEV-DO mode to use this command. Use INSTRUMENT:SELEct to set the mode.

### Power Statistics CCDF—Sweep Time

```
[ :SENSe ] :PStatIstIc:SWEEp:TIME <time>
```

```
[ :SENSe ] :PStatIstIc:SWEEp:TIME?
```

Enter a value to set the measurement interval that will be used to make measurements.

Factory Preset: 1.0 ms

Range: 0.1 ms to 10 ms

Remarks: You must be in the cdma2000, W-CDMA, or 1xEV-DO mode to use this command. Use INSTRUMENT:SELEct to set the mode.

### Power Statistics CCDF—Trigger Source

```
[ :SENSe ] :PStatIstIc:TRIGger:SOURce
```

```
EXTErnal [1] | EXTErnal2 | FRAME | IF | IMMEDIATE | RFBURst
```

```
[ :SENSe ] :PStatIstIc:TRIGger:SOURce?
```

Select one of the trigger sources used to control the data acquisitions.

EXTErnal 1 - front panel external trigger input

EXTErnal 2 - rear panel external trigger input

FRAME - uses the internal frame timer, which has been synchronized to the selected burst sync.

IF - internal IF envelope (video) trigger

IMMEDIATE - the next data acquisition is immediately taken, capturing the signal asynchronously (also called Free Run).



RFBurst - wideband RF burst envelope trigger that has automatic level control for periodic burst signals.

Factory Preset: IMMEDIATE

Remarks: You must be in the cdma2000, W-CDMA, or 1xEV-DO mode to use this command. Use INSTRUMENT:SELECT to set the mode.

## Radio Standards Commands

### Radio Device Under Test

```
[[:SENSe]:RADIo:DEVIce BTS|MS
```

```
[[:SENSe]:RADIo:DEVIce?
```

Select the type of radio device to be tested.

BTS - Base station transmitter test

MS - Mobile station transmitter test

Factory Preset: BTS

Remarks: Global to the current mode.

You must be in cdma2000, GSM, EDGE, W-CDMA mode to use this command. Use INSTRument:SELEct to set the mode.

Front Panel

Access: **Mode Setup, Radio, Device**

## Modulation Accuracy (Rho) Measurement

Commands for querying the rho measurement results and for setting to the default values are found in the “MEASure Group of Commands” on page 318. The equivalent front panel keys for the parameters described in the following commands, are found under the **Meas Setup** key, after the **Mod Accuracy (Rho)** or **Mod Accuracy (Composite Rho)** measurement has been selected from the **MEASURE** key menu.

### Modulation Accuracy (Rho)—Average Count

```
[ :SENSE ] :RHO:AVERAge:COUNT <integer>
```

```
[ :SENSe ] :RHO:AVERAge:COUNT?
```

Set the number of data acquisitions that will be averaged. After the specified number of averaging counts, the averaging mode (termination control) setting determines the averaging action.

Factory Preset: 10

Range: 1 to 10,000

Remarks: You must be in the cdmaOne, cdma2000, W-CDMA, or 1xEV-DO mode to use this command. Use INSTRument:SELEct to set the mode.

### Modulation Accuracy (Rho)—Averaging State

```
[ :SENSE ] :RHO:AVERAge [:STATe] OFF | ON | 0 | 1
```

```
[ :SENSe ] :RHO:AVERAge [:STATe] ?
```

Turn the modulation accuracy averaging function on or off.

Factory Preset: OFF

ON for cdma2000, W-CDMA, 1xEV-DO

Remarks: You must be in the cdmaOne, cdma2000, W-CDMA, or 1xEV-DO mode to use this command. Use INSTRument:SELEct to set the mode.

### Modulation Accuracy (Rho)—Averaging Termination Control

```
[ :SENSE ] :RHO:AVERAge:TCONtrol EXPonential | REPEat
```

```
[ :SENSe ] :RHO:AVERAge:TCONtrol?
```

Select the type of termination control used for the averaging function. This determines the averaging action after the specified number of frames (average count) is reached.

EXPonential - Each successive data acquisition after the average

count is reached, is exponentially weighted and combined with the existing average.

REPeat - After reaching the average count, the averaging is reset and a new average is started.

Factory Preset: REPeat for cdmaOne, cdma2000, W-CDMA, 1xEV-DO

Remarks: You must be in the cdmaOne, cdma2000, W-CDMA, or 1xEV-DO mode to use this command. Use INSTRument:SElect to set the mode.

### Modulation Accuracy (Rho)—Chip Rate

`[ :SENSe ] :RHO:CRATe <freq>`

`[ :SENSe ] :RHO:CRATe?`

Enter a frequency value to set the chip rate.

Factory Preset: 1.2288 MHz for cdma2000, 1xEV-DO

3.84 MHz for W-CDMA

Range: 1.10592 to 1.35168 MHz for cdma2000, 1xEV-DO

3.456 to 4.224 MHz for W-CDMA

Default Unit: Hz

Remarks: You must be in the cdma2000, W-CDMA, or 1xEV-DO mode to use this command. Use INSTRument:SElect to set the mode.

### Modulation Accuracy (Rho)—Multi Carrier Estimator

`[ :SENSe ] :RHO:MCEStimator OFF|ON|0|1`

`[ :SENSe ] :RHO:MCEStimator?`

Turns the multi carrier estimator on or off.

OFF - computes the phase information only from one coded signal assuming that each code phase is perfectly aligned.

ON - aligns the code phases to be orthogonal before computing the phase information.

Factory Preset: OFF

Remarks: You must be in the cdma2000, W-CDMA, or 1xEV-DO mode to use this command. Use INSTRument:SElect to set the mode.

### Modulation Accuracy (Rho)—Spectrum Normal/Invert

```
[ :SENSE ] :RHO:SPECTrum INVert | NORMAl
```

```
[ :SENSE ] :RHO:SPECTrum?
```

Set a spectrum either to normal or inverted for the demodulation related measurements. If set to INVert, the upper and lower spectrums are swapped.

Factory Preset: NORMAl

Remarks        You must be in the cdmaOne, cdma2000, W-CDMA, or 1xEV-DO mode to use this command. Use INSTRument:SElect to set the mode.

### Modulation Accuracy (Rho)—Long Code Mask

```
[ :SENSE ] :RHO:SYNC:LCMask <integer>
```

```
[ :SENSE ] :RHO:SYNC:LCMask?
```

Set the long code mask for MS measurement.

Factory Preset: 2,199,023,255,552 (20,000,000,000h)

Range:            0 to 4,398,046,511,103 (0h to 3F,FFF,FFF,FFFh)

Remarks:        You must be in the cdma2000 mode to use this command. Use INSTRument:SElect to set the mode.

### Modulation Accuracy (Rho)—Trigger Source

```
[ :SENSE ] :RHO:TRIGger:SOURce
```

```
EXTErnal [1] | EXTErnal2 | FRAMe | IF | IMMEDIATE | RFBURSt
```

```
[ :SENSE ] :RHO:TRIGger:SOURce?
```

Select the trigger source used to control the data acquisitions.

EXTErnal 1 – front panel external trigger input

EXTErnal 2 – rear panel external trigger input

FRAMe – internal frame trigger

IF – internal IF envelope (video) trigger

IMMEDIATE – the next data acquisition is immediately taken, capturing the signal asynchronously (also called free run).

RFBURSt – internal wideband RF burst envelope trigger that has automatic level control for periodic burst signals.

Programming Commands  
**SENSe Subsystem**

Factory Preset: IMMEDIATE

Remarks: You must be in the cdmaOne, cdma2000, W-CDMA, or 1xEV-DO mode to use this command. Use INSTRUMENT:SELECT to set the mode.

Front Panel

Access: **Meas Setup, Trig Source**

## Spectrum Emission Mask Measurement

Commands for querying the Spectrum Emission Mask measurement results and for setting to the default values are found in the “MEASure Group of Commands” on page 318. The equivalent front panel keys for the parameters described in the following commands, are found under the **Meas Setup** key, after selecting the measurement from the **MEASURE** key menu. Select the **Spectrum Emission Mask** measurement (for W-CDMA, cdma2000) or the **Spurious Emissions and ACP** measurement (for 1xEV-DO).

### Spectrum Emission Mask—Average Count

```
[ :SENSe ] :SEMAsk:AVERAge:COUNT <integer>
```

```
[ :SENSe ] :SEMAsk:AVERAge:COUNT?
```

Set the number of data acquisitions that will be averaged. After the specified number of average count, the average mode (termination control) setting determines the average action.

Factory Preset: 10

Range: 1 to 10,000

Remarks: You must be in the cdma2000, W-CDMA, or 1xEV-DO mode to use this command. Use INSTRument:SElect to set the mode.

### Spectrum Emission Mask—Averaging State

```
[ :SENSe ] :SEMAsk:AVERAge [:STATe] OFF | ON | 0 | 1
```

```
[ :SENSe ] :SEMAsk:AVERAge [:STATe] ?
```

Turn the averaging function On or Off.

Factory Preset: OFF

Remarks: You must be in the cdma2000, W-CDMA, or 1xEV-DO mode to use this command. Use INSTRument:SElect to set the mode.

### Spectrum Emission Mask—Reference Channel Integration Bandwidth

*cdma2000, W-CDMA mode*

```
[ :SENSe ] :SEMAsk:BANDwidth [n] | BWIDth [n] :INTEgration <freq>
```

```
[ :SENSe ] :SEMAsk:BANDwidth [n] | BWIDth [n] :INTEgration?
```

*1xEV-DO mode*

```
[[:SENSe]:SEMask:BANDwidth|BWIDth:INTEgration[m] <freq>
```

```
[[:SENSe]:SEMask:BANDwidth|BWIDth:INTEgration[m] ?
```

Set the integration bandwidth that will be used for the reference channel.

BANDwidth[n] | BWIDth[n]

n=1 is the base station test and n=2 is the mobile station test. The default is the base station test (1). (cdma2000, W-CDMA mode only)

INTEgration[m] m=1 is the spectrum emission mask (SEM) mode and m=2 is the adjacent channel power (ACP) mode. The default is the SEM mode (1). (1xEV-DO mode only)

Factory Preset: 1.23 MHz for cdma2000, 1xEV-DO  
3.84 MHz for W-CDMA

Range: 100.0 kHz to 1.250 MHz

Default Unit: Hz

Remarks: You must be in the cdma2000, W-CDMA, or 1xEV-DO mode to use this command. Use INSTRument:SElect to set the mode.

### Spectrum Emission Mask—Reference Channel Resolution Bandwidth

*cdma2000, W-CDMA mode*

```
[[:SENSe]:SEMask:BANDwidth[n] | BWIDth[n]:RESolution <freq>
```

```
[[:SENSe]:SEMask:BANDwidth[n] | BWIDth[n]:RESolution?
```

*1xEV-DO mode*

```
[[:SENSe]:SEMask:BANDwidth|BWIDth:RESolution[m] <freq>
```

```
[[:SENSe]:SEMask:BANDwidth|BWIDth:RESolution[m] ?
```

Set the resolution bandwidth for the reference channel.

BANDwidth[n] | BWIDth[n]

n=1 is the base station test and n=2 is the mobile station test. The default is the base station test (1). (cdma2000, W-CDMA mode only)

RESolution[m] m=1 is the spectrum emission mask (SEM) mode and m=2 is the adjacent channel power (ACP) mode. The default is the SEM mode (1). (1xEV-DO mode only)

Factory Preset: No valid value as the default is set to Auto. See [:SENS]:SEM:BAND[n] | BWID[n]:RES[m]:AUTO.



Range: 1.0 kHz to 7.5 MHz  
 Default Unit: Hz  
 Remarks: You must be in the cdma2000, W-CDMA, or 1xEV-DO mode to use this command. Use INSTRUMENT:SElect to set the mode.

### Spectrum Emission Mask—Auto Mode for Reference Channel Resolution Bandwidth

*cdma2000, W-CDMA mode*

```
[ :SENSe ] :SEMask:BANDwidth [n] | BWIDth [n] :RESolution:AUTO  
OFF | ON | 0 | 1
```

```
[ :SENSe ] :SEMask:BANDwidth [n] | BWIDth [n] :RESolution:AUTO?
```

*1xEV-DO mode*

```
[ :SENSe ] :SEMask:BANDwidth | BWIDth:RESolution [m] :AUTO  
OFF | ON | 0 | 1
```

```
[ :SENSe ] :SEMask:BANDwidth | BWIDth:RESolution [m] :AUTO?
```

Set the auto mode to determine the resolution bandwidth to On or Off. If set to Off, enter a frequency value referring to [:SENS]:SEM:BAND[n] | BWID[n]:RES[m].

BANDwidth[n] | BWIDth[n]

n=1 is the base station test and n=2 is the mobile station test. The default is the base station test (1). (cdma2000, W-CDMA mode only)

RESolution[m] m=1 is the spectrum emission mask (SEM) mode and m=2 is the adjacent channel power (ACP) mode. The default is the SEM mode (1). (1xEV-DO mode only)

Factory Preset: ON

Remarks: You must be in the cdma2000, W-CDMA, or 1xEV-DO mode to use this command. Use INSTRUMENT:SElect to set the mode.

### Spectrum Emission Mask—Detector Mode

```
[ :SENSe ] :SEMask:DETEctor [ :FUNction ] AAverage | POSitive
```

```
[ :SENSe ] :SEMask:DETEctor [ :FUNction ] ?
```

Select one of the detector modes for spectrum measurements.

AAverage (absolute average) - the absolute average power in each frequency is measured across the spectrum

POSitive - the positive peak power in each frequency is measured across the spectrum

Factory Preset: AAVerage (absolute average)

Remarks: You must be in the cdma2000, W-CDMA, or 1xEV-DO mode to use this command. Use INSTRument:SElect to set the mode.

### Spectrum Emission Mask—Channel Frequency Span

[[:SENSe]:SEMAsk:FREQuency[n]:SPAN[m] <freq>

[[:SENSe]:SEMAsk:FREQuency[n]:SPAN[m] ?

Enter a frequency value to set the channel frequency span for the reference channel integration.

FREQuency[n] n=1 is the base station test and n=2 is the mobile test. The default is the base station test (1). (cdma2000, W-CDMA mode only)

SPAN[m] m=1 is the spectrum emission mask (SEM) mode and m=2 is the adjacent channel power (ACP) mode. The default is the SEM mode (1). (1xEV-DO mode only)

Factory Preset: 1.25 MHz for cdma2000, 1xEV-DO

5.0 MHz for W-CDMA

Range: 100.0 kHz to 10.0 MHz

Remarks: You must be in the cdma2000, W-CDMA, or 1xEV-DO mode to use this command. Use INSTRument:SElect to set the mode.

### Spectrum Emission Mask—Reference Channel Step Frequency

*cdma2000, W-CDMA mode*

[[:SENSe]:SEMAsk:FREQuency[n]:STEP <freq>

[[:SENSe]:SEMAsk:FREQuency[n]:STEP?

*1xEV-DO mode*

[[:SENSe]:SEMAsk:FREQuency:STEP[m] <freq>

[[:SENSe]:SEMAsk:FREQuency:STEP[m] ?

Enter a frequency value to set the step frequency for the reference channel integration.

FREQuency[n] n=1 is the base station test and n=2 is the mobile test. The default is the base station test (1). (cdma2000,

W-CDMA mode only)

STEP[m] m=1 is the spectrum emission mask (SEM) mode and m=2 is the adjacent channel power (ACP) mode. The default is the SEM mode (1). (1xEV-DO mode only)

Factory Preset: No valid value as the default is set to Auto. See [:SENSE]:SEM:FREQ[n]:STEP[m]:AUTO.

Range: 100 Hz to 7.5 MHz

Remarks: You must be in the cdma2000, W-CDMA, or 1xEV-DO mode to use this command. Use INSTRUMENT:SElect to set the mode.

### Spectrum Emission Mask—Auto Mode for Reference Channel Step Frequency

*cdma2000, W-CDMA mode*

[:SENSE]:SEMmask:FREQUENCY [n]:STEP:AUTO OFF|ON|0|1

[:SENSE]:SEMmask:FREQUENCY [n]:STEP:AUTO?

*1xEV-DO mode*

[:SENSE]:SEMmask:FREQUENCY:STEP [m]:AUTO OFF|ON|0|1

[:SENSE]:SEMmask:FREQUENCY:STEP [m]:AUTO?

Set the auto mode to determine the step frequency to On or Off.

OFF - enter a value to set the step frequency for the reference channel integration, referring to [:SENSE]:SEM:FREQ[n]:STEP[m].

ON - the step frequency for the reference channel integration is set to a half of the resolution bandwidth.

FREQUENCY[n] n=1 is the base station test and n=2 is the mobile test. The default is the base station test (1). (cdma2000, W-CDMA mode only)

STEP[m] m=1 is the spectrum emission mask (SEM) mode and m=2 is the adjacent channel power (ACP) mode. The default is the SEM mode (1). (1xEV-DO mode only)

Factory Preset: ON

Remarks: You must be in the cdma2000, W-CDMA, or 1xEV-DO mode to use this command. Use INSTRUMENT:SElect to set the mode.

### Spectrum Emission Mask—Offset Resolution Bandwidth

*cdma2000, W-CDMA mode*

```
[[:SENSe]:SEMAsk:OFFSet [n]:LIST:BANDwidth|BWIDth  
<res_bw>,<res_bw>,<res_bw>,<res_bw>,<res_bw>
```

```
[[:SENSe]:SEMAsk:OFFSet [n]:LIST:BANDwidth|BWIDth?
```

*1xEV-DO mode*

```
[[:SENSe]:SEMAsk:OFFSet:LIST [m]:BANDwidth|BWIDth  
<res_bw>,<res_bw>,<res_bw>,<res_bw>,<res_bw>
```

```
[[:SENSe]:SEMAsk:OFFSet:LIST [m]:BANDwidth|BWIDth?
```

Define the offset resolution bandwidth for Spectrum Emission Mask measurements. The list must contain five (5) entries. You can turn off (not use) specific offsets with [:SENS]:SEM:OFFS[n]:LIST[m]:STAT.

OFFSet[n]      n=1 is the base station test and n=2 is the mobile test. The default is the base station test (1). (cdma2000, W-CDMA only)

LIST[m]        m=1 is the spectrum emission mask (SEM) mode and m=2 is the adjacent channel power (ACP) mode. The default is the SEM mode (1). (1xEV-DO mode only)

Factory Preset:

Mode	Variant	Offset A	Offset B	Offset C	Offset D	Offset E
<b>cdma2000</b>	BTS	3.00 kHz	30.00 kHz	30.0 kHz	6.25 kHz	1.000 MHz
	MS	30.00 kHz	30.00 kHz	6.25 kHz	1.000 MHz	1.000 MHz
<b>W-CDMA</b>	BTS	30.00 kHz	30.00 kHz	30.00 kHz	50.00 kHz	1.000 MHz
	MS	30.00 kHz	1.000 MHz	1.000 MHz	1.000 MHz	1.000 MHz
<b>1xEV-DO</b>	SEM	3.000 kHz	30.00 kHz	30.00 kHz	6.250 kHz	1.000 MHz
	ACP	3.000 kHz	3.000 kHz	30.00 kHz	30.00 kHz	30.00 kHz

Range:            300 Hz to 7.5 MHz

Default Unit:    Hz

Remarks:        You must be in the cdma2000, W-CDMA, or 1xEV-DO mode to use this command. Use INSTRument:SElect to set the mode.

### Spectrum Emission Mask—Auto Offset Resolution Bandwidth

*cdma2000, W-CDMA mode*

```
[ :SENSE ] :SEMAsk:OFFSet [n] :LIST:BAWdwidth | BWIDth:AUTO  
OFF | ON | 0 | 1, OFF | ON | 0 | 1, OFF | ON | 0 | 1, OFF | ON | 0 | 1, OFF | ON | 0 | 1
```

```
[ :SENSe ] :SEMAsk:OFFSet [n] :LIST:BAWdwidth | BWIDth:AUTO?
```

*1xEV-DO mode*

```
[ :SENSe ] :SEMAsk:OFFSet:LIST [m] :BAWdwidth | BWIDth:AUTO  
OFF | ON | 0 | 1, OFF | ON | 0 | 1, OFF | ON | 0 | 1, OFF | ON | 0 | 1, OFF | ON | 0 | 1
```

```
[ :SENSe ] :SEMAsk:OFFSet:LIST [m] :BAWdwidth | BWIDth:AUTO?
```

Set the auto mode to determine the offset resolution bandwidth to On or Off.

OFF - enter a value to set the resolution bandwidth for an offset channel, referring to [:SENS]:SEM:OFFS[n]:LIST[m]BAND | BWID.

ON - the resolution bandwidth for an offset channel is automatically set according to the offset start and stop frequencies.

OFFSet[n]      n=1 is the base station test and n=2 is the mobile test. The default is the base station test (1). (cdma2000, W-CDMA mode only)

LIST[m]        m=1 is the spectrum emission mask (SEM) mode and m=2 is the adjacent channel power (ACP) mode. The default is the SEM mode (1). (1xEV-DO mode only)

Factory Preset and \*RST:

Mode	Variant	Offset A	Offset B	Offset C	Offset D	Offset E
cdma2000		OFF	OFF	OFF	OFF	OFF
W-CDMA		OFF	OFF	OFF	OFF	OFF
1xEV-DO	SEM	OFF	OFF	OFF	OFF	OFF
	ACP	OFF	OFF	OFF	OFF	OFF

Remarks:      You must be in the cdma2000, W-CDMA, or 1xEV-DO mode to use this command. Use INSTRument:SElect to set the mode.

### Spectrum Emission Mask—Offset Resolution Bandwidth Multiplier

*cdma2000, W-CDMA mode*

```
[ :SENSe ] :SEMAsk:OFFSet [n] :LIST:BAWdwidth | BWIDth:IMULti  
<integer>, <integer>, <integer>, <integer>, <integer>
```

```
[ :SENSe ] :SEMAsk:OFFSet [n] :LIST:BAWdwidth | BWIDth:IMULti?
```

*1xEV-DO mode*

`[ :SENSe ] :SEMAsk:OFFSet:LIST [m] :BANDwidth | BWIDth:IMULti  
<integer>, <integer>, <integer>, <integer>, <integer>`

`[ :SENSe ] :SEMAsk:OFFSet:LIST [m] :BANDwidth | BWIDth:IMULti?`

Specify a multiplier of the offset resolution bandwidth for the offset measurement integration bandwidth.

OFFSet[n]      n=1 is the base station test and n=2 is the mobile test. The default is the base station test (1). (cdma2000, W-CDMA mode only)

LIST[m]        m=1 is the spectrum emission mask (SEM) mode and m=2 is the adjacent channel power (ACP) mode. The default is the SEM mode (1). (1xEV-DO mode only)

Factory Preset:

Mode	Variant	Offset A	Offset B	Offset C	Offset D	Offset E
cdma2000	BTS	10	1	1	1	1
	MS	1	1	1	1	1
W-CDMA	BTS	1	1	1	20	1
	MS	1	1	1	1	1
1xEV-DO	SEM	10	1	1	1	1
	ACP	1	1	1	1	1

Range:            1 to ((Stop frequency – Start frequency) / Resolution bandwidth)

Remarks:        You must be in the cdma2000, W-CDMA, or 1xEV-DO mode to use this command. Use INSTRument:SElect to set the mode.

**Spectrum Emission Mask—Offset Start Frequency**

*cdma2000, W-CDMA mode*

`[ :SENSe ] :SEMAsk:OFFSet [n] :LIST:FREQuency:START  
<f_offset>, <f_offset>, <f_offset>, <f_offset>, <f_offset>`

`[ :SENSe ] :SEMAsk:OFFSet [n] :LIST:FREQuency:START?`

*1xEV-DO mode*

`[ :SENSe ] :SEMAsk:OFFSet:LIST [m] :FREQuency:START  
<f_offset>, <f_offset>, <f_offset>, <f_offset>, <f_offset>`

`[ :SENSe ] :SEMAsk:OFFSet:LIST [m] :FREQuency:START?`

Set the five (5) sets of the offset start frequencies.

OFFSet[n] n=1 is the base station test and n=2 is the mobile test.  
The default is the base station test (1). (cdma2000, W-CDMA mode only)

LIST[m] m=1 is the spectrum emission mask (SEM) mode and m=2 is the adjacent channel power (ACP) mode. The default is the SEM mode (1). (1xEV-DO mode only)

Factory Preset:

Mode	Variant	Offset A	Offset B	Offset C	Offset D	Offset E
cdma2000	BTS	765.0 kHz	795.0 kHz	1.195 MHz	3.2531 MHz	7.500 MHz
	MS	900.0 kHz	1.995 MHz	2.2531 MHz	8.500 MHz	12.50 MHz
W-CDMA	BTS	2.515 MHz	2.715 MHz	3.515 MHz	4.000 MHz	8.000 MHz
	MS	2.515 MHz	4.000 MHz	7.500 MHz	8.5 00MHz	12.50 MHz
1xEV-DO	SEM	765.0 kHz	795.0 kHz	1.995 MHz	3.2531 MHz	7.500 MHz
	ACP	735.0 kHz	1.965 MHz	3.125 MHz	4.000 MHz	7.500 MHz

Range: 10.0 kHz to 100.0 MHz

Default Unit: Hz

Remarks: You must be in the cdma2000, W-CDMA, or 1xEV-DO mode to use this command. Use INSTRument:SElect to set the mode.

### Spectrum Emission Mask—Offset Step Frequency

*cdma2000, W-CDMA mode*

```
[ :SENSe] :SEMAsk:OFFSet [n] :LIST:FREQuency:STEP
<f_offset>,<f_offset>,<f_offset>,<f_offset>,<f_offset>
```

```
[ :SENSe] :SEMAsk:OFFSet [n] :LIST:FREQuency:STEP?
```

*1xEV-DO mode*

```
[ :SENSe] :SEMAsk:OFFSet:LIST [m] :FREQuency:STEP
<f_offset>,<f_offset>,<f_offset>,<f_offset>,<f_offset>
```

```
[ :SENSe] :SEMAsk:OFFSet:LIST [m] :FREQuency:STEP?
```

Set the five (5) sets of the offset step frequencies.

OFFSet[n] n=1 is the base station test and n=2 is the mobile test.

The default is the base station test (1). (cdma2000, W-CDMA mode only)

LIST[m] m=1 is the spectrum emission mask (SEM) mode and m=2 is the adjacent channel power (ACP) mode. The default is the SEM mode (1). (1xEV-DO mode only)

Factory Preset: No valid value as the default is set to Auto. See [:SENS]:SEM:OFF[n]:LIST[m]:FREQ:STEP:AUTO.

Range: 100 Hz to 7.5 MHz

The minimum value is determined to be equal to or greater than one 2000th (1/2000) of the frequency difference derived from (Stop Freq – Start Freq).

Default Unit: Hz

Remarks: You must be in the cdma2000, W-CDMA, or 1xEV-DO mode to use this command. Use INSTRument:SElect to set the mode.

### Spectrum Emission Mask—Auto Offset Step Frequency

*cdma2000, W-CDMA mode*

```
[:SENSe]:SEMAsk:OFFSet [n]:LIST:FREQuency:STEP:AUTO  
OFF|ON|0|1, OFF|ON|0|1, OFF|ON|0|1, OFF|ON|0|1, OFF|ON|0|1
```

```
[:SENSe]:SEMAsk:OFFSet [n]:LIST:FREQuency:STEP:AUTO?
```

*1xEV-DO mode*

```
[:SENSe]:SEMAsk:OFFSet:LIST [m]:FREQuency:STEP:AUTO  
OFF|ON|0|1, OFF|ON|0|1, OFF|ON|0|1, OFF|ON|0|1, OFF|ON|0|1
```

```
[:SENSe]:SEMAsk:OFFSet:LIST [m]:FREQuency:STEP:AUTO?
```

Set the auto mode to determine the offset step frequency to On or Off.

OFF - enter a value to set the step frequency for an offset channel, referring to [:SENS]:SEM:OFFS[n]:LIST[m]:FREQ:STEP.

ON - the step frequency for an offset channel is automatically set according to the offset start and stop frequencies.

OFFSet[n] n=1 is the base station test and n=2 is the mobile test. The default is the base station test (1). (cdma2000, W-CDMA mode only)

LIST[m] m=1 is the spectrum emission mask (SEM) mode and m=2 is the adjacent channel power (ACP) mode. The default is the SEM mode (1). (1xEV-DO mode only)



Factory Preset:

Mode	Variant	Offset A	Offset B	Offset C	Offset D	Offset E
<b>cdma2000</b>		ON	ON	ON	ON	ON
<b>W-CDMA</b>		ON	ON	ON	ON	ON
<b>1xEV-DO</b>	SEM	ON	ON	ON	ON	ON
	ACP	ON	ON	ON	ON	ON

Remarks: You must be in cdma2000, W-CDMA, or 1xEV-DO mode to use this command. Use INSTRUMENT:SELEct to set the mode.

### Spectrum Emission Mask—Offset Stop Frequency

*cdma2000, W-CDMA mode*

```
[ :SENSE] :SEMask:OFFSet [n] :LIST:FREQuency:STOP
<f_offset>,<f_offset>,<f_offset>,<f_offset>,<f_offset>
```

```
[ :SENSe] :SEMask:OFFSet [n] :LIST:FREQuency:STOP?
```

*1xEV-DO mode*

```
[ :SENSE] :SEMask:OFFSet:LIST [m] :FREQuency:STOP
<f_offset>,<f_offset>,<f_offset>,<f_offset>,<f_offset>
```

```
[ :SENSe] :SEMask:OFFSet:LIST [m] :FREQuency:STOP?
```

Sets the five (5) sets of the offset stop frequencies.

OFFSet[n] n=1 is the base station test and n=2 is the mobile test. The default is the base station test (1). (cdma2000, W-CDMA mode only)

LIST[m] m=1 is the spectrum emission mask (SEM) mode and m=2 is the adjacent channel power (ACP) mode. The default is the SEM mode (1). (1xEV-DO mode only)

Factory Preset:

Mode	Variant	Offset A	Offset B	Offset C	Offset D	Offset E
<b>cdma2000</b>	BTS	795.0 kHz	1.195 MHz	4.015 MHz	4.0031 MHz	12.50 MHz
	MS	1.995 MHz	4.015 MHz	4.0031 MHz	12.00 MHz	15.00 MHz
<b>W-CDMA</b>	BTS	2.715 MHz	3.515 MHz	4.000 MHz	8.000 MHz	12.50 MHz
	MS	3.485 MHz	7.500 MHz	8.500 MHz	12.00 MHz	15.00 MHz

Mode	Variant	Offset A	Offset B	Offset C	Offset D	Offset E
1xEV-DO	SEM	795.0 kHz	1.995 MHz	4.015 MHz	4.0031 MHz	12.50 MHz
	ACP	765.0 kHz	1.995 MHz	3.125 MHz	4.000 MHz	7.500 MHz

Range: 10.0 kHz to 100.0 MHz

Default Unit: Hz

Remarks: You must be in the cdma2000, W-CDMA, or 1xEV-DO mode to use this command. Use INSTRument:SElect to set the mode.

### Spectrum Emission Mask—Offset Relative Attenuation

*cdma2000, W-CDMA mode*

```
[ :SENSe ] :SEMAsk:OFFSet [n] :LIST:RATTenuation
<rel_power>, <rel_power>, <rel_power>, <rel_power>, <rel_power>
```

```
[ :SENSe ] :SEMAsk:OFFSet [n] :LIST:RATTenuation?
```

*1xEV-DO mode*

```
[ :SENSe ] :SEMAsk:OFFSet:LIST [m] :RATTenuation
<rel_power>, <rel_power>, <rel_power>, <rel_power>, <rel_power>
```

```
[ :SENSe ] :SEMAsk:OFFSet:LIST [m] :RATTenuation?
```

Set a relative amount of attenuation for the measurements made at an offset channel. The amount is specified relative to the attenuation required to measure the carrier channel. Since the offset channel power is lower than the carrier channel power, less attenuation is required to measure the offset channel and you get wider dynamic range for the measurement.

You can turn off (not use) specific offset channels with  
[:SENS]:SEM:OFFS[n]:LIST[m]:STAT.

OFFSet[n]      n=1 is the base station test and n=2 is the mobile test. The default is the base station test (1). (cdma2000, W-CDMA mode only)

LIST[m]        m=1 is the spectrum emission mask (SEM) mode and m=2 is the adjacent channel power (ACP) mode. The default is the SEM mode (1). (1xEV-DO mode only)

Factory Preset:

Mode	Offset A	Offset B	Offset C	Offset D	Offset E
cdma2000	0.00 dB	0.00 dB	0.00 dB	0.00 dB	0.00 dB

Mode	Offset A	Offset B	Offset C	Offset D	Offset E
W-CDMA	0.00 dB	0.00 dB	0.00 dB	0.00 dB	0.00 dB
1xEV-DO	0.00 dB	0.00 dB	0.00 dB	0.00 dB	0.00 dB

Range: -40.00 to 0.00 dB, but this relative attenuation cannot exceed the absolute attenuation ranging from 0 to 40 dB.

Default Unit: dB

Remarks: Remember that the attenuation that you specify is always relative to the amount of attenuation used for the carrier channel. Selecting negative attenuation means that you want less attenuation used. For example, if the measurement must use 20 dB of attenuation for the carrier measurement and you want to use 12 dB less attenuation for the first offset, you would send the value -12 dB.

You must be in the cdma2000, W-CDMA, or 1xEV-DO mode to use this command. Use INSTRUMENT:SElect to set the mode.

### Spectrum Emission Mask—Offset Frequency Side

*cdma2000, W-CDMA mode*

```
[ :SENSe ] :SEMAsk:OFFSet [n] :LIST:SIDE BOTH | NEGative | POSitive,
BOTH | NEGative | POSitive, BOTH | NEGative | POSitive,
BOTH | NEGative | POSitive, BOTH | NEGative | POSitive
```

```
[ :SENSe ] :SEMAsk:OFFSet [n] :LIST:SIDE?
```

*1xEV-DO mode*

```
[ :SENSe ] :SEMAsk:OFFSet:LIST [m] :SIDE BOTH | NEGative | POSitive,
BOTH | NEGative | POSitive, BOTH | NEGative | POSitive,
BOTH | NEGative | POSitive, BOTH | NEGative | POSitive
```

```
[ :SENSe ] :SEMAsk:OFFSet:LIST [m] :SIDE?
```

Specify which sideband will be measured. You can turn off (not use) specific offsets with [:SENS]:SEM:OFFS[n]:LIST[m]:STAT.

BOTH - both of the negative (lower) and positive (upper) sidebands

NEGative - negative (lower) sideband only

POSitive - positive (upper) sideband only

OFFSet[n] n=1 is the base station test and n=2 is the mobile test. The default is the base station test (1). (cdma2000,

W-CDMA mode only)

LIST[m] m=1 is the spectrum emission mask (SEM) mode and m=2 is the adjacent channel power (ACP) mode. The default is the SEM mode (1). (1xEV-DO mode only)

Factory Preset:

Mode	Variant	Offset A	Offset B	Offset C	Offset D	Offset E
cdma2000		BOTH	BOTH	BOTH	BOTH	BOTH
W-CDMA		BOTH	BOTH	BOTH	BOTH	BOTH
1xEV-DO	SEM	BOTH	BOTH	BOTH	BOTH	BOTH
	ACP	BOTH	BOTH	BOTH	BOTH	BOTH

Remarks: You must be in the cdma2000, W-CDMA, or 1xEV-DO mode to use this command. Use INSTRument:SElect to set the mode.

### Spectrum Emission Mask—Offset Start Absolute Power Limit

*cdma2000, W-CDMA mode*

```
[ :SENSe ] :SEMAsk:OFFSet [n] :LIST:START:ABSolute
<abs_power>, <abs_power>, <abs_power>, <abs_power>, <abs_power>
```

```
[ :SENSe ] :SEMAsk:OFFSet [n] :LIST:START:ABSolute?
```

*1xEV-DO mode*

```
[ :SENSe ] :SEMAsk:OFFSet:LIST [m] :START:ABSolute
<abs_power>, <abs_power>, <abs_power>, <abs_power>, <abs_power>
```

```
[ :SENSe ] :SEMAsk:OFFSet:LIST [M] :START:ABSolute?
```

Sets an absolute power level for each offset start limit. The list must contain five (5) entries. If there is more than one offset, the offset closest to the carrier channel comes first in the list.

The fail condition for each offset channel is set by  
[:SENS]:SEM:OFFS[n]:LIST[m]:TEST.

You can turn off (not use) specific offset channels with  
[:SENS]:SEM:OFFS[n]:LIST[m]:STAT.

The query returns the five (5) sets of the real values currently set to the absolute power test limits.

OFFSet[n] n=1 is the base station test and n=2 is the mobile test. The default is the base station test (1). (cdma2000, W-CDMA mode only)

LIST[m]            m=1 is the spectrum emission mask (SEM) mode and  
                      m=2 is the adjacent channel power (ACP) mode. The  
                      default is the SEM mode (1). (1xEV-DO mode only)

Factory Preset:

Mode	Variant	Offset A	Offset B	Offset C	Offset D	Offset E
<b>cdma2000</b>	BTS	-27.0 dBm	-27.0 dBm	-27.0 dBm	-46.00 dBm	-13.00 dBm
	MS	-70.13 dBm	-70.13 dBm	-35.00 dBm	-13.00 dBm	-13.00 dBm
<b>W-CDMA</b>	BTS	-12.50 dBm	-12.50 dBm	-24.50 dBm	-11.50 dBm	-11.50 dBm
	MS	-69.57 dBm	-54.34 dBm	-54.34 dBm	-54.34 dBm	-54.34 dBm
<b>1xEV-DO</b>	SEM	-27.00 dBm	-27.00 dBm	-27.00 dBm	-46.00 dBm	-13.00 dBm
	ACP	-27.00 dBm	-27.00 dBm	-13.00 dBm	-13.00 dBm	-13.00 dBm

Range:            -200.0 dBm to 50.0 dBm

Default Unit:    dBm

Remarks:        You must be in the cdma2000, W-CDMA, or 1xEV-DO mode to use this command. Use INSTRUMENT:SElect to set the mode.

### Spectrum Emission Mask—Offset Start Relative Power Limit

*cdma2000, W-CDMA mode*

```
[ :SENSE ] : SEMask : OFFSet [ n ] : LIST : START : RCARrier
<rel_power>, <rel_power>, <rel_power>, <rel_power>, <rel_power>
```

```
[ :SENSE ] : SEMask : OFFSet [ n ] : LIST : START : RCARrier?
```

*1xEV-DO mode*

```
[ :SENSE ] : SEMask : OFFSet : LIST [ m ] : START : RCARrier
<rel_power>, <rel_power>, <rel_power>, <rel_power>, <rel_power>
```

```
[ :SENSE ] : SEMask : OFFSet : LIST [ m ] : START : RCARrier?
```

Set a relative power level for each offset start limit. The list must contain five (5) entries. If there is more than one offset, the offset closest to the carrier channel comes first in the list.

The fail condition is set by [:SENS]:SEM:OFFS[n]:LIST[m]:TEST for

each offset channel test.

You can turn off (not use) specific offset channels with  
[:SENS]:SEM:OFFS[n]:LIST[m]:STAT.

The query returns the five (5) sets of the real values currently set to the relative power test limits.

OFFSet[n]      n=1 is the base station test and n=2 is the mobile test.  
The default is the base station test (1). (cdma2000,  
W-CDMA mode only)

LIST[m]        m=1 is the spectrum emission mask (SEM) mode and  
m=2 is the adjacent channel power (ACP) mode. The  
default is the SEM mode (1). (1xEV-DO mode only)

Factory Preset:

Mode	Variant	Offset A	Offset B	Offset C	Offset D	Offset E
<b>cdma2000</b>	BTS	-45.00 dB	-45.00 dB	-55.00 dB	-55.00 dB	-55.00 dB
	MS	-42.00 dB	-54.00 dB	-54.00 dB	-54.00 dB	-54.00 dB
<b>W-CDMA</b>	BTS	-30.00 dB	-30.00 dB	-30.00 dB	-30.00 dB	-30.00 dB
	MS	-33.73 dB	-34.00 dB	-37.50 dB	-47.50 dB	-47.50 dB
<b>1xEV-DO</b>	SEM	-45.00 dB	-45.00 dB	-55.00 dB	-55.00 dB	-55.00 dB
	ACP	-45.00 dB	-55.00 dB	-55.00 dB	-55.00 dB	-55.00 dB

Range:            -150.0 dBm to 50.0 dB

Default Unit:    dB

Remarks:        You must be in the cdma2000, W-CDMA, or 1xEV-DO  
mode to use this command. Use INSTRument:SElect to  
set the mode.

### Spectrum Emission Mask—Offset Measurement State

*cdma2000, W-CDMA mode*

```
[:SENSe]:SEMAsk:OFFSet [n]:LIST:STATe
OFF|ON|0|1,OFF|ON|0|1,OFF|ON|0|1,OFF|ON|0|1,OFF|ON|0|1
```

```
[:SENSe]:SEMAsk:OFFSet [n]:LIST:STATe?
```

*1xEV-DO mode*

```
[:SENSe]:SEMAsk:OFFSet:LIST [m]:STATe
OFF|ON|0|1,OFF|ON|0|1,OFF|ON|0|1,OFF|ON|0|1,OFF|ON|0|1
```

```
[:SENSe]:SEMAsk:OFFSet:LIST [m]:STATe?
```

Define whether or not to execute pass/fail tests at the offset channels. The pass/fail conditions are set by [:SENS]:SEM:OFFS[n]:LIST[m]:ABS or [:SENS]:SEM:OFFS[n]:LIST[m]:RCAR for each offset channel.

OFFSet[n]      n=1 is the base station test and n=2 is the mobile test. The default is the base station test (1). (cdma2000, W-CDMA mode only)

LIST[m]        m=1 is the spectrum emission mask (SEM) mode and m=2 is the adjacent channel power (ACP) mode. The default is the SEM mode (1). (1xEV-DO mode only)

Factory Preset:

Mode	Variant	Offset A	Offset B	Offset C	Offset D	Offset E
cdma2000	BTS	ON	ON	ON	OFF	OFF
	MS	ON	ON	OFF	OFF	OFF
W-CDMA	BTS	ON	ON	ON	ON	ON
	MS	ON	ON	ON	ON	OFF
1xEV-DO	SEM	ON	ON	ON	OFF	OFF
	ACP	ON	ON	OFF	OFF	OFF

Remarks:      You must be in the cdma2000, W-CDMA, or 1xEV-DO mode to use this command. Use INSTRument:SElect to set the mode.

### Spectrum Emission Mask—Offset Stop Absolute Power Limit

*cdma2000, W-CDMA mode*

```
[:SENSe]:SEMAsk:OFFSet [n]:LIST:STOP:ABSolute
<abs_power>,<abs_power>,<abs_power>,<abs_power>,<abs_power>
```

```
[:SENSe]:SEMAsk:OFFSet [n]:LIST:STOP:ABSolute?
```

*1xEV-DO. mode*

```
[:SENSe]:SEMAsk:OFFSet:LIST [m]:STOP:ABSolute
<abs_power>,<abs_power>,<abs_power>,<abs_power>,<abs_power>
```

```
[:SENSe]:SEMAsk:OFFSet:LIST [m]:STOP:ABSolute?
```

Set an absolute power level to for each offset stop limit. The list must contain five (5) entries. If there is more than one offset, the offset closest to the carrier channel comes first in the list.

The fail condition is set by [:SENS]:SEM:OFFS[n]:LIST[m]:TEST for each offset channel test.

You can turn off (not use) specific offset channels with  
[:SENS]:SEM:OFFS[n]:LIST[m]:STAT.

The query returns the five (5) sets of the real values currently set to the offset stop absolute power limits.

OFFSet[n]      n=1 is the base station test and n=2 is the mobile test.  
The default is the base station test (1). (cdma2000,  
W-CDMA mode only)

LIST[m]        m=1 is the spectrum emission mask (SEM) mode and  
m=2 is the adjacent channel power (ACP) mode. The  
default is the SEM mode (1). (1xEV-DO mode only)

Factory Preset:

Mode	Variant	Offset A	Offset B	Offset C	Offset D	Offset E
cdma2000	BTS	-27.00 dBm	-27.00 dBm	-27.00 dBm	-46.00 dBm	-13.00 dBm
	MS	-70.13 dBm	-70.13 dBm	-35.00 dBm	-13.00 dBm	-13.00 dBm
W-CDMA	BTS	-12.50 dBm	-24.50 dBm	-24.50 dBm	-11.50 dBm	-11.50 dBm
	MS	-69.57 dBm	-54.34 dBm	-54.34 dBm	-54.34 dBm	-54.34 dBm
1xEV-DO	SEM	-27.00 dBm	-27.00 dBm	-27.00 dBm	-46.00 dBm	-13.00 dBm
	ACP	-27.00 dBm	-27.00 dBm	-13.00 dBm	-13.00 dBm	-13.00 dBm

Range:            -200.0 dBm to 50.0 dBm

Default Unit:    dBm

Remarks:        You must be in the cdma2000, W-CDMA, or 1xEV-DO  
mode to use this command. Use INSTRument:SElect to  
set the mode.

### Spectrum Emission Mask—Couple Offset Stop Absolute Power Limit

*cdma2000, W-CDMA mode*

```
[:SENSe]:SEMAsk:OFFSet [n]:LIST:STOP:ABSolute:COUple  
OFF|ON|0|1,OFF|ON|0|1,OFF|ON|0|1,OFF|ON|0|1,OFF|ON|0|1
```

```
[:SENSe]:SEMAsk:OFFSet [n]:LIST:STOP:ABSolute:COUple?
```

*1xEV-DO mode*



```
[ :SENSe] :SEMAsk:OFFSet:LIST [m] :STOP:ABSolute:COUPle  
OFF | ON | 0 | 1, OFF | ON | 0 | 1, OFF | ON | 0 | 1, OFF | ON | 0 | 1, OFF | ON | 0 | 1
```

```
[ :SENSe] :SEMAsk:OFFSet:LIST [m] :STOP:ABSolute:COUPle?
```

Define whether or not to couple the offset stop absolute power limit to the offset start absolute power limit for each offset channel.

You can turn off (not use) specific offset channels with  
[:SENS]:SEM:OFFS[n]:LIST[m]:STAT.

OFFSet[n]      n=1 is the base station test and n=2 is the mobile test.  
The default is the base station test (1). (cdma2000,  
W-CDMA mode only)

LIST[m]        m=1 is the spectrum emission mask (SEM) mode and  
m=2 is the adjacent channel power (ACP) mode. The  
default is the SEM mode (1). (1xEV-DO mode only)

Factory Preset:

Mode	Variant	Offset A	Offset B	Offset C	Offset D	Offset E
<b>cdma2000</b>	BTS	ON	ON	ON	ON	ON
	MS	ON	ON	ON	ON	ON
<b>W-CDMA</b>	BTS	ON	OFF	ON	ON	ON
	MS	ON	ON	ON	ON	ON
<b>1xEV-DO</b>	SEM	ON	ON	ON	ON	ON
	ACP	ON	ON	ON	ON	ON

Remarks:      You must be in the cdma2000, W-CDMA, or 1xEV-DO  
mode to use this command. Use INSTRument:SElect to  
set the mode.

### Spectrum Emission Mask—Offset Stop Relative Power Limit

*cdma2000, W-CDMA mode*

```
[ :SENSe] :SEMAsk:OFFSet [n] :LIST:STOP:RCARrier  
<rel_power>, <rel_power>, <rel_power>, <rel_power>, <rel_power>
```

```
[ :SENSe] :SEMAsk:OFFSet [n] :LIST:STOP:RCARrier?
```

*1xEV-DO mode*

```
[ :SENSe] :SEMAsk:OFFSet:LIST [m] :STOP:RCARrier  
<rel_power>, <rel_power>, <rel_power>, <rel_power>, <rel_power>
```

```
[ :SENSe] :SEMAsk:OFFSet:LIST [m] :STOP:RCARrier?
```

Set a relative power level for each offset stop limit. The list must

contain five (5) entries. If there is more than one offset, the offset closest to the carrier channel comes first in the list.

The fail condition is set by [:SENS]:SEM:OFFS[n]:LIST[m]:TEST for each offset channel.

You can turn off (not use) specific offset channels with [:SENS]:SEM:OFFS[n]:LIST[m]:STAT.

The query returns the five (5) sets of the real values currently set to the offset stop relative power limits.

OFFSet[n]      n=1 is the base station test and n=2 is the mobile test. The default is the base station test (1). (cdma2000, W-CDMA mode only)

LIST[m]        m=1 is the spectrum emission mask (SEM) mode and m=2 is the adjacent channel power (ACP) mode. The default is the SEM mode (1). (1xEV-DO mode only)

Factory Preset:

Mode	Variant	Offset A	Offset B	Offset C	Offset D	Offset E
<b>cdma2000</b>	BTS	-45.00 dB	-45.00 dB	-55.00 dB	-55.00 dB	-55.00 dB
	MS	-42.00 dB	-54.00 dB	-54.00 dB	-54.00 dB	-54.00 dB
<b>W-CDMA</b>	BTS	-30.00 dB	-30.00 dB	-30.00 dB	-30.00 dB	-30.00 dB
	MS	-48.28 dB	-37.50 dB	-47.50 dB	-47.50 dB	-47.50 dB
<b>1xEV-DO</b>	SEM	-45.00 dB	-45.00 dB	-55.00 dB	-55.00 dB	-55.00 dB
	ACP	-45.00 dB	-55.00 dB	-55.00 dB	-55.00 dB	-55.00 dB

Range:            -150.0 dBm to 50.0 dB

Default Unit:    dB

Remarks:        You must be in the cdma2000, W-CDMA, or 1xEV-DO mode to use this command. Use INSTRument:SElect to set the mode.

### Spectrum Emission Mask—Couple Offset Stop Relative Power Limit

*cdma2000, W-CDMA mode*

```
[:SENSe]:SEMAsk:OFFSet [n]:LIST:STOP:RCARrier:COUple  
OFF|ON|0|1,OFF|ON|0|1,OFF|ON|0|1,OFF|ON|0|1,OFF|ON|0|1
```

```
[:SENSe]:SEMAsk:OFFSet [n]:LIST:STOP:RCARrier:COUple?
```

*1xEV-DO mode*

```
[ :SENSE ] :SEMAsk:OFFSet:LIST [m] :STOP:RCARrier:COUPle
OFF | ON | 0 | 1, OFF | ON | 0 | 1, OFF | ON | 0 | 1, OFF | ON | 0 | 1, OFF | ON | 0 | 1
```

```
[ :SENSE ] :SEMAsk:OFFSet:LIST [m] :STOP:RCARrier:COUPle?
```

Define whether or not to couple the offset stop relative power limit to the offset start relative power limit for each offset channel.

You can turn off (not use) specific offset channels with  
[:SENS]:SEM:OFFS[n]:LIST[m]:STAT.

OFFSet[n]      n=1 is the base station test and n=2 is the mobile test.  
The default is the base station test (1). (cdma2000,  
W-CDMA mode only)

LIST[m]        m=1 is the spectrum emission mask (SEM) mode and  
m=2 is the adjacent channel power (ACP) mode. The  
default is the SEM mode (1). (1xEV-DO mode only)

Factory Preset:

Mode	Variant	Offset A	Offset B	Offset C	Offset D	Offset E
<b>cdma2000</b>	BTS	ON	ON	ON	ON	ON
	MS	ON	ON	ON	ON	ON
<b>W-CDMA</b>	BTS	ON	ON	ON	ON	ON
	MS	OFF	OFF	OFF	ON	ON
<b>1xEV-DO</b>	SEM	ON	ON	ON	ON	ON
	ACP	ON	ON	ON	ON	ON

Remarks:      You must be in the cdma2000, W-CDMA, or 1xEV-DO  
mode to use this command. Use INSTRument:SElect to  
set the mode.

### Spectrum Emission Mask—Offset Channel Fail Condition

*cdma2000, W-CDMA mode*

```
[ :SENSE ] :SEMAsk:OFFSet [n] :LIST:TEST
ABSolute | AND | OR | RELative, ABSolute | AND | OR | RELative,
ABSolute | AND | OR | RELative, ABSolute | AND | OR | RELative,
ABSolute | AND | OR | RELative
```

```
[ :SENSE ] :SEMAsk:OFFSet [n] :LIST:TEST?
```

*1xEV-DO mode*

```
[ :SENSE ] :SEMAsk:OFFSet:LIST [m] :TEST
ABSolute | AND | OR | RELative, ABSolute | AND | OR | RELative,
ABSolute | AND | OR | RELative, ABSolute | AND | OR | RELative,
```

**ABSolute | AND | OR | RELative**

**[[:SENSe]:SEMMask:OFFSet:LIST[m]:TEST?**

Define one of the fail conditions for each offset channel limit test to be done. The absolute or relative power limit value for each offset channel is set by [:SENS]:SEM:OFFS[n]:LIST[m]:ABS or [:SENS]:SEM:OFFS[n]:LIST[m]:RCAR.

You can turn off (not use) specific offset channels with [:SENS]:SEM:OFFS[n]:LIST[m]:STAT.

**OFFSet[n]** n=1 is the base station test and n=2 is the mobile test. The default is the base station test (1). (cdma2000, W-CDMA mode only)

**LIST[m]** m=1 is the spectrum emission mask (SEM) mode and m=2 is the adjacent channel power (ACP) mode. The default is the SEM mode (1). (1xEV-DO mode only)

The fail condition that can be set for each offset channel include:

- **AND** - Tests the measurement result for an offset channel against both the absolute power limit and the relative power limit. If it fails, then returns a failure for that measurement test.
- **ABSolute** - Tests the measurement result for an offset channel against the absolute power limit. If it fails, then returns a failure for that measurement test.
- **OR** - Tests the measurement result for an offset channel against the absolute power limit OR the relative power limit. If either test fails, then returns a failure for that measurement test.
- **RELative** - Tests the measurement result for an offset channel against the relative power limit. If it fails, then returns a failure for that measurement test.

Factory Preset:

Mode	Variant	Offset A	Offset B	Offset C	Offset D	Offset E
<b>cdma2000</b>	BTS	REL	REL	REL	ABS	REL
	MS	AND	AND	ABS	REL	REL
<b>W-CDMA</b>	BTS	ABS	ABS	ABS	ABS	ABS
	MS	AND	AND	AND	AND	AND
<b>1xEV-DO</b>	SEM	REL	REL	REL	ABS	REL
	ACP	REL	REL	ABS	REL	REL

Remarks: You must be in the cdma2000, W-CDMA, or 1xEV-DO mode to use this command. Use INSTRument:SElect to

set the mode.

### Spectrum Emission Mask—Region Resolution Bandwidth

*cdma2000, W-CDMA mode*

```
[ :SENSe ] :SEMAsk:REGion [n] :LIST:BA NDwidth | BWIDTh  
<res_bw>,<res_bw>,<res_bw>,<res_bw>,<res_bw>
```

```
[ :SENSe ] :SEMAsk:REGion [n] :LIST:BA NDwidth | BWIDTh?
```

*1xEV-DO mode*

```
[ :SENSe ] :SEMAsk:REGion:LIST:BA NDwidth | BWIDTh  
<res_bw>,<res_bw>,<res_bw>,<res_bw>,<res_bw>
```

```
[ :SENSe ] :SEMAsk:REGion:LIST:BA NDwidth | BWIDTh?
```

Define the region resolution bandwidth(s) for spectrum emission measurements. The list must contain five (5) entries. You can turn off (not use) specific regions with [:SENS]:SEM:REG[n]:LIST:STAT.

REGion[n]      n=1 is the base station test and n=2 is the mobile test. The default is the base station test (1). (cdma2000, W-CDMA mode only)

Factory Preset and \*RST:      Auto coupled, except cdma2000, see below.

Range:              300 Hz to 7.5 MHz

Default Unit:      Hz

Mode	Variant	Region A	Region B	Region C	Region D	Region E
cdma2000	BTS	1.000 MHz	300.0 kHz	100.0 kHz	100.0 kHz	4.000 MHz
	MS	300.0 kHz	100.0 kHz	100.0 kHz	100.0 kHz	12.00 MHz

Remarks:              You must be in the cdma2000, W-CDMA, or 1xEV-DO mode to use this command. Use INSTRument:SElect to set the mode.

### Spectrum Emission Mask—Auto Region Resolution Bandwidth

*cdma2000, W-CDMA mode*

```
[ :SENSe ] :SEMAsk:REGion [n] :LIST:BA NDwidth | BWIDTh:AUTO  
OFF | ON | 0 | 1, OFF | ON | 0 | 1, OFF | ON | 0 | 1, OFF | ON | 0 | 1, OFF | ON | 0 | 1
```

```
[ :SENSe ] :SEMAsk:REGion [n] :LIST:BA NDwidth | BWIDTh:AUTO?
```

*1xEV-DO mode*

```
[ :SENSe] :SEMask:REGion:LIST:BANDwidth|BWIDth:AUTO  
OFF|ON|0|1,OFF|ON|0|1,OFF|ON|0|1,OFF|ON|0|1,OFF|ON|0|1
```

```
[ :SENSe] :SEMask:REGion:LIST:BANDwidth|BWIDth:AUTO?
```

Set the auto mode of the region step frequency.

Set the auto mode to determine the region resolution bandwidth to On or Off.

OFF - enter a value to set the resolution bandwidth for a region channel, referring to [:SENS]:SEM:REG[n]:LIST:BAND|BWID.

ON - the resolution bandwidth for a region channel is automatically set according to the region start and stop frequencies.

REGion[n]      n=1 is the base station test and n=2 is the mobile test.  
The default is the base station test (1). (cdma2000,  
W-CDMA mode only)

Factory Preset and \*RST:

Mode	Region A	Region B	Region C	Region D	Region E
cdma2000	OFF	OFF	OFF	OFF	OFF
W-CDMA	ON	ON	ON	ON	ON
1xEV-DO	ON	ON	ON	ON	ON

Remarks:      You must be in the cdma2000, W-CDMA, or 1xEV-DO mode to use this command. Use INSTRument:SElect to set the mode.

### Spectrum Emission Mask—Region Start Frequency

*cdma2000, W-CDMA mode*

```
[ :SENSe] :SEMask:REGion[n] :LIST:FREQuency:START  
<f_region>,<f_region>,<f_region>,<f_region>,<f_region>
```

```
[ :SENSe] :SEMask:REGion[n] :LIST:FREQuency:START?
```

*1xEV-DO mode*

```
[ :SENSe] :SEMask:REGion:LIST:FREQuency:START  
<f_region>,<f_region>,<f_region>,<f_region>,<f_region>
```

```
[ :SENSe] :SEMask:REGion:LIST:FREQuency:START?
```

Set the five (5) sets of the region start frequencies.

REGion[n]      n=1 is the base station test and n=2 is the mobile test.  
The default is the base station test (1). (cdma2000,

W-CDMA mode only)

Factory Preset and \*RST:

Mode	Variant	Region A	Region B	Region C	Region D	Region E
cdma2000	BTS	1920.5 MHz	1893.65 MHz	876.05 MHz	921.05 MHz	800.0 MHz
	MS	1920.5 MHz	925.05 MHz	935.05 MHz	1805.05 MHz	800.0 MHz
W-CDMA	n/a	1920.0 MHz	1893.5 MHz	2100.0 MHz	2175.0 MHz	800.0 MHz
1xEV-DO	n/a	1920.0 MHz	1893.5 MHz	2100.0 MHz	2175.0 MHz	800.0 MHz

Range: 329.0 MHz to 3.678 GHz

Default Unit: Hz

Remarks: You must be in the cdma2000, W-CDMA, or 1xEV-DO mode to use this command. Use INSTRUMENT:SElect to set the mode.

### Spectrum Emission Mask—Region Step Frequency

*cdma2000, W-CDMA mode*

```
[ :SENSE ] :SEMAsk:REGion [n] :LIST:FREQuency:STEP
<f_region>,<f_region>,<f_region>,<f_region>,<f_region>
```

```
[ :SENSe ] :SEMAsk:REGion [n] :LIST:FREQuency:STEP?
```

*1xEV-DO mode*

```
[ :SENSE ] :SEMAsk:REGion:LIST:FREQuency:STEP
<f_region>,<f_region>,<f_region>,<f_region>,<f_region>
```

```
[ :SENSe ] :SEMAsk:REGion:LIST:FREQuency:STEP?
```

Sets the five (5) sets of the region step frequencies.

REGion[n] n=1 is the base station test and n=2 is the mobile test. The default is the base station test (1). (cdma2000, W-CDMA mode only)

Factory Preset: No valid value as the default is set to Auto. See [ :SENS ] :SEM:REG [n] :LIST:FREQ:STEP:AUTO.

Range: 100 Hz to 7.5 MHz

The minimum value is determined to be equal to or greater than one 2000th (1/2000) of the frequency difference derived from (Stop Freq – Start Freq).

Default Unit: Hz

Remarks: You must be in the cdma2000, W-CDMA, or 1xEV-DO mode to use this command. Use INSTRument:SElect to set the mode.

### Spectrum Emission Mask—Auto Region Step Frequency

*cdma2000, W-CDMA mode*

```
[ :SENSe ] :SEMask:REGion [n] :LIST:FREQuency:STEP:AUTO  
OFF|ON|0|1, OFF|ON|0|1, OFF|ON|0|1, OFF|ON|0|1, OFF|ON|0|1
```

```
[ :SENSe ] :SEMask:REGion [n] :LIST:FREQuency:STEP:AUTO?
```

*1xEV-DO mode*

```
[ :SENSe ] :SEMask:REGion:LIST:FREQuency:STEP:AUTO  
OFF|ON|0|1, OFF|ON|0|1, OFF|ON|0|1, OFF|ON|0|1, OFF|ON|0|1
```

```
[ :SENSe ] :SEMask:REGion:LIST:FREQuency:STEP:AUTO?
```

Set the auto mode to determine the region step frequency to On or Off.

OFF - enter a value to set the step frequency for a region channel, referring to [:SENS]:SEM:REG[n]:LIST:FREQ:STEP.

ON - the step frequency for a region channel is automatically set according to the region start and stop frequencies.

REGion[n] n=1 is the base station test and n=2 is the mobile test. The default is the base station test (1). (cdma2000, W-CDMA mode only)

Factory Preset:

Mode	Region A	Region B	Region C	Region D	Region E
cdma2000	ON	ON	ON	ON	ON
W-CDMA	ON	ON	ON	ON	ON
1xEV-DO	ON	ON	ON	ON	ON

Remarks: You must be in the cdma2000, W-CDMA, or 1xEV-DO mode to use this command. Use INSTRument:SElect to set the mode.

### Spectrum Emission Mask—Region Stop Frequency

*cdma2000, W-CDMA mode*

```
[ :SENSe ] :SEMask:REGion [n] :LIST:FREQuency:STOP  
<f_region>, <f_region>, <f_region>, <f_region>, <f_region>
```



[ :SENSe] :SEMAsk:REGion [n] :LIST:FREQuency:STOP?

*1xEV-DO mode*

[ :SENSe] :SEMAsk:REGion:LIST:FREQuency:STOP

<f\_region>,<f\_region>,<f\_region>,<f\_region>,<f\_region>

[ :SENSe] :SEMAsk:REGion:LIST:FREQuency:STOP?

Sets the five (5) sets of the region stop frequencies.

REGion[n]      n=1 is the base station test and n=2 is the mobile test.  
The default is the base station test (1). (cdma2000,  
W-CDMA mode only)

Factory Preset and \*RST:

Mode	Variant	Region A	Region B	Region C	Region D	Region E
<b>cdma2000</b>	BTS	1980.5 MHz	1919.75 MHz	915.05 MHz	960.05 MHz	1000.0 MHz
	MS	1980.5 MHz	935.05 MHz	960.05 MHz	1880.05 MHz	1000.0 MHz
<b>W-CDMA</b>	n/a	1980.0 MHz	1919.6 MHz	2105.0 MHz	2180.0 MHz	1000.0 MHz
<b>1xEV-DO</b>	n/a	1980.0 MHz	1919.6 MHz	2105.0 MHz	2180.0 MHz	1000.0 MHz

Range:            329.0 MHz to 3.678 MHz

Default Unit:    Hz

Remarks:        You must be in the cdma2000, W-CDMA, or 1xEV-DO mode to use this command. Use INSTRument:SElect to set the mode.

### Spectrum Emission Mask—Region Relative Attenuation

*cdma2000, W-CDMA mode*

[ :SENSe] :SEMAsk:REGion [n] :LIST:RATTenuation

<rel\_power>,<rel\_power>,<rel\_power>,<rel\_power>,<rel\_power>

[ :SENSe] :SEMAsk:REGion [n] :LIST:RATTenuation?

*1xEV-DO mode*

[ :SENSe] :SEMAsk:REGion:LIST:RATTenuation

<rel\_power>,<rel\_power>,<rel\_power>,<rel\_power>,<rel\_power>

[ :SENSe] :SEMAsk:REGion:LIST:RATTenuation?

Set a relative amount of attenuation for measurements made at a region. The amount is specified relative to the attenuation required to measure the carrier channel power. Since the region channel power is

lower than the carrier channel power, less attenuation is required to measure the region channel and you get wider dynamic range for the measurement.

You can turn off (not use) specific regions with  
[:SENSe]:SEM:REG[n]:LIST:STAT.

REGion[n]      n=1 is the base station test and n=2 is the mobile test.  
The default is the base station test (1). (cdma2000,  
W-CDMA mode only)

Factory Preset:

Mode	Variant	Region A	Region B	Region C	Region D	Region E
cdma2000	BTS	0.00 dB	0.00 dB	0.00 dB	0.00 dB	0.00 dB
	MS	0.00 dB	0.00 dB	0.00 dB	0.00 dB	0.00 dB
W-CDMA	n/a	0.00 dB	0.00 dB	0.00 dB	0.00 dB	0.00 dB
1xEV-DO	n/a	0.00 dB	0.00 dB	0.00 dB	0.00 dB	0.00 dB

Range:            -40.00 to 0.00 dB, but this relative attenuation cannot  
exceed the absolute attenuation ranging from 0.00 to  
40.00 dB.

Remarks:        Remember that the attenuation that you specify is  
always relative to the amount of attenuation used for  
the carrier channel. Selecting negative attenuation  
means that you want less attenuation used. For  
example, if the measurement must use 20 dB of  
attenuation for the carrier measurement and you want  
to use 12 dB less attenuation for the first region, you  
would send the value -12 dB.

You must be in the cdma2000, W-CDMA, or 1xEV-DO  
mode to use this command. Use INSTRument:SElect to  
set the mode.

### Spectrum Emission Mask—Region Start Absolute Power Limit

*cdma2000, W-CDMA (3GPP) mode*

```
[:SENSe]:SEMMask:REGion [n] :LIST:START:ABSolute  
<abs_power>,<abs_power>,<abs_power>,<abs_power>,<abs_power>
```

```
[:SENSe]:SEMMask:REGion [n] :LIST:START:ABSolute?
```

*1xEV-DO mode*

```
[:SENSe]:SEMMask:REGion:LIST:START:ABSolute  
<abs_power>,<abs_power>,<abs_power>,<abs_power>,<abs_power>
```

**[[:SENSe]:SEMAsk:REGion:LIST:START:ABSolute?**

Set an absolute power level for each region start limit. The list must contain five (5) entries. If there is more than one region, the region closest to the carrier channel comes first in the list.

The fail condition for each region channel is set by  
[:SENS]:SEM:REG[n]:LIST:TEST.

You can turn off (not use) specific regions with  
[:SENS]:SEM:REG[n]:LIST:STAT.

The query returns the five (5) sets of the real values currently set to the absolute power test limits.

REGion[n]      n=1 is the base station test and n=2 is the mobile test.  
The default is the base station test (1). (cdma2000,  
W-CDMA mode only)

Factory Preset:

Mode	Variant	Region A	Region B	Region C	Region D	Region E
cdma2000	BTS	-86.00 dBm	-41.00 dBm	-98.00 dBm	-57.00 dBm	-50.00 dBm
	MS	-41.00 dBm	-67.00 dBm	-79.00 dBm	-71.00 dBm	-50.00 dBm
W-CDMA		-50.00 dBm	-50.00 dBm	-50.00 dBm	-50.00 dBm	-50.00 dBm
1xEV-DO		-50.00 dBm	-50.00 dBm	-50.00 dBm	-50.00 dBm	-50.00 dBm

Range:            -200.00 dBm to 50.00 dBm

Default Unit:    dBm

Remarks:        You must be in the cdma2000, W-CDMA, or 1xEV-DO mode to use this command. Use INSTRument:SElect to set the mode.

### Spectrum Emission Mask—Region Start Relative Power Limit

*cdma2000, W-CDMA mode*

**[[:SENSe]:SEMAsk:REGion [n]:LIST:START:RCARrier  
<rel\_power>,<rel\_power>,<rel\_power>,<rel\_power>,<rel\_power>**

**[[:SENSe]:SEMAsk:REGion [n]:LIST:START:RCARrier?**

*1xEV-DO mode*

**[[:SENSe]:SEMAsk:REGion:LIST:START:RCARrier  
<rel\_power>,<rel\_power>,<rel\_power>,<rel\_power>,<rel\_power>**

**[[:SENSe]:SEMAsk:REGion:LIST:START:RCARrier?**

Set a relative power level for each region start limit. The list must

contain five (5) entries. If there is more than one region, the region closest to the carrier channel comes first in the list.

The fail condition is set by [:SENS]:SEM:REG[n]:LIST:TEST for each region test.

You can turn off (not use) specific regions with [:SENS]:SEM:REG[n]:LIST:STAT.

The query returns the five (5) sets of the real values currently set to the relative power test limits.

REGion[n]      n=1 is the base station test and n=2 is the mobile test.  
The default is the base station test (1). (cdma2000, W-CDMA mode only)

Factory Preset:

Mode	Region A	Region B	Region C	Region D	Region E
cdma2000	-30.00 dB	-30.00 dB	-30.00 dB	-30.00 dB	-30.00 dB
W-CDMA	-30.00 dB	-30.00 dB	-30.00 dB	-30.00 dB	-30.00 dB
1xEV-DO	-30.00 dB	-30.00 dB	-30.00 dB	-30.00 dB	-30.00 dB

Range:            -150.00 dBm to 50.00 dB

Default Unit:    dB

Remarks:        You must be in the cdma2000, W-CDMA, or 1xEV-DO mode to use this command. Use INSTRument:SElect to set the mode.

### Spectrum Emission Mask—Control Region List State

*cdma2000, W-CDMA mode*

```
[:SENSe]:SEMAsk:REGion[n]:LIST:STATe
OFF|ON|0|1,OFF|ON|0|1,OFF|ON|0|1,OFF|ON|0|1,OFF|ON|0|1
```

```
[:SENSe]:SEMAsk:REGion[n]:LIST:STATe?
```

*1xEV-DO mode*

```
[:SENSe]:SEMAsk:REGion:LIST:STATe
OFF|ON|0|1,OFF|ON|0|1,OFF|ON|0|1,OFF|ON|0|1,OFF|ON|0|1
```

```
[:SENSe]:SEMAsk:REGion:LIST:STATe?
```

Define whether or not to execute pass/fail tests at custom region frequencies. The pass/fail conditions are set by [:SENS]:SEM:REG[n]:LIST:ABS or [:SENS]:SEM:REG[n]:LIST:RCAR for each region.

REGion[n] n=1 is the base station test and n=2 is the mobile test.  
The default is the base station test (1). (cdma2000,  
W-CDMA mode only)

Factory Preset and \*RST:

Mode	Region A	Region B	Region C	Region D	Region E
cdma2000	ON	ON	OFF	OFF	OFF
W-CDMA	ON	ON	ON	OFF	OFF
1xEV-DO	ON	ON	ON	OFF	OFF

Remarks: You must be in the cdma2000, W-CDMA, or 1xEV-DO mode to use this command. Use INSTRument:SElect to set the mode.

### Spectrum Emission Mask—Region Stop Absolute Power Limit

*cdma2000, W-CDMA mode*

```
[ :SENSE] :SEMask:REGion [n] :LIST:STOP:ABSolute  
<abs_power>,<abs_power>,<abs_power>,<abs_power>,<abs_power>
```

```
[ :SENSe] :SEMask:REGion [n] :LIST:STOP:ABSolute?
```

*1xEV-DO mode*

```
[ :SENSE] :SEMask:REGion:LIST:STOP:ABSolute  
<abs_power>,<abs_power>,<abs_power>,<abs_power>,<abs_power>
```

```
[ :SENSE] :SEMask:REGion:LIST:STOP:ABSolute?
```

Set an absolute power level for each region stop limit. The list must contain five (5) entries. If there is more than one region, the region closest to the carrier channel comes first in the list.

The fail condition is set by [:SENS]:SEM:REG[n]:LIST:TEST for each region test.

You can turn off (not use) specific regions with [:SENS]:SEM:REG[n]:LIST:STAT.

The query returns the five (5) sets of the real values currently set to the region stop absolute power limits.

REGion[n] n=1 is the base station test and n=2 is the mobile test.  
The default is the base station test (1). (cdma2000,  
W-CDMA mode only)

Factory Preset and \*RST:

Mode	Variant	Region A	Region B	Region C	Region D	Region E
<b>cdma2000</b>	BTS	-86.00 dBm	-41.00 dBm	-98.00 dBm	-57.00 dBm	-50.00 dBm
	MS	-41.00 dBm	-67.00 dBm	-79.00 dBm	-71.00 dBm	-50.00 dBm
<b>W-CDMA</b>	n/a	-50.00 dBm	-50.00 dBm	-50.00 dBm	-50.00 dBm	-50.00 dBm
<b>1xEV-DO</b>	n/a	-50.00 dBm	-50.00 dBm	-50.00 dBm	-50.00 dBm	-50.00 dBm

Range: -200.00 dBm to 50.00 dBm

Unit: dBm

Remarks: You must be in the cdma2000, W-CDMA, or 1xEV-DO mode to use this command. Use INSTRUMENT:SElect to set the mode.

### Spectrum Emission Mask—Couple Region Stop Absolute Power Limit

`[ :SENSe ] :SEMAsk:REGion [n] :LIST:STOP:ABSolute:COUple  
OFF | ON | 0 | 1 { , OFF | ON | 0 | 1 }`

`[ :SENSe ] :SEMAsk:REGion [n] :LIST:STOP:ABSolute:COUple?`

Define whether or not to couple the region stop absolute power limit to the region start absolute power limit for each region.

You can turn off (not use) specific regions with  
`[ :SENS ] :SEM:REG[n] :LIST:STAT.`

REGion[n] n=1 is the base station test and n=2 is the mobile test. The default is the base station test (1). (cdma2000, W-CDMA mode only)

Factory Preset:

Mode	Region A	Region B	Region C	Region D	Region E
<b>cdma2000</b>	ON	ON	ON	ON	ON
<b>W-CDMA</b>	ON	ON	ON	ON	ON
<b>1xEV-DO</b>	ON	ON	ON	ON	ON

Remarks: You must be in the cdma2000, W-CDMA, or 1xEV-DO mode to use this command. Use INSTRUMENT:SElect to set the mode.

### Spectrum Emission Mask—Region Stop Relative Power Limit

*cdma2000, W-CDMA mode*

```
[ :SENSe] :SEMAsk:REGion [n] :LIST:STOP:RCARrier
<rel_power>, <rel_power>, <rel_power>, <rel_power>, <rel_power>
```

```
[ :SENSe] :SEMAsk:REGion [n] :LIST:STOP:RCARrier?
```

*1xEV-DO mode*

```
[ :SENSe] :SEMAsk:REGion:LIST:STOP:RCARrier
<rel_power>, <rel_power>, <rel_power>, <rel_power>, <rel_power>
```

```
[ :SENSe] :SEMAsk:REGion:LIST:STOP:RCARrier?
```

Set a relative power level for each region stop limit. The list must contain five (5) entries. If there is more than one region, the region closest to the carrier channel comes first in the list.

The fail condition is set by [:SENS]:SEM:REG[n]:LIST[m]:TEST for each region.

You can turn off (not use) specific regions with [:SENS]:SEM:REG[n]:LIST:STAT.

The query returns the five (5) sets of the real values currently set to the region stop relative power limits.

REGion[n]      n=1 is the base station test and n=2 is the mobile test. The default is the base station test (1). (cdma2000, W-CDMA mode only)

Factory Preset:

Mode	Region A	Region B	Region C	Region D	Region E
<b>cdma2000</b>	-30.00 dB	-30.00 dB	-30.00 dB	-30.00 dB	-30.00 dB
<b>W-CDMA</b>	-30.00 dB	-30.00 dB	-30.00 dB	-30.00 dB	-30.00 dB
<b>1xEV-DO</b>	-30.00 dB	-30.00 dB	-30.00 dB	-30.00 dB	-30.00 dB

Range:            -150.00 dBm to 50.00 dB

Default Unit:    dB

Remarks:        You must be in the cdma2000, W-CDMA, or 1xEV-DO mode to use this command. Use INSTRument:SElect to set the mode.

### Spectrum Emission Mask—Couple Region Stop Relative Power Limit

*cdma2000, W-CDMA mode*

```
[ :SENSe ] :SEMask:REGion [n] :LIST:STOP:RCARrier:COUple
OFF | ON | 0 | 1, OFF | ON | 0 | 1, OFF | ON | 0 | 1, OFF | ON | 0 | 1, OFF | ON | 0 | 1
```

```
[ :SENSe ] :SEMask:REGion [n] :LIST:STOP:RCARrier:COUple?
```

*1xEV-DO mode*

```
[ :SENSe ] :SEMask:REGion:LIST:STOP:RCARrier:COUple
OFF | ON | 0 | 1, OFF | ON | 0 | 1, OFF | ON | 0 | 1, OFF | ON | 0 | 1, OFF | ON | 0 | 1
```

```
[ :SENSe ] :SEMask:REGion:LIST:STOP:RCARrier:COUple?
```

Define whether or not to couple the region stop relative power limit to the region start relative power limit for each region.

You can turn off (not use) specific regions with  
[:SENS]:SEM:REG[n]:LIST:STAT.

REGion[n]      n=1 is the base station test and n=2 is the mobile test.  
The default is the base station test (1). (cdma2000,  
W-CDMA mode only)

Factory Preset:

Mode	Region A	Region B	Region C	Region D	Region E
cdma2000	ON	ON	ON	ON	ON
W-CDMA	ON	ON	ON	ON	ON
1xEV-DO	ON	ON	ON	ON	ON

Remarks:      You must be in the cdma2000, W-CDMA, or 1xEV-DO mode to use this command. Use INSTRument:SElect to set the mode.

### Spectrum Emission Mask—Region Limit Test Fail Condition

*cdma2000, W-CDMA mode*

```
[ :SENSe ] :SEMask:REGion [n] :LIST:TEST
ABSolute | AND | OR | RELative, ABSolute | AND | OR | RELative,
ABSolute | AND | OR | RELative, ABSolute | AND | OR | RELative,
ABSolute | AND | OR | RELative
```

```
[ :SENSe ] :SEMask:REGion [n] :LIST:TEST?
```

*1xEV-DO mode*

```
[ :SENSe ] :SEMask:REGion:LIST:TEST
ABSolute | AND | OR | RELative, ABSolute | AND | OR | RELative,
ABSolute | AND | OR | RELative, ABSolute | AND | OR | RELative,
ABSolute | AND | OR | RELative
```

```
[ :SENSe ] :SEMask:REGion:LIST:TEST?
```



Define one of the fail conditions for each region limit test to be done. The absolute or relative test limit value for each region is set by [:SENS]:SEM:REG[n]:LIST:ABS or [:SENS]:SEM:REG[n]:LIST:RCAR.

You can turn off (not use) specific regions with [:SENS]:SEM:REG[n]:LIST[m]:STAT.

REGion[n]      n=1 is the base station test and n=2 is the mobile test. The default is the base station test (1). (cdma2000, W-CDMA mode only)

The fail condition that can be set for each region test include:

- AND - Tests the measurement result for a region against both the absolute power limit and the relative power limit. If it fails, then returns a failure for that measurement test.
- ABSolute - Tests the measurement result for a region against the absolute power limit. If it fails, then returns a failure for that measurement test.
- OR - Tests the measurement result for a region against the absolute power limit OR the relative power limit. If either test fails, then returns a failure for that measurement test.
- RELative - Tests the measurement result for a region against the relative power limit. If it fails, then returns a failure for that measurement test.

Factory Preset:

Mode	Region A	Region B	Region C	Region D	Region E
cdma2000	ABS	ABS	ABS	ABS	ABS
W-CDMA	ABS	ABS	ABS	ABS	ABS
1xEV-DO	ABS	ABS	ABS	ABS	ABS

Remarks:      You must be in the cdma2000, W-CDMA, or 1xEV-DO mode to use this command. Use INSTRument:SElect to set the mode.

### Spectrum Emission Mask—Spectrum Segment

[:SENSe]:SEMAsk:SEGment OFFSet|REGion

[:SENSe]:SEMAsk:SEGment?

Set the frequency spectrum measurement segment to either the offset channels with relative frequencies or the regions with absolute frequencies.

Factory Preset: OFFset

Remarks: You must be in the cdma2000, W-CDMA, or 1xEV-DO mode to use this command. Use INSTRument:SElect to set the mode.

### Spectrum Emission Mask—Measurement Interval

```
[ :SENSe ] :SEMask:SWEep:TIME <time> | <no. of chips>
```

```
[ :SENSe ] :SEMask:SWEep:TIME?
```

Specify the time length in  $\mu\text{s}$  or number of chips, for the measurement interval that is the data acquisition time for each bin.

Factory Preset: 1 ms

182.3  $\mu\text{s}$  or 224 chips (for 1xEV-DO)

Range: 100  $\mu\text{s}$  to 10 ms

10.0  $\mu\text{s}$  to 10.0 ms or 12.3 to 12300 chips (for 1xEV-DO)

Default Unit: seconds

Remarks: You must be in the cdma2000, W-CDMA, or 1xEV-DO mode to use this command. Use INSTRument:SElect to set the mode.

### Spectrum Emission Mask—Trigger Source

```
[ :SENSe ] :SEMask:TRIGger:SOURce  
EXTErnal [1] | EXTErnal2 | FRAME | IMMEDIATE | LINE
```

```
[ :SENSe ] :SEMask:TRIGger:SOURce?
```

Select one of the trigger sources used to control the data acquisitions.

EXTErnal 1 – front panel external trigger input

EXTErnal 2 – rear panel external trigger input

FRAME – internal frame trigger

IMMEDIATE – the next data acquisition is immediately taken, capturing the signal asynchronously (also called free run).

LINE – power line

Factory Preset: IMMEDIATE

Remarks: You must be in the cdma2000, W-CDMA, or 1xEV-DO mode to use this command. Use INSTRument:SElect to set the mode.

## Spectrum Emission Mask—Power Reference

[ :SENSE ] :SEMask:TYPE PSDRef | TPreF

[ :SENSE ] :SEMask:TYPE?

Set the power measurement reference type. This allows you to make absolute and relative power measurements of either total power or the power normalized to the measurement bandwidth.

PSDRef - the power spectral density is used as the power reference

TPRef - the total power is used as the power reference

Factory Preset: TPreF

Remarks: You must be in the cdma2000, W-CDMA, 1xEV-DO mode to use this command. Use INSTRument:SElect to set the mode.

## Spectrum (Frequency-Domain) Measurement

Commands for querying the spectrum measurement results and for setting to the default values are found in the “MEASure Group of Commands” on page 318. The equivalent front panel keys for the parameters described in the following commands, are found under the **Meas Setup** key, after the **Spectrum (Freq Domain)** measurement has been selected from the **MEASURE** key menu.

### Spectrum—Data Acquisition Packing

```
[ :SENSe ] :SPEctrum:ACQuisition:PACKing  
AUTO | LONG | MEDium | SHORt
```

```
[ :SENSe ] :SPEctrum:ACQuisition:PACKing?
```

Select the amount of data acquisition packing. This is an advanced control that normally does not need to be changed.

Factory Preset: AUTO

Remarks: You must be in the Basic, cdmaOne, cdma2000, 1xEV-DO, W-CDMA, GSM, EDGE, NADC, or PDC mode to use this command. Use INSTRument:SElect to set the mode.

### Spectrum—ADC Dither

```
[ :SENSe ] :SPEctrum:ADC:DITHer [ :STATe ] AUTO | ON | OFF | 2 | 1 | 0
```

```
[ :SENSe ] :SPEctrum:ADC:DITHer [ :STATe ] ?
```

Turn the ADC dither on or off. This is an advanced control that normally does not need to be changed.

Factory Preset: AUTO

Remarks: You must be in the Basic, cdmaOne, cdma2000, 1xEV-DO, W-CDMA, GSM, EDGE, NADC, or PDC mode to use this command. Use INSTRument:SElect to set the mode.

### Spectrum—ADC Range

```
[ :SENSe ] :SPEctrum:ADC:RANGe  
AUTO | APEak | APLock | NONE | P0 | P6 | P12 | P18
```

```
[ :SENSe ] :SPEctrum:ADC:RANGe?
```

Select the range for the gain-ranging that is done in front of the ADC. This is an advanced control that normally does not need to be changed. Auto peak ranging is the default for this measurement. If you are

measuring a CW signal please see the description below.

- AUTO - automatic range

For FFT spectrums - auto ranging should not be used. An exception to this would be if you know that your signal is “bursty”. Then you might use auto to maximize the time domain dynamic range as long as you are not very interested in the FFT data.

- Auto Peak (APEak) - automatically peak the range

For CW signals, the default of auto-peak ranging can be used, but a better FFT measurement of the signal can be made by selecting one of the manual ranges that are available: M6, P0 - P24. Auto peaking can cause the ADC range gain to move monotonically down during the data capture. This movement should have negligible effect on the FFT spectrum, but selecting a manual range removes this possibility. Note that if the CW signal being measured is close to the auto-ranging threshold, the noise floor may shift as much as 6 dB from sweep to sweep.

- Auto Peak Lock (APLock) - automatically peak lock the range

For CW signals, auto-peak lock ranging may be used. It will find the best ADC measurement range for this particular signal and will not move the range as auto-peak can. Note that if the CW signal being measured is close to the auto-ranging threshold, the noise floor may shift as much as 6 dB from sweep to sweep. For “bursty” signals, auto-peak lock ranging should not be used. The measurement will fail to operate, since the wrong (locked) ADC range will be chosen often and overloads will occur in the ADC.

- NONE - turns off any auto-ranging without making any changes to the current setting.
- P0 to P18 - manually selects ADC ranges that add 0 to 18 dB of fixed gain across the range. Manual ranging is best for CW signals.

Factory Preset: APEak

Remarks: You must be in the Basic, cdmaOne, cdma2000, 1xEV-DO, W-CDMA, GSM, EDGE, NADC, or PDC mode to use this command. Use INSTRument:SElect to set the mode.

### Spectrum—Average Clear

[ :SENSe] :SPECTrum:AVERAge:CLEar

The average data is cleared and the average counter is reset.

Remarks: You must be in the Basic, cdmaOne, cdma2000, 1xEV-DO, W-CDMA, GSM, EDGE, NADC, or PDC mode to use this command. Use INSTRument:SElect to set the mode.

### Spectrum—Number of Averages

```
[ :SENSe ] :SPECTrum:AVERage:COUNT <integer>
```

```
[ :SENSe ] :SPECTrum:AVERage:COUNT?
```

Set the number of ‘sweeps’ that will be averaged. After the specified number of ‘sweeps’ (average counts), the averaging mode (terminal control) setting determines the averaging action.

Factory Preset: 25

Range: 1 to 10,000

Remarks: You must be in the Basic, cdmaOne, cdma2000, 1xEV-DO, W-CDMA, GSM, EDGE, NADC, or PDC mode to use this command. Use INSTRument:SElect to set the mode.

### Spectrum—Averaging State

```
[ :SENSe ] :SPECTrum:AVERage [ :STATe ] OFF | ON | 0 | 1
```

```
[ :SENSe ] :SPECTrum:AVERage [ :STATe ] ?
```

Turn averaging on or off.

Factory Preset: ON

Remarks: You must be in the Basic, cdmaOne, cdma2000, 1xEV-DO, W-CDMA, GSM, EDGE, NADC, or PDC mode to use this command. Use INSTRument:SElect to set the mode.

### Spectrum—Averaging Mode

```
[ :SENSe ] :SPECTrum:AVERage:TCONtrol EXPonential | REPeat
```

```
[ :SENSe ] :SPECTrum:AVERage:TCONtrol?
```

Select the type of termination control used for the averaging function. This determines the averaging action after the specified number of ‘sweeps’ (average count) is reached.

EXPonential - Each successive data acquisition after the average count is reached, is exponentially weighted and combined with the

existing average.

REPeat - After reaching the average count, the averaging is reset and a new average is started.

Factory Preset: EXPonential

Remarks: You must be in the Basic, cdmaOne, cdma2000, 1xEV-DO, W-CDMA, GSM, EDGE, NADC, or PDC mode to use this command. Use INSTRument:SElect to set the mode.

### Spectrum—Averaging Type

```
[ :SENSe] :SPECTrum:AVERAge:TYPE
LOG | MAXimum | MINimum | RMS | SCALar
```

```
[ :SENSe] :SPECTrum:AVERAge:TYPE?
```

Select the type of averaging.

LOG – The log of the power is averaged. (This is also known as video averaging.)

MAXimum – The maximum values are retained.

MINimum – The minimum values are retained.

RMS – The power is averaged, providing the rms of the voltage.

SCALar – The voltage is averaged.

Factory Preset: LOG

Remarks: You must be in the Basic, cdmaOne, cdma2000, 1xEV-DO, W-CDMA, GSM, EDGE, NADC, or PDC mode to use this command. Use INSTRument:SElect to set the mode.

### Spectrum— Select Pre-FFT Bandwidth

```
[ :SENSe] :SPECTrum:BANDwidth | BWIDth:IF:AUTO OFF | ON | 0 | 1
```

```
[ :SENSe] :SPECTrum:BANDwidth | BWIDth:IF:AUTO?
```

Select auto or manual control of the pre-FFT BW.

Factory Preset: AUTO, 1.55 MHz

Remarks: You must be in the Basic, cdmaOne, cdma2000, 1xEV-DO, W-CDMA, GSM, EDGE, NADC, or PDC mode to use this command. Use INSTRument:SElect to set the mode.

Front Panel

Access: **Measure, Spectrum, Meas Setup, More, Advanced, Pre-FFT BW.**

### Spectrum — IF Flatness Corrections

```
[ :SENSe ] :SPECTrum: BANDwidth | BWIDth: IF: FLATness OFF | ON | 0 | 1
```

```
[ :SENSe ] :SPECTrum: BANDwidth | BWIDth: IF: FLATness?
```

Turns IF flatness corrections on and off.

Factory Preset: ON

Remarks: You must be in the Basic, cdmaOne, cdma2000, 1xEV-DO, W-CDMA, GSM, EDGE, NADC, or PDC mode to use this command. Use INSTRument:SElect to set the mode.

Front Panel

Access: **Measure, Spectrum, Meas Setup, More, Advanced, Pre-FFT BW**

### Spectrum—Pre-ADC Bandpass Filter

```
[ :SENSe ] :SPECTrum: BANDwidth | BWIDth: PADC OFF | ON | 0 | 1
```

```
[ :SENSe ] :SPECTrum: BANDwidth | BWIDth: PADC?
```

Turn the pre-ADC bandpass filter on or off. This is an advanced control that normally does not need to be changed.

Remarks: You must be in the Basic, cdmaOne, cdma2000, 1xEV-DO, W-CDMA, GSM, EDGE, NADC, or PDC mode to use this command. Use INSTRument:SElect to set the mode.

### Spectrum—Pre-FFT BW

```
[ :SENSe ] :SPECTrum: BANDwidth | BWIDth: PFFT [ :SIZE ] <freq>
```

```
[ :SENSe ] :SPECTrum: BANDwidth | BWIDth: PFFT [ :SIZE ] ?
```

Set the pre-FFT bandwidth. This is an advanced control that normally does not need to be changed.

Frequency span, resolution bandwidth, and the pre-FFT bandwidth settings are normally coupled. If you are not auto-coupled, there can be combinations of these settings that are not valid.

Factory Preset: 1.55 MHz

1.25 MHz for cdmaOne



Range: 1 Hz to 10.0 MHz

Remarks: You must be in the Basic, cdmaOne, cdma2000, 1xEV-DO, W-CDMA, GSM, EDGE, NADC, or PDC mode to use this command. Use INSTRUMENT:SElect to set the mode.

### Spectrum—Pre-FFT BW Filter Type

```
[ :SENSe ] :SPECTrum:BAWdwidth|BWIDth:PPFT:TYPE FLAT|GAUSSian
[ :SENSe ] :SPECTrum:BAWdwidth|BWIDth:PPFT:TYPE?
```

Select the type of pre-FFT filter that is used. This is an advanced control that normally does not need to be changed.

Flat top (FLAT)- a filter with a flat amplitude response, which provides the best amplitude accuracy.

GAUSSian - a filter with Gaussian characteristics, which provides the best pulse response.

Factory Preset: FLAT

Remarks: You must be in the Basic, cdmaOne, cdma2000, 1xEV-DO, W-CDMA, GSM, EDGE, NADC, or PDC mode to use this command. Use INSTRUMENT:SElect to set the mode.

### Spectrum—Resolution BW

```
[ :SENSe ] :SPECTrum:BAWdwidth|BWIDth[:RESolution] <freq>
[ :SENSe ] :SPECTrum:BAWdwidth|BWIDth[:RESolution]?
```

Set the resolution bandwidth for the FFT. This is the bandwidth used for resolving the FFT measurement. It is not the pre-FFT bandwidth. This value is ignored if the function is auto-coupled.

Frequency span, resolution bandwidth, and the pre-FFT bandwidth settings are normally coupled. If you are not auto-coupled, there can be combinations of these settings that are not valid.

Factory Preset: 20.0 kHz

Range: 0.10 Hz to 3.0 MHz

Remarks: You must be in the Basic, cdmaOne, cdma2000, 1xEV-DO, W-CDMA, GSM, EDGE, NADC, or PDC mode to use this command. Use INSTRUMENT:SElect to set the mode.

### Spectrum—Resolution BW Auto

```
[ :SENSe ] :SPEctrum:BAWdwidth|BWIDth[:RESolution] :AUTO  
OFF|ON|0|1
```

```
[ :SENSe ] :SPEctrum:BAWdwidth|BWIDth[:RESolution] :AUTO?
```

Select auto or manual control of the resolution BW. The automatic mode couples the resolution bandwidth setting to the frequency span.

Factory Preset: ON

Remarks: You must be in the Basic, cdmaOne, cdma2000, W-CDMA, GSM, EDGE, NADC, or PDC mode to use this command. Use INSTRument:SElect to set the mode.

### Decimation of Spectrum Display

```
[ :SENSe ] :SPEctrum:DECimate[:FACTor] <integer>
```

```
[ :SENSe ] :SPEctrum:DECimate[:FACTor] ?
```

Sets the amount of data decimation done by the hardware and/or the software. Decimation by *n* keeps every *n*th sample, throwing away each of the remaining samples in the group of *n*. For example, decimation by 3 keeps every third sample, throwing away the two in between. Similarly, decimation by 5 keeps every fifth sample, throwing away the four in between.

Using zero (0) decimation selects the automatic mode. The measurement will then automatically choose decimation by “1” or “2” as is appropriate for the bandwidth being used.

This is an advanced control that normally does not need to be changed.

Factory Preset: 0

Range: 0 to 1,000, where 0 sets the function to automatic

Remarks: You must be in the Basic, cdmaOne, cdma2000, 1xEV-DO, W-CDMA, GSM, EDGE, NADC, or PDC mode to use this command. Use INSTRument:SElect to set the mode.

### Spectrum—FFT Length

```
[ :SENSe ] :SPEctrum:FFT:LENGth <integer>
```

```
[ :SENSe ] :SPEctrum:FFT:LENGth?
```

Set the FFT length. This value is only used if length control is set to manual. The value must be greater than or equal to the window length

value. Any amount greater than the window length is implemented by zero-padding. This is an advanced control that normally does not need to be changed.

Factory Preset: 706

Range: min, depends on the current setting of the spectrum window length  
max, 1,048,576

Remarks: You must be in the Basic, cdmaOne, cdma2000, 1xEV-DO, W-CDMA, GSM, EDGE, NADC, or PDC mode to use this command. Use INSTRUMENT:SElect to set the mode.

### Spectrum—FFT Length Auto

```
[ :SENSe ] :SPECTrum:FFT:LENGth:AUTO OFF | ON | 0 | 1
```

```
[ :SENSe ] :SPECTrum:FFT:LENGth:AUTO?
```

Select auto or manual control of the FFT and window lengths.

This is an advanced control that normally does not need to be changed.

On - the window lengths are coupled to resolution bandwidth, window type (FFT), pre-FFT bandwidth (sample rate) and SENSE:SPECTrum:FFT:RBWPoints.

Off - lets you set SENSE:SPECTrum:FFT:LENGth and SENSE:SPECTrum:FFT:WINDow:LENGth.

Factory Preset: ON

Remarks: You must be in the Basic, cdmaOne, cdma2000, 1xEV-DO, W-CDMA, GSM, EDGE, NADC, or PDC mode to use this command. Use INSTRUMENT:SElect to set the mode.

### Spectrum—FFT Minimum Points in Resolution BW

```
[ :SENSe ] :SPECTrum:FFT:RBWPoints <real>
```

```
[ :SENSe ] :SPECTrum:FFT:RBWPoints?
```

Set the minimum number of data points that will be used inside the resolution bandwidth. The value is ignored if length control is set to manual. This is an advanced control that normally does not need to be changed.

Factory Preset: 1.30

Range: 0.1 to 100

Remarks: You must be in the Basic, cdmaOne, cdma2000, 1xEV-DO, W-CDMA, GSM, EDGE, NADC, or PDC mode to use this command. Use INSTRument:SElect to set the mode.

### Spectrum—Window Delay

```
[ :SENSe ] :SPEctrum:FFT:WINDow:DELay <real>
```

```
[ :SENSe ] :SPEctrum:FFT:WINDow:DELay?
```

Set the FFT window delay to move the FFT window from its nominal position of being centered within the time capture. This function is not available from the front panel. It is an advanced control that normally does not need to be changed.

Factory Preset: 0

Range: -10.0 to +10.0s

Default Unit: seconds

Remarks: You must be in the Basic, cdmaOne, cdma2000, 1xEV-DO, W-CDMA, GSM, EDGE, NADC, or PDC mode to use this command. Use INSTRument:SElect to set the mode.

### Spectrum—Window Length

```
[ :SENSe ] :SPEctrum:FFT:WINDow:LENGth <integer>
```

```
[ :SENSe ] :SPEctrum:FFT:WINDow:LENGth?
```

Set the FFT window length. This value is only used if length control is set to manual. This is an advanced control that normally does not need to be changed.

Factory Preset: 706

Range: 8 to 1,048,576

Remarks: You must be in the Basic, cdmaOne, cdma2000, 1xEV-DO, W-CDMA, GSM, EDGE, NADC, or PDC mode to use this command. Use INSTRument:SElect to set the mode.

### Spectrum—FFT Window

```
[ :SENSe ] :SPEctrum:FFT:WINDow [ :TYPE ]
```

```
BH4Tap | BLACkman | FLATtop | GAUSSian | HAMMING | HANNing | KB70 | KB90 |  
KB110 | UNIFORM
```

**[ :SENSE ] :SPECTrum:FFT:WINDow [ :TYPE ] ?**

Select the FFT window type.

BH4Tap - Blackman Harris with 4 taps

BLACkman - Blackman

FLATtop - flat top, the default (for high amplitude accuracy)

GAUSSian - Gaussian with alpha of 3.5

HAMMing - Hamming

HANNing - Hanning

KB70, 90, and 110 - Kaiser Bessel with sidelobes at -70, -90, or -110 dBc

UNIFORM - no window is used. (This is the unity response.)

Factory Preset: FLATtop

Remarks: This selection affects the acquisition point quantity and the FFT size, based on the resolution bandwidth selected.

You must be in the Basic, cdmaOne, cdma2000, 1xEV-DO, W-CDMA, GSM, EDGE, NADC, or PDC mode to use this command. Use INSTRUMENT:SElect to set the mode.

### Spectrum—Frequency Span

**[ :SENSE ] :SPECTrum:FREQuency:SPAN <freq>**

**[ :SENSE ] :SPECTrum:FREQuency:SPAN?**

Set the frequency span to be measured.

Factory Preset: 1.0 MHz

Range: 10 Hz to 10.0 MHz (15 MHz when Service mode is selected)

Default Unit: Hz

Remarks: The actual measured span will generally be slightly wider due to the finite resolution of the FFT.

You must be in the Basic, cdmaOne, cdma2000, 1xEV-DO, W-CDMA, GSM, EDGE, NADC, or PDC mode to use this command. Use INSTRUMENT:SElect to set the mode.

### Spectrum—Sweep (Acquisition) Time

```
[ :SENSe ] :SPECTrum:SWEep:TIME[:VALue] <time>  
[ :SENSe ] :SPECTrum:SWEep:TIME?
```

Set the sweep (measurement acquisition) time. It is used to specify the length of the time capture record. If the value you specify is less than the capture time required for the specified span and resolution bandwidth, the value is ignored. The value is set at its auto value when auto is selected. This is an advanced control that normally does not need to be changed.

Factory Preset: 188.0  $\mu$ s

Range: 100 ns to 10 s

Default Unit: seconds

Remarks: You must be in the Basic, cdmaOne, cdma2000, 1xEV-DO, W-CDMA, GSM, EDGE, NADC, or PDC mode to use this command. Use INSTRument:SElect to set the mode.

### Spectrum—Sweep (Acquisition) Time Auto

```
[ :SENSe ] :SPECTrum:SWEep:TIME:AUTO OFF|ON|0|1  
[ :SENSe ] :SPECTrum:SWEep:TIME:AUTO
```

Select auto or manual control of the sweep (acquisition) time. This is an advanced control that normally does not need to be changed.

AUTO - couples the Sweep Time to the Frequency Span and Resolution BW

Manual - the Sweep Time is uncoupled from the Frequency Span and Resolution BW.

Factory Preset: AUTO

Remarks: You must be in the Basic, cdmaOne, cdma2000, 1xEV-DO, W-CDMA, GSM, EDGE, NADC, or PDC mode to use this command. Use INSTRument:SElect to set the mode.

### Spectrum—Trigger Source

```
[ :SENSe ] :SPECTrum:TRIGger:SOURce  
EXTernal [1] | EXTernal2 | FRAMe | IF | LINE | IMMEDIATE | RFBURSt  
[ :SENSe ] :SPECTrum:TRIGger:SOURce?
```

Select the trigger source used to control the data acquisitions.

EXTernal1 - front panel external trigger input

EXTernal2 - rear panel external trigger input

FRAMe - internal frame timer from front panel input

IF - internal IF envelope (video) trigger

LINE - internal line trigger

IMMEDIATE - the next data acquisition is immediately taken (also called free run)

RFBurst - wideband RF burst envelope trigger that has automatic level control for periodic burst signals

Factory Preset: IMMEDIATE (free run)

RFBurst, for GSM mode

Remarks: You must be in the Basic, cdmaOne, cdma2000, 1xEV-DO, W-CDMA, GSM, EDGE, NADC, or PDC mode to use this command. Use INSTRUMENT:SElect to set the mode.

## Waveform (Time-Domain) Measurement

Commands for querying the waveform measurement results and for setting to the default values are found in the “[MEASure Group of Commands](#)” on page 318. The equivalent front panel keys for the parameters described in the following commands, are found under the **Meas Setup** key, after the **Waveform (Time Domain)** measurement has been selected from the **MEASURE** key menu.

### Waveform—Data Acquisition Packing

```
[ :SENSe ] :WAVEform:ACQuistion:PACKing AUTO | LONG | MEDium | SHORT
```

```
[ :SENSe ] :WAVEform:ACQuistion:PACKing?
```

This is an advanced control that normally does not need to be changed.

Factory Preset: AUTO

Remarks: You must be in the Basic, cdmaOne, cdma2000, 1xEV-DO, W-CDMA, GSM, EDGE, NADC, or PDC mode to use this command. Use INSTRument:SElect to set the mode.

### Waveform—ADC Dither State

```
[ :SENSe ] :WAVEform:ADC:DITHer [ :STATe ] OFF | ON | 0 | 1
```

```
[ :SENSe ] :WAVEform:ADC:DITHer [ :STATe ] ?
```

This is an Advanced control that normally does not need to be changed.

Factory Preset: OFF

Remarks: You must be in the Basic, cdmaOne, cdma2000, 1xEV-DO, W-CDMA, GSM, EDGE, NADC, or PDC mode to use this command. Use INSTRument:SElect to set the mode.

### Waveform—Pre-ADC Bandpass Filter

```
[ :SENSe ] :WAVEform:ADC:FILTer [ :STATe ] OFF | ON | 0 | 1
```

```
[ :SENSe ] :WAVEform:ADC:FILTer [ :STATe ] ?
```

Turn the pre-ADC bandpass filter on or off. This is an Advanced control that normally does not need to be changed.

Preset: OFF

Remarks: You must be in the Basic, cdmaOne, cdma2000, 1xEV-DO, W-CDMA, GSM, EDGE, NADC, or PDC mode to use this command. Use INSTRument:SElect to



set the mode.

### Waveform—ADC Range

```
[ :SENSE ] :WAVEform:ADC:RANGe
AUTO | APEak | APLOCK | GROund | NONE | P0 | P6 | P12 | P18

[ :SENSE ] :WAVEform:ADC:RANGe?
```

Select the range for the gain-ranging that is done in front of the ADC. This is an Advanced control that normally does not need to be changed.

AUTO - automatic range

Auto Peak (APEak) - automatically peak the range

Auto Peak Lock (APLOCK)- automatically peak lock the range

GROund - ground

NONE - turn off auto-ranging without making any changes to the current setting.

P0 to P18 - adds 0 to 18 dB of fixed gain across the range

Factory Preset: AUTO

Remarks: You must be in the Basic, cdmaOne, cdma2000, 1xEV-DO, W-CDMA, GSM, EDGE, NADC, or PDC mode to use this command. Use INSTRUMENT:SElect to set the mode.

### Waveform - Query Aperture Setting

```
[ :SENSE ] :WAVEform:APERTure?
```

Returns the waveform sample period (aperture) based on current resolution bandwidth, filter type, and decimation factor. Sample rate is the reciprocal of period.

Remarks: You must be in the Basic, cdmaOne, cdma2000, 1xEV-DO, W-CDMA, GSM, EDGE, NADC, or PDC mode to use this command. Use INSTRUMENT:SElect to set the mode.

### Waveform—Number of Averages

```
[ :SENSE ] :WAVEform:AVERAge:COUNT <integer>

[ :SENSE ] :WAVEform:AVERAge:COUNT?
```

Set the number of sweeps that will be averaged. After the specified

number of sweeps (average counts), the averaging mode (terminal control) setting determines the averaging action.

Factory Preset: 10

Range: 1 to 10,000

Remarks: You must be in the Basic, cdmaOne, cdma2000, 1xEV-DO, W-CDMA, GSM, EDGE, NADC, or PDC mode to use this command. Use INSTRument:SElect to set the mode.

### Waveform—Averaging State

`[ :SENSe ] :WAVEform:AVERAge [ :STATe ] OFF | ON | 0 | 1`

`[ :SENSe ] :WAVEform:AVERAge [ :STATe ] ?`

Turn averaging on or off.

Factory Preset: OFF

Remarks: You must be in the Basic, cdmaOne, cdma2000, 1xEV-DO, W-CDMA, GSM, EDGE, NADC, or PDC mode to use this command. Use INSTRument:SElect to set the mode.

### Waveform—Averaging Mode

`[ :SENSe ] :WAVEform:AVERAge:TCONtrol EXPonential | REPeat`

`[ :SENSe ] :WAVEform:AVERAge:TCONtrol ?`

Select the type of termination control used for the averaging function. This determines the averaging action after the specified number of ‘sweeps’ (average count) is reached.

EXPonential - Each successive data acquisition after the average count is reached, is exponentially weighted and combined with the existing average.

REPeat - After reaching the average count, the averaging is reset and a new average is started.

Factory Preset: EXPonential

Remarks: You must be in the Basic, cdmaOne, cdma2000, 1xEV-DO, W-CDMA, GSM, EDGE, NADC, or PDC mode to use this command. Use INSTRument:SElect to set the mode.

### Waveform—Averaging Type

```
[ :SENSe] :WAVeform:AVERAge:TYPE
LOG | MAXimum | MINimum | RMS | SCALar
```

```
[ :SENSe] :WAVeform:AVERAge:TYPE?
```

Select the type of averaging.

LOG - The log of the power is averaged. (This is also known as video averaging.)

MAXimum - The maximum values are retained.

MINimum - The minimum values are retained.

RMS - The power is averaged, providing the rms of the voltage.

Factory Preset: RMS

Remarks: You must be in the Basic, cdmaOne, cdma2000, 1xEV-DO, W-CDMA, GSM, EDGE, NADC, or PDC mode to use this command. Use INSTRument:SElect to set the mode.

### Waveform—Resolution BW

```
[ :SENSe] :WAVeform:BANDwidth | BWIDth [:RESolution] <freq>
```

```
[ :SENSe] :WAVeform:BANDwidth | BWIDth [:RESolution] ?
```

Set the resolution bandwidth. This value is ignored if the function is auto-coupled.

Factory Preset: 100.0 kHz for NADC, PDC, cdma2000, W-CDMA, Basic  
500.0 kHz for GSM  
2.0 MHz for cdmaOne

Range: 1.0 kHz to 8.0 MHz when  
[:SENSe]:WAVeform:BANDwidth | BWIDth  
[:RESolution]:TYPE GAUSSian  
  
1.0 kHz to 10.0 MHz when  
[:SENSe]:WAVeform:BANDwidth | BWIDth  
[:RESolution]:TYPE FLATtop

Remarks: You must be in the Basic, cdmaOne, cdma2000, 1xEV-DO, W-CDMA, GSM, EDGE, NADC, or PDC mode to use this command. Use INSTRument:SElect to set the mode.

Bandwidths > 6.7 MHz will require a slight increase in measurement time.

### Waveform - Query Actual Resolution Bandwidth

`[ :SENSe ] :WAVEform :BANDwidth :RESolution ] :ACTual ?`

Due to memory constraints the actual resolution bandwidth value may vary from the value entered by the user. For most applications the resulting difference in value is inconsequential but for some it is necessary to know the actual value; this query retrieves the actual resolution bandwidth value.

Remarks: You must be in the Basic, cdmaOne, cdma2000, 1xEV-DO, W-CDMA, GSM, EDGE, NADC, or PDC mode to use this command. Use INSTRument:SElect to set the mode.

### Waveform—Resolution BW Filter Type

`[ :SENSe ] :WAVEform :BANDwidth | BWIDth [ :RESolution ] :TYPE  
FLATtop | GAUSSian`

`[ :SENSe ] :WAVEform :BANDwidth | BWIDth [ :RESolution ] :TYPE ?`

Select the type of Resolution BW filter that is used. This is an Advanced control that normally does not need to be changed.

FLATtop - a filter with a flat amplitude response, which provides the best amplitude accuracy.

GAUSSian - a filter with Gaussian characteristics, which provides the best pulse response.

Factory Preset: GAUSSian

Remarks: You must be in the Basic, cdmaOne, cdma2000, 1xEV-DO, W-CDMA, GSM, EDGE, NADC, or PDC mode to use this command. Use INSTRument:SElect to set the mode.

### Waveform—Decimation of Waveform Display

`[ :SENSe ] :WAVEform :DECimate [ :FACTor ] <integer>`

`[ :SENSe ] :WAVEform :DECimate [ :FACTor ] ?`

Set the amount of data decimation done on the IQ data stream. For example, if 4 is selected, three out of every four data points will be thrown away. So every 4th data point will be kept.

Factory Preset: 1

Range: 1 to 4

Remarks: You must be in the Basic, cdmaOne, cdma2000,

1xEV-DO, W-CDMA, GSM, EDGE, NADC, or PDC mode to use this command. Use INSTRUMENT:SElect to set the mode.

### Waveform—Control Decimation of Waveform Display

```
[ :SENSE ] :WAVEform:DECimate:STATE OFF | ON | 0 | 1
```

```
[ :SENSE ] :WAVEform:DECimate:STATE?
```

Set the amount of data decimation done by the hardware in order to decrease the number of acquired points in a long capture time. This is the amount of data that the measurement ignores.

Factory Preset: OFF

Remarks: You must be in the Basic, cdmaOne, cdma2000, 1xEV-DO, W-CDMA, GSM, EDGE, NADC, or PDC mode to use this command. Use INSTRUMENT:SElect to set the mode.

### Waveform—Sweep (Acquisition) Time

```
[ :SENSE ] :WAVEform:SWEep:TIME <time>
```

```
[ :SENSE ] :WAVEform:SWEep:TIME?
```

Set the measurement acquisition time. It is used to specify the length of the time capture record.

Factory Preset: 2.0 ms

10.0 ms, for NADC, PDC

Range: 1  $\mu$ s to 100 s

Default Unit: seconds

Remarks: You must be in the Basic, cdmaOne, cdma2000, 1xEV-DO, W-CDMA, GSM, EDGE, NADC, or PDC mode to use this command. Use INSTRUMENT:SElect to set the mode.

### Waveform—Trigger Source

```
[ :SENSE ] :WAVEform:TRIGger:SOURce EXTErnal [1] |  
EXTErnal2 | FRAME | IF | IMMEDIATE | LINE | RFBurst
```

```
[ :SENSE ] :WAVEform:TRIGger:SOURce?
```

Select the trigger source used to control the data acquisitions.

EXTernal 1 - front panel external trigger input

EXTernal 2 - rear panel external trigger input

FRAMe - internal frame timer from front panel input

IF - internal IF envelope (video) trigger

IMMEDIATE - the next data acquisition is immediately taken (also called free run)

LINE - internal line trigger

RFBurst - wideband RF burst envelope trigger that has automatic level control for periodic burst signals

Factory Preset: IMMEDIATE (free run), for Basic, cdmaOne, NADC, PDC mode

RFBurst, for GSM mode

Remarks: You must be in the Basic, cdmaOne, cdma2000, 1xEV-DO, W-CDMA, GSM, EDGE, NADC, or PDC mode to use this command. Use INSTRUMENT:SElect to set the mode.

## TRIGger Subsystem

The Trigger Subsystem is used to set the controls and parameters associated with triggering the data acquisitions. Other trigger-related commands are found in the INITiate and ABORt subsystems.

The trigger parameters are global within a selected Mode. The commands in the TRIGger subsystem set up the way the triggers function, but selection of the trigger source is made from each measurement. There is a separate trigger source command in the SENSE:<meas> subsystem for each measurement. The equivalent front panel keys for the parameters described in the following commands, can be found under the **Mode Setup, Trigger** key.

### Automatic Trigger Control

```
:TRIGger[:SEQuence]:AUTO:STATe OFF|ON|0|1
```

```
:TRIGger[:SEQuence]:AUTO:STATe?
```

Turns the automatic trigger function on and off. This function causes a trigger to occur if the designated time has elapsed and no trigger occurred. It can be used with unpredictable trigger sources, like external or burst, to make sure a measurement is initiated even if a trigger doesn't occur. Use TRIGger[:SEQuence]:AUTO[:TIME] to set the time limit.

Factory Preset

and \*RST Off for cdma2000, W-CDMA, NADC, PDC, 1xEV-DO

Front Panel

Access **Mode Setup, Trigger, Auto Trig**

### Automatic Trigger Time

```
:TRIGger[:SEQuence]:AUTO[:TIME] <time>
```

```
:TRIGger[:SEQuence]:AUTO[:TIME]?
```

After the measurement is activated the instrument will take a data acquisition immediately upon receiving a signal from the selected trigger source. If no trigger signal is received by the end of the time specified in this command, a data acquisition is taken anyway. TRIGger[:SEQuence]:AUTO:STATE must be on.

Factory Preset: 100.0 ms

Range: 1.0 ms to 1000.0 s

0.0 to 1000.0 s for cdma2000, W-CDMA, 1xEV-DO

Default Unit: seconds

## External Trigger Delay

```
:TRIGger [:SEQuence] :EXTErnal [1] | 2:DELAy <time>
```

```
:TRIGger [:SEQuence] :EXTErnal [1] | 2:DELAy?
```

Set the trigger delay when using an external trigger. Set the trigger value to zero (0) seconds to turn off the delay.

EXT or EXT1 is the front panel trigger input

EXT2 is the rear panel trigger input

Factory Preset: 0.0 s

Range: -100.0 ms to 100.0 ms  
-100.0 ms to 500.0 ms for 1xEV-DO

Default Unit: seconds

Front Panel

Access: **Mode Setup, Trigger, Ext Rear (or Ext Front), Delay**

## External Trigger Level

```
:TRIGger [:SEQuence] :EXTErnal [1] | 2:LEVEl <voltage>
```

```
:TRIGger [:SEQuence] :EXTErnal [1] | 2:LEVEl?
```

Set the trigger level when using an external trigger input.

EXT or EXT1 is the front panel trigger input

EXT2 is the rear panel trigger input

Factory Preset: 2.0 V

Range: -5.0 to +5.0 V

Default Unit: volts

Front Panel

Access: **Mode Setup, Trigger, Ext Rear, Level**  
**Mode Setup, Trigger, Ext Front, Level**

## External Trigger Slope

```
:TRIGger [:SEQuence] :EXTErnal [1] | 2:SLOPe NEGative|POSitive
```



**:TRIGger[:SEQuence]:EXTernal [1] | 2:SLOPe?**

Sets the trigger slope when using an external trigger input.

EXT or EXT1 is the front panel trigger input

EXT2 is the rear panel trigger input

Factory Preset: Positive

Front Panel

Access: **Mode Setup, Trigger, Ext Rear (or Ext Front), Slope**

## Frame Trigger Adjust

**:TRIGger[:SEQuence]:FRAMe:ADJust <time>**

Lets you advance the phase of the frame trigger by the specified amount. It does not change the period of the trigger waveform. If the command is sent multiple times, it advances the phase of the frame trigger more each time it is sent.

Factory Preset: 0.0 s

Range: 0.0 to 10.0 s

Default Unit: seconds

Front Panel

Access: None

## Frame Trigger Period

**:TRIGger[:SEQuence]:FRAMe:PERiod <time>**

**:TRIGger[:SEQuence]:FRAMe:PERiod?**

Set the frame period that you want when using the external frame timer trigger. If the traffic rate is changed, the value of the frame period is initialized to the preset value.

Factory Preset: 250.0  $\mu$ s for Basic, cdmaOne

4.615383 ms, for GSM

26.666667 ms for cdma2000 and 1xEV-DO

10.0 ms (1 radio frame) for W-CDMA

20.0 ms with rate=full for NADC, PDC

40.0 ms with rate=half for NADC, PDC

Range: 0.0 ms to 559.0 ms for Basic, cdmaOne, GSM, cdma2000, W-CDMA, 1xEV-DO

1.0 ms to 559.0 ms for NADC, PDC

Default Unit: seconds

Front Panel

Access: **Mode Setup, Trigger, Frame Timer, Period**

## Trigger Holdoff

**:TRIGger [:SEquence]:HOLDoff <time>**

**:TRIGger [:SEquence]:HOLDoff?**

Set the holdoff time between triggers. After a trigger, another trigger will not be allowed until the holdoff time expires. This parameter affects all trigger sources.

Factory Preset: 0.0 s

10.0 ms for NADC or PDC

Range: 0.0 to 500.0 ms

Default Unit: seconds

Front Panel

Access: **Mode Setup, Trigger, Trig Holdoff**

## Video (IF) Trigger Delay

**:TRIGger [:SEquence]:IF:DElay <time>**

**:TRIGger [:SEquence]:IF:DElay?**

Set the trigger delay when using the IF (video) trigger (after the Resolution BW filter).

Factory Preset: 0.0 s

Range: -100.0 ms to 500.0 ms

-100.0 ms to 100.0 ms for cdma2000, W-CDMA

Default Unit: seconds

Front Panel

Access: **Mode Setup, Trigger, Video (IF Envlp), Delay**

## Video (IF) Trigger Level

**:TRIGger [:SEquence]:IF:LEvel <ampl>**

**:TRIGger [:SEquence]:IF:LEvel?**

Set the trigger level when using the IF (video) trigger.

Factory Preset: -6.0 dBm for cdmaOne, GSM, EDGE, Basic,  
cdma2000, W-CDMA, 1xEV-DO

-30.0 dBm for NADC, PDC

Range: -200.0 to 50.0 dBm

Default Unit: dBm

Front Panel

Access: **Mode Setup, Trigger, Video (IF Envlp), Level**

## Video (IF) Trigger Slope

`:TRIGger[:SEquence]:IF:SLOPe NEGative|POSitive`

`:TRIGger[:SEquence]:IF:SLOPe?`

Sets the trigger slope when using the IF (video) trigger.

Factory Preset: Positive

Front Panel

Access: **Mode Setup, Trigger, Video (IF Envlp), Slope**

## RF Burst Trigger Delay

`:TRIGger[:SEquence]:RFBurst:DElay <time>`

`:TRIGger[:SEquence]:RFBurst:DElay?`

Set the trigger delay when using the RF burst (wideband) trigger.

Factory Preset: 0.0 s

Range: -100.0 ms to 500.0 ms

Default Unit: seconds

Front Panel

Access: **Mode Setup, Trigger, RF Burst, Delay**

## RF Burst Trigger Level

`:TRIGger[:SEquence]:RFBurst:LEVel <rel_power>`

`:TRIGger[:SEquence]:RFBurst:LEVel?`

Set the trigger level when using the RF Burst (wideband) Trigger. The value is relative to the peak of the signal. RF Burst is also known as RF

Envelope.

Factory Preset: -6.0 dB

Range: -25.0 to 0.0 dB  
-200.0 to 0.0 dB for NADC, PDC

Default Unit: dB

Front Panel

Access: **Mode Setup, Trigger, RF Burst, Peak Level**

## RF Burst Trigger Slope

`:TRIGger[:SEquence]:RFBurst:SLOPe NEGative|POSitive`

`:TRIGger[:SEquence]:RFBurst:SLOPe?`

Set the trigger slope when using the RF Burst (wideband) Trigger.

Factory Preset: Positive

Remarks: You must be in the cdmaOne, cdma2000, W-CDMA mode to use this command. Use `:INSTrument:SElect` to set the mode.

Front Panel

Access: **Mode Setup, Trigger, RF Burst, Slope**

## Numerics

- 1 Mohm balanced, 76
- 1 Mohm unbalanced, 76
- 1xEV-DO measurement, 423
- 50 ohm unbalanced, 76
- 600 ohm balanced, 76

## A

### ACP

- offset frequencies, 381
- offset sideband choice, 435
- setting amplitude levels, 380
- testing, 386, 435
- view of data, 299

### ACPR

- amplitude levels, 383, 385
- changing display, 143
- channel integration bandwidth, 138
- detector type, 388
- FFT sweep, 389
- measurement reference type, 140
- offset frequencies, 382
- offsets & limits, 138
- resolution bandwidths, 381
- spectrum graph
  - amplitude Y scale, 143
  - display, 144
- sweep mode detection, 388
- sweep time, 389
- sweep type, 389
- swept mode res BW, 388
- testing choices, 385, 390, 435
- view/trace selection, 141

### acpr

- bar graph (total power ref), 152
- sweep resolution bandwidth, 140
- sweep type
  - FFT, 140

### acquisition packing

- WAVeform, 472

### active license key, 118

- how to locate, 118

### Active Set Th (threshold) key

- Advanced menu, 175

### active set threshold

- CDP, 270
- modulation accuracy (rho), 294

### active set threshold mode

- CDP, 270
- modulation accuracy (rho), 295

### ADC calibration, 257

### ADC Dither key

- spectrum measurement, 217

### ADC dithering

### SPECTrum, 460

### WAVeform, 472

### ADC filter

- WAVeform, 472

### ADC range

- automatic control, 200
- automatic peak control, 200

### automatic peak lock, 201

### manual control, 201

### SPECTrum, 460

### WAVeform, 473

### ADC Range key

- spectrum measurement, 216

### ADC ranging function

- automatic control, 176, 191, 228
- automatic control to peak, 176, 191

### automatic lock to peak, 176, 191

### automatic peak control, 228

### automatic peak lock, 228

### manual control, 176, 191, 228

### adjacent channel power

- measurement, 378

### adjacent channel power ratio

- measurement, 322, 378

### See also ACPR

### Advanced menu

- Active Set Th (threshold) key, 175

### spectrum, 215

### waveform, 228

### advanced menu

- active set threshold, 191

### ADC dither, 229

### ADC range, 200

### ADC ranging function, 175, 191, 228

### chip rate, 175

### decimation, 229

### FFT window, 167

### number of data points, 133

### pre-ADC bandpass filter, 228

### resolution bandwidth, 133

### resolution bandwidth filter, 228

### sweep time, 133

### trigger source, 133

### alignment commands, 257

### amplitude

- input range, 414

- maximizing input signal, 414

### amplitude Y scale

- reference position, 134, 144, 149, 195, 196

- reference value, 133, 143, 149, 195

- scale coupling, 134, 144, 149, 195, 196

- scale per division, 133, 143, 149, 195

### applications

- currently available, 315

- applications, selecting, 315, 316

### ASCII data format, 310

### attenuation

- setting, 413

### average count

- intermodulation, 403

### averaging

- ACP, 378, 379

- ACPR, 378, 379

- CHPower, 394, 409, 410

- modulation accuracy (rho), 419

- OBW, 409

- QPSK EVM, 399

- SPECTrum, 461, 462, 463

- traces, 411

- transmit band spurs, 259, 261, 473

- WAVeform, 473, 474, 475

### averaging count

- spectrum emission mask, 423

### averaging state

- intermodulation, 403

- spectrum emission mask, 423

### averaging termination control

- intermodulation, 403

## B

### bandwidth

- ACPR, 379

- CHPower, 395

- occupied bandwidth, 410

- SPECTrum, 465, 466

- spectrum emission mask, 424

- WAVeform, 475, 476

### base code length, 299

### base frequencies delta

- intermodulation, 405

### base frequency auto search

- intermodulation, 405

### base lower frequency

- intermodulation, 406

### base station testing, 418

### base transmit station

- loss correction, 398

### base upper frequency

- intermodulation, 406

### Baseband I/Q inputs

- key access table, 256

- key entries, 256

- key path, 256

### Baseband IQ measurements, 239

### basic mode, 113

### binary data order, 310

- burst trigger
  - level, 483
- byte order of data, 310
- C**
- calibration
  - ADC, 257
- calibration commands, 257
- CCDF measurement, 349
- CDMA measurement, 341, 378, 391, 394, 419
- cdma2000
  - ACP measurement, 380
  - averaging, 399
  - offset frequencies, 428, 444, 445, 456
  - offset frequencies auto mode, 429, 430, 446
  - radio, 75
  - spectrum emission mask
    - measurement, 436, 437, 439, 441, 443, 450, 451, 453, 454, 455, 456
  - trigger source, 401, 421, 458
- cdma2000 measurement, 322, 342, 345, 348, 349, 351, 366, 378, 399, 403, 409, 415, 423
- cdmaOne
  - ACP measurement, 380, 386
  - trigger source, 421
- cdmaOne measurement, 322, 328, 351
- CDP
  - active set threshold, 270
  - active set threshold mode, 270
  - base code length, 299
  - computation type, 273
  - decode axis, 271
  - sweep offset, 271
  - sweep time, 272
  - Walsh code base length, 273
  - Walsh code length, 273
  - Walsh code number, 274
  - Walsh code order, 274
- CDPower
  - chip rate, 391
  - data capture time, 391
  - long code mask, 393
  - QOF, 392
  - quasi-orthogonal function, 392
  - selecting spectrum type, 392
  - sweep time, 392
  - trigger source, 393
- changing
  - instrument settings, 378
- channel power
  - advanced menu, 130
  - amplitude Y scale, 133
  - changing display, 133
  - channel bandwidth, 130
  - measurement setup, 132
  - power spectral density, 130
  - time record length, 130
- channel power measurement
  - See also CHPower
- channel power measurement, 341, 394
- chip rate
  - CDPower, 391
  - modulation accuracy (rho), 420
  - QPSK EVM, 400
- Choose Option key, 117
- CHPower
  - number of points, 396
  - sweep time, 396, 397
  - trigger source, 397
- code domain
  - code domain power graph
    - display, 179
    - base code length, 180
    - code order, 179, 180
    - bit reverse, 179, 180
    - Hadamard, 179, 180
    - consolidated marker, 180
  - code domain with quad view, 171
  - demodulated bit stream, 171
  - display, 179
    - chip dots, 179
  - I/Q error with quad view, 171
  - I/Q gain imbalance, 170
  - I/Q modulation impairments, 170
  - I/Q quadrature error, 170
  - in-channel characteristics, 170
  - marker function, 184
    - delta reading, 184
    - despread marker position, 185
    - marker function, 185
    - marker selection, 184
    - normal reading, 184
  - off, 185
  - shape selection, 185
  - trace with marker, 185
- marker functional markers off, 185
- measure control, 173
  - continuous, 173
  - measure, 173
  - single, 173
- measure setup, 173
  - advanced menu, 175
  - capture interval, 175
  - I/Q branch signals, 174
  - long code mask, 175
  - measure type, 174
  - measurement interval, 174
  - measurement offset, 174, 175
  - spectrum, 175
  - Walsh code number, 174
- measure setup Walsh code
  - length, 174
- next window, 176
- OVSF channels, 170
  - paging channel, 170
  - pilot channel, 170
  - sync channel, 170
  - traffic channel, 170
- power composite view, 170
- power graph & metrics, 171
- span X scale, 179
- symbol power graph
  - display, 180
  - composite chip power, 180
- view/trace, 176, 180, 194
  - code domain (quad view)
    - marker to de-spread, 179
  - code domain power graph, 181
    - amplitude Y scale, 181
    - span X scale, 181
    - symbol power graph span X scale, 181
  - code domain with quad view, 177
    - marker, 179
    - marker to

- de-spread, 179
  - demodulated bit stream view, 178
  - demodulated bits, 180, 194
    - demodulated bits window display, 180, 194
    - display, 180, 194
  - I/Q error graphs, 182
  - span X scale, 182
  - IQ error (quad view), 176
  - power graph & metrics, 176
  - width of channel, 170
  - zoom, 176
- code domain error limit
  - cdma2000, 295
  - modulation accuracy (rho), 295
  - W-CDMA (3GPP), 295
- code domain measurement
  - print setup, 184
  - using print function, 184
- code domain power graph
  - amplitude Y scale
    - reference value, 181
    - scale per division, 181
  - span X scale
    - expand, 181
    - reference position, 181
    - reference value, 181
    - scale per division, 181
  - symbol power graph
    - span X scale
      - reference position, 181, 182
      - scale coupling, 182
      - scale per division, 181
- code domain power measurement, 328, 391
  - See also CDPower
- code, programming
  - compatibility across PSA modes, 265, 267
  - compatibility, PSA series versus VSA, 268
- commands
  - compatibility across PSA modes, 265, 267
  - CONFigure, 319
  - FETCh, 320
  - MEASure, 318
  - PSA series versus VSA compatibility, 268
  - READ, 320, 321
  - compatibility, programming across PSA modes, 265
  - PSA series versus VSA, 268
  - CONFigure command use, 318
  - CONFigure commands, 319
  - continuous vs. single measurement mode, 312
  - control measurement commands, 312
  - correction
    - base transmit station loss, 398
    - mobile station loss, 398
  - current measurement, 298
  - curve fit the data, 275, 282
- D**
  - data
    - querying, 275, 282
  - data capture time
    - CDPower, 391
  - data decimation, 466
    - WAVeform, 476, 477
  - data format, 310
  - data from measurements, 318
  - Data Packing
    - spectrum measurement, 217, 229
  - Decimation
    - spectrum measurement, 217
  - decimation
    - SPEctrum, 466
  - decimation of data
    - WAVeform, 476, 477
  - default states, 74
  - default values, setting remotely, 319
  - deleting an application/personality, 114
  - delta markers, 287
  - demodulated bits window display
    - first page, 181, 194
    - last page, 181, 194
    - next page, 180, 194
    - previous page, 180, 194
    - scroll down, 180, 194
    - scroll up, 180, 194
  - diagnostic commands, 257
  - display
    - +45 degrees rotation, 194
    - absolute peak power levels & frequencies, 162
    - chip dots, 203
    - chip interval, 193
    - chip offset, 193
    - full vector background display, 194
    - I/Q points, 203
    - I/Q polar vector and/or constellation, 193
    - integrated power levels, 162
    - relative peak power levels & frequencies, 162
    - spectrum window, 258, 259, 301, 302, 307, 308
    - tiling, 299
    - trace, 302
    - window tile, 299
    - zoom, 300
  - display ACP data, 299
  - display commands, 299
  - display rho data, 300
  - dithering of ADC
    - WAVeform, 472
  - dithering the ADC, 460
- E**
  - external trigger
    - delay, 480
    - level, 480
    - slope, 481
- F**
  - fail conditions
    - absolute AND relative, 139
    - absolute level, 139
    - absolute OR relative, 139
    - relative level, 139
  - fail mask condition
    - absolute limit, 157, 159
    - absolute limit AND relative limit, 157, 159
    - absolute limit OR relative limit, 157, 159
    - relative limit, 157, 159
  - FETCh command use, 318
  - FETCh commands, 320
  - FFT
    - SPEctrum, 466, 467, 468, 469
  - FFT bandwidth, SPEctrum, 464, 465
  - FFT Length key, 216
  - FFT Size menu, 216
  - FFT window
    - Blackman filter, 168
    - Blackman-Harris filter, 168

- flat top filter, 168
- Gaussian filter with alpha 3.5, 168
- Hamming filter, 168
- Kaiser-Bessel 110 dB filter, 168
- Kaiser-Bessel 70 dB filter, 168
- Kaiser-Bessel 90 dB filter, 168
- occupied bandwidth, 410
- uniform filter, 168
- FFT Window key, 215
- format, data, 310
- frame trigger adjustment, 481
- frame trigger period, 481
- frequencies offset
  - ACP, 381
- frequency band limits
  - OBW, 293
- frequency channel, 83
  - center frequency, 83
  - center frequency step, 83
- frequency span
  - CHPower, 395
  - SPECTrum, 469
  - spectrum emission mask, 426
- FT window
  - Hanning filter, 168
- I**
- I and Q waveform view
  - I or Q waveform window, 221
  - I waveform window, 235
  - Q waveform window, 235
- I offset, 76
- I or Q waveform window
  - amplitude Y scale, 221
  - reference position, 222
  - reference value, 222
  - scale coupling, 222
  - scale per division, 222
  - span X scale, 221
    - reference position, 221, 233
    - reference value, 221, 233
    - scale coupling, 221, 233
    - scale per division, 221, 233
- I origin
  - I/Q polar window, 235, 236
- I Origin key, 222
- I waveform window
  - amplitude Y scale, 235
  - reference position, 235
  - scale coupling, 235
  - scale per division, 235
- I/Q data output, 113
- I/Q data results, 372, 375
- I/Q error (quad view)
  - phase error graph
    - amplitude Y scale, 195
- I/Q error graphs
  - EVM
    - amplitude Y scale, 183
    - reference position, 183
    - reference value, 183
    - scale coupling, 183
    - scale per division, 183
  - EVM graph
    - amplitude Y scale, 195
  - EVM or magnitude error graph
    - amplitude Y scale, 204
    - reference position, 204
    - reference value, 204
    - scale coupling, 204
    - scale per division, 204
  - magnitude error
    - amplitude Y scale, 183
    - reference position, 183
    - reference value, 183
    - scale coupling, 183
    - scale per division, 183
  - magnitude error graph
    - amplitude Y scale, 195
  - phase error
    - amplitude Y scale, 183
    - reference position, 184
    - reference value, 184
    - scale coupling, 184
    - scale per division, 183
- phase error graph
  - amplitude Y scale, 204
  - reference position, 205
  - reference value, 205
  - scale coupling, 205
  - scale per division, 205
- span X scale
  - reference position, 183, 194, 204
  - reference value, 183, 194, 204
  - scale coupling, 183, 195, 204
  - scale per division, 182, 194, 203
- I/Q input impedance, 76
- I/Q Polar view
  - waveform measurement, 235
- I/Q polar view
  - I/Q polar window, 222, 235
- I/Q polar window
  - amplitude Y scale, 222
  - I/Q scale per division, 222
  - Q Origin, 222
  - I origin, 235, 236
  - I/Q scale per division, 235
  - Q origin, 235, 236
  - span X scale, 222
    - I Origin, 222
- I/Q scale per division
  - I/Q polar window, 235
- I/Q Scale/Div key, 222
- I/Q setup, 76
- I/Q waveform view
  - I/Q waveform window, 235
- I/Q waveform window, 233
  - amplitude Y scale, 235
  - reference position, 235
  - reference value, 235
  - scale coupling, 235
  - scale per division, 235
- iDEN
  - ACP measurement, 380
  - trigger source, 411
- iDEN measurement, 348, 409
- iDEN offset frequencies, 381
- IF Flatness
  - advanced spectrum feature, 217
- IF trigger delay, 482
- IF trigger level, 482
- IF trigger slope, 483
- initiate measurement, 312, 313



- input
    - external attenuator, 78
    - attenuation for BTS tests, 78
    - attenuation for MS tests, 78
    - I/Q impedance reference for 1
      - Mohm input impedance, 76
    - IF alignment signal, 79
      - signal amplitude, 79
      - signal rate, 79
      - signal type, 79
    - input attenuator, 77, 78
    - input port, 75
      - 50 MHz reference, 76
      - Baseband Align Signal, 76
      - rf, 75
    - max total power, 77
    - maximum total power, 77
    - RF input range, 76
  - input attenuation, 413
  - input configuration, 259
  - input port
    - 50 MHz reference, 76
    - I only, 75
    - I/Q, 75
    - IF align, 76
    - Q only, 76
  - input port selection, 260, 402
  - input power
    - maximum, 414
    - range, 414
  - Install Now key, 117
  - installing measurement
    - personalities, 114
  - instrument configuration, 315
  - integration bandwidth
    - intermodulation, 404
  - intermodulation
    - amplitude Y scale, 149
    - average count, 403
    - averaging state, 403
    - averaging termination control, 403
    - base frequencies delta, 405
    - base frequency auto search, 405
    - base lower frequency, 406
    - base lower signal, 47
    - base upper frequency, 406
    - display, 149
      - IM products lines, 149
    - integration bandwidth, 404
    - intermodulation graph, 47
    - measure setup, 147
    - measurement mode, 407
    - measurement reference, 407
    - resolution bandwidth, 404
    - resolution bandwidth state, 405
    - span, 406
    - transmit IM, 147, 148, 154, 155
    - transmit intermodulation
      - products, 145
    - two-tone intermodulation
      - products, 145
      - view/trace, 148
  - intermodulation measurement, 345, 403
    - See also IM
  - internal reference selection, 260, 402
  - Internal RF Preamplifier, 78
  - IQ port selection, 260, 402
- K**
- key flow diagram
    - acpr, 85
    - channel power, 85
    - code domain, 85
    - intermodulation, 85
    - mode setup / frequency channel, 85
    - modulation accuracy (composite EVM), 85
    - occupied bandwidth, 85
    - power statistic CCDF, 85
    - QPSK EVM, 85
    - spectrum (frequency domain), 85
    - spectrum emission mask, 85
    - waveform (time domain), 85
- L**
- length
    - QPSK EVM, 401
  - Length Ctrl key, 216
  - Length key, 216
  - limit line testing, 275
  - limit testing
    - OBW, 293, 294
  - limits
    - fail mask condition, 157, 159
  - linear envelope view
    - linear envelope window, 234
    - phase window, 234
  - linear envelope window, 233
    - amplitude Y scale, 234
    - reference position, 234
    - reference value, 234
    - scale coupling, 234, 235
    - scale per division, 234
  - linear spectrum window
    - amplitude Y scale, 220
    - reference position, 221
    - reference value, 221
    - scale coupling, 221
    - scale per division, 220
- M**
- span, 220
  - loading an
    - application/personality, 114
  - long code mask
    - CDPower, 393
    - modulation accuracy (rho), 421

- measurement interval, 200, 209
- measurement mode, 147
  - automatic search mode, 147
  - transmit IM mode, 147
  - two-tone mode, 147
- number of counts, 209
- PN offset, 190
- reference channel
  - channel integration
    - bandwidth, 154
  - channel span, 154
  - resolution bandwidth, 154
  - step frequency, 154
- reference signal, 148
- resolution bandwidth, 148
  - automatic mode, 148
  - manual mode, 148
- spectrum, 190
- spectrum segment
  - offset, 155
- offsets and limits, 155
  - region, 155
- Walsh code quasi-orthogonal factor, 174
- measure type
  - absolute power, 174
  - relative power, 174
- measurement
  - adjacent channel power, 378
  - adjacent channel power ratio, 378
  - channel power, 130, 132, 394
  - code domain, 170, 172, 173
  - code domain power, 391
  - intermodulation, 403
  - intermodulation products, 145, 146
    - transmit intermodulation, 145
  - markers, 283
  - modulation accuracy (composite rho), 186
    - correlated power, 186
    - error vector magnitude, 186
    - frequency error, 187
    - I/Q origin offset, 187
    - magnitude error, 187
    - measure setup, 190
    - modulation quality, 186
    - number of active channels, 187
    - peak code domain error, 186
    - phase error, 187
    - rho, 186
    - time offset, 187
  - modulation accuracy (rho), 419
  - occupied bandwidth, 165, 167
  - measure setup, 167
  - spectrum shape, 165
  - transmitter operation, 165
- occupied BW, 409
- power stat CCDF
  - marker, 210
- power statistics CCDF, 207
  - display, 210
  - Gaussian distribution curve, 207
    - measure setup, 209
- power statistics CCDF measurement, 415
- QPSK error vector magnitude, 399
- QPSK EVM, 198
  - display, 203
  - I/Q error graphs
    - span X scale, 203
  - measure setup, 200
  - phase and frequency errors, 198
  - quadrature phase shift keying modulation, 198
  - view/trace, 201
- QPSK EVM phase trajectory, 198
- query current, 298
- spectrum
  - display, 222
  - spectrum (frequency domain), 460
  - spectrum emission mask, 151, 152, 423
  - spurious emissions and ACP, 423
  - waveform (time domain), 472
- measurement control
  - measure, 126
  - pause, 126
  - restart, 126
- measurement key flow, 85
- measurement mode
  - intermodulation, 407
- measurement modes
  - currently available, 315
  - selecting, 315, 316
- measurement reference
  - intermodulation, 407
- measurement reference type
  - power spectral density
    - reference, 160
  - spectral power density
    - reference, 140
  - total power reference, 140, 160
- measurement selection
- adjacent channel power ratio, 123, 124
- channel power, 123
- modulation accuracy (composite rho), 125
- power stat CCDF, 125
- QPSK EVM, 125
- spectrum (frequency domain), 125
- waveform (time domain), 126
- measurement setup
  - advanced menu, 133
  - averaging mode, 127
    - exponential, 127
  - averaging number, 127
  - averaging type, 127
    - log power average (video), 128
    - maximum voltage average, 128
    - minimum voltage average, 128
    - power average (rms), 128
    - voltage average, 128
  - channel power span, 132
  - integration bandwidth, 132
  - restore measurement defaults, 127
- measurements
  - adjacent channel power ratio, 322
  - CCDF, 349
  - channel power, 341
  - code domain power, 328
  - CONF/FETC/MEAS/READ commands, 318
  - control of, 312
  - getting results, 318
  - intermodulation, 345
  - modulation accuracy, 351
  - occupied BW, 348
  - power stat, 349
  - QPSK error vector magnitude, 342
  - setting default values remotely, 319
  - single/continuous, 312
  - spectrum (frequency domain), 259, 372
  - spectrum emission mask, 366
  - waveform (time domain), 260, 375
- measuring I/Q data, 372, 375
- Min Pts in RBW key, 216
- minimum value of trace data, 275, 282
- missing options, 114
- mobile station

- loss correction, 398
  - mobile station testing, 418
  - modulation accuracy (composite rho)
    - display, 193
    - I/Q error graphs
      - span X scale, 194
  - modulation accuracy (rho)
    - active set threshold, 294
    - active set threshold mode, 295
    - code domain error limit, 295
    - long code mask, 421
    - peak EVM limit, 295
    - phase error limit, 296
    - rho limit, 296
    - RMS EVM limit, 296
    - time offset limit, 296
  - modulation accuracy (rho) measurement, 419
    - See also RHO
  - modulation accuracy measurement, 351
  - multi carrier estimator
    - modulation accuracy (rho), 420
- N**
- NADC
    - offset frequencies, 381
  - NADC measurement, 378
  - normal marker, 287
- O**
- OBW
    - limit testing, 293, 294
    - trigger source, 411
  - OBW averaging, 409
  - occupied bandwidth
    - 99.0% bandwidth, 165
    - amplitude Y scale, 168
      - reference position, 168
      - reference value, 168
      - scale coupling, 168
      - scale per division, 168
    - FFT window, 410
    - measure setup
      - frequency span, 167
      - limit frequency value, 167
      - limit test, 167
      - resolution bandwidth, 167
    - view/trace, 168
  - occupied BW measurement, 348, 409
    - See also OBW
  - offset for pseudo-random noise, 271, 297
  - offset frequencies, 386
    - ACP, 381
    - spectrum emission mask, 428, 444, 445, 456
  - offset frequencies auto mode
    - spectrum emission mask, 429, 430, 446
  - offsets & limits
    - absolute limits, 139
    - fail conditions, 139
    - offset channel memory, 138
    - offset frequency, 138
    - offset side, 156
    - reference bandwidth, 139
    - relative attenuation, 156
    - relative limit (carrier level), 139
    - relative limit (PSD level), 140
  - offsets and limits
    - limits, 156
      - absolute start level, 156
      - absolute stop level, 156
      - relative start level, 156
      - relative stop level, 156, 157
    - measurement bandwidth, 156
    - offset, 155
    - resolution bandwidth, 156
    - start frequency, 155
    - step frequency, 156
    - stop frequency, 156
  - options
    - loading/deleting, 114
  - options not in instrument
    - memory, 114
- P**
- packing
    - SPECTrum, 460
  - pass/fail test, 275
  - PDC
    - offset frequencies, 381
    - trigger source, 411
  - PDC measurement, 348, 378, 409
  - peak EVM limit
    - cdma2000, 295
    - modulation accuracy (rho), 295
    - W-CDMA (3GPP), 295
  - personalities
    - currently available, 315
    - selecting, 315, 316
  - personality options not in instrument, 114
  - phase error limit
    - cdma2000, 296
    - modulation accuracy (rho), 296
  - phase inversion, 392
  - phase window, 233
    - amplitude Y scale, 234
    - reference position, 235
    - reference value, 234
  - scale per division, 234
  - points/measurement
    - CHPower, 396
  - power stat CCDF
    - display
      - Gaussian line display, 210
      - reference trace display, 210
      - store reference trace, 210
    - marker, 210
      - delta, 210
      - function, 210
      - marker all off, 210
      - normal, 210
      - off, 210
      - select, 210
      - shape, 210
      - trace, 210
    - span X scale, 210
      - scale per division, 210
  - power statistic CCDF
    - cdma2000, 294
    - store reference, 294
    - W-CDMA (3GPP), 294
  - power statistics CCDF
    - measurement, 415
    - See also PStat
  - pre-ADC bandpass filter
    - SPECTrum, 464
  - Pre-ADC BPF key
    - spectrum measurement, 215
  - Preamplifier
    - Setting the internal preamplifier, 78
  - pre-amplifier
    - attenuator, 413
    - on/off, 413
  - pre-FFT bandwidth, SPECTrum, 464, 465
  - Pre-FFT BW key, 215
  - Pre-FFT Fltr key, 215
  - preset states, 74
  - print setup
    - print demodulated bits data, 184
  - programming
    - compatibility among PSA modes, 265, 267
    - compatibility, PSA series versus VSA, 268
    - PSA series versus VSA (programming compatibility), 268
  - pseudo-random noise offset, 271, 297
- Q**
- Q offset, 76

- Q origin
  - I/Q Polar window, 235
  - I/Q polar window, 236
- Q Origin key, 222
- Q waveform window
  - amplitude Y scale, 235
  - reference position, 235
  - reference value, 235
  - scale coupling, 235
  - scale per division, 235
- QOF
  - CDPower, 392
- QPSK error vector magnitude
  - measurement, 342, 399
- QPSK error vector measurement
  - See also EVMQpsk
- QPSK EVM
  - averaging, 399
  - chip rate, 400
  - length, 401
  - RF carrier mode, 400
  - trigger source, 401
- quasi-orthogonal function
  - CDPower, 392
- query data, 275, 282
- R**
- radio
  - device, 75
- READ command use, 318
- READ commands, 320, 321
- real number data format, 310
- rear panel external trigger
  - delay, 480
  - slope, 481
- reference channel resolution
  - bandwidth
    - spectrum emission mask, 424
- reference channel resolution
  - bandwidth auto mode
    - spectrum emission mask, 425
- reference channel step frequency
  - spectrum emission mask, 426
- reference channel step frequency
  - auto mode list
    - spectrum emission mask, 427
- reference signal
  - automatic setting, 148
  - setting to the lower frequency, 148
  - setting to the upper frequency, 148
- reference, selecting internal, 260, 402
- region advanced menu
  - relative attenuation, 159
- regions and limits
  - limits, 159
    - absolute start level, 159
    - relative start level, 159
    - relative stop level, 159
  - limits absolute stop level, 159
  - limits absolute stop level, 159
  - region, 158
  - resolution bandwidth, 158
  - start frequency, 158
  - step frequency, 158
  - stop frequency, 158
- Res BW key
  - spectrum measurement, 215
  - waveform measurement, 228
- resolution bandwidth
  - intermodulation, 404
- resolution bandwidth state
  - intermodulation, 405
- restart measurement, 313
- results, waveform measurement, 225
- return data, 275, 282
- RF carrier mode
  - QPSK EVM, 400
- RF input port gain setting when
  - pre-amplifier is on, 413
- RF input port power gain, 413
- RF input, selection, 260, 402
- RHO
  - spectrum type, 421
  - view of data, 300
- rho limit
  - cdma2000, 296
  - modulation accuracy (rho), 296
  - W-CDMA (3GPP), 296
- RMS EVM limit
  - cdma2000, 296
  - modulation accuracy (rho), 296
  - W-CDMA (3GPP), 296
- RMS of trace data, 275, 282
- S**
- sampling trace data, 275, 282
- signal envelope view
  - signal envelope window, 233
- signal envelope window, 233
  - amplitude Y scale, 233
  - reference position, 234
  - reference value, 233
  - scale coupling, 234
  - scale per division, 233
- single vs. continuous
  - measurement mode, 312
- span
  - CHPower, 395
  - intermodulation, 406
  - SPECTrum, 469
- Span key
  - spectrum measurement, 215
- SPECTrum
  - acquisition packing, 460
  - ADC range, 460
  - data decimation, 466
  - FFT length, 466, 467
  - FFT resolution BW, 467
  - FFT window, 468, 469
  - FFT window delay, 468
  - frequency span, 469
  - sweep time, 470
  - trigger source, 470
- spectrum
  - all traces, 222
  - amplitude Y scale, 220
  - averaged trace, 222
  - changing the display, 220
  - changing views, 217
  - current trace, 222
  - I signal trace, 223
  - next window selection, 217
  - Q signal trace, 223
  - span X scale, 220
  - trace display, 222
  - view/trace, 217
  - zoom a window, 218
- Spectrum (Frequency Domain)
  - key, 212
- spectrum (frequency domain)
  - measurement, 259, 372, 460
  - See also SPECTrum
- spectrum emission mask
  - amplitude Y scale, 162
  - reference position, 162
  - reference value, 162
  - scale coupling, 162
  - scale per division, 162
- detector mode, 425
- display, 162
  - limit lines, 162
- measure setup, 154
  - detection type, 160
  - measurement interval, 154
  - measurement reference type, 160
  - reference channel, 154
  - spectrum segment, 155
  - region
    - regions and limits, 158
  - trigger source, 160
- measurement interval, 458
- offset start frequency, 430, 446

- offset stop frequency, [431](#), [433](#), [447](#), [449](#)
- offset stop frequency auto mode, [432](#), [448](#)
- power reference, [459](#)
- reference channel integration
  - bandwidth
  - method, [151](#)
- relative attenuation, [434](#), [449](#)
- setting amplitude levels, [436](#), [437](#), [439](#), [441](#), [443](#), [450](#), [451](#), [453](#), [454](#), [455](#), [456](#)
- spectral regrowth, [151](#)
- spurious emission, [151](#)
- testing choices, [438](#), [452](#)
- trigger source, [458](#)
- using markers, [163](#)
- view/trace, [161](#)
- spectrum emission mask
  - measurement, [366](#), [423](#)
  - See also SEM
- spectrum emission mask
  - offset frequencies, [428](#), [445](#)
  - offset frequencies auto mode, [429](#), [430](#), [446](#)
- spectrum graph display
  - reference bandwidth markers, [144](#)
- spectrum measurement
  - basic mode, [113](#)
  - making the measurement, [212](#)
  - method, [212](#)
  - results, [213](#)
- spectrum measurement display, [258](#), [259](#), [301](#), [302](#), [307](#), [308](#)
- spectrum phase
  - CDPower, [392](#)
- spectrum segment, [162](#)
- offset
  - view/trace, [161](#)
  - all offsets, [161](#)
  - offset A, [161](#)
  - offset E, [161](#)
  - offset side, [161](#)
- region
  - view/trace, [161](#)
  - all regions, [161](#)
  - region A, [161](#)
  - region E, [161](#)
- spectrum emission mask, [457](#)
- spectrum type
  - RHO, [421](#)
- spurious emissions and ACP measurement, [423](#)
- standard deviation of trace data, [275](#), [282](#)
- start measurement, [312](#), [313](#)
- state
  - changing, [378](#)
- store reference
  - power statistic CCDF, [294](#)
- sweep time
  - CDPower, [392](#)
  - SPECTrum, [470](#)
  - WAVEform, [477](#)
- Sweep Time key, [228](#)
- symbol power graph
  - amplitude Y scale
  - reference position, [182](#)
  - reference value, [182](#)
  - scale coupling, [182](#)
  - scale per division, [182](#)
- T**
- test limit
  - OBW, [293](#), [294](#)
- test limits, [275](#)
- tile the display, [299](#)
- time domain measurement, [260](#), [375](#), [472](#)
- time domain measurements, [225](#)
- time offset limit
  - cdma2000, [296](#)
  - modulation accuracy (rho), [296](#)
- trace averaging, [411](#)
- trace data
  - processing, [275](#), [282](#)
- trace display, [302](#)
- trace format, [310](#)
- trace names for markers, [288](#)
- trace/view selection
  - log envelope graph view, [229](#)
  - magnitude & phase graph view, [230](#)
- transmit band spurs - averaging
  - state, [259](#), [261](#), [473](#)
- trigger, [81](#)
  - auto time, [479](#)
  - automatic trigger, [81](#)
  - burst level, [483](#)
  - commands, [479](#)
  - delay, [81](#), [480](#)
  - delay, IF, [482](#)
  - external, [480](#), [481](#)
  - external front input, [81](#)
  - external rear input, [81](#)
  - frame adjustment, [481](#)
  - frame period, [481](#)
  - frame timer, [82](#)
  - offset, [82](#)
  - period, [82](#)
- reset offset display, [82](#)
- synchronizing source, [82](#)
- holdoff, [482](#)
- level, [81](#), [480](#)
- level, IF, [482](#)
- on/off, [479](#)
- RF burst signal, [81](#)
- slope, [81](#), [481](#)
- slope, IF, [483](#)
- SPECTrum, [470](#)
- timeout, [479](#)
- trigger holdoff, [81](#)
- trigger source, [128](#)
  - external front input, [128](#)
  - external rear input, [128](#)
  - frame clock, [129](#)
  - free run (immediate), [128](#)
  - line, [129](#)
  - RF burst (wideband), [128](#)
  - video (IF envelope), [128](#)
  - video (envelope) signal, [81](#)
  - WAVEform, [477](#)
- trigger measurement, [312](#), [313](#)
- trigger source
  - cdma2000, [393](#)
  - OBW, [411](#)
  - QPSK EVM, [401](#)
  - Rho, [421](#)
  - spectrum emission mask, [458](#)
  - W-CDMA, [393](#)
- triggering
  - CHPower, [397](#)
- U**
- Uninstall Now, [118](#), [119](#)
- uninstalling measurement personalities, [114](#)
- V**
- view ACP data, [299](#)
- view commands, [299](#)
- view rh data, [300](#)
- view/trace
  - I/Q error with quad view, [192](#), [202](#)
  - I/Q measured polar constellation, [201](#)
  - I/Q measured polar vector, [201](#)
  - I/Q measured polar vector graph, [192](#)
  - I/Q waveforms, [219](#)
  - linear spectrum and phase graphs, [218](#)
  - spectrum graph, [218](#)
  - view/trace selection
    - I and Q Waveform view, [231](#)
    - I and Q waveform view, [221](#)

- I/Q polar waveform view, [232](#)
- I/Q waveform graph window, [219](#)
- I/Q Waveform view, [231](#)
- linear envelope and phase view, [230](#)
- magnitude & phase graph view, [218](#)
- spectrum linear
  - linear spectrum window, [220](#)
- VSA versus PSA series (programming compatibility), [268](#)
- W**
- WAVEform
  - acquisition packing, [472](#)
  - ADC dithering, [472](#)
  - ADC filter, [472](#)
  - ADC range, [473](#)
  - data decimation, [476](#), [477](#)
  - sweep time, [477](#)
  - trigger source, [477](#)
- waveform
  - advanced menu, [228](#)
  - changing displays, [233](#)
  - changing views, [229](#)
    - view/trace selection, [229](#)
  - I and Q waveform view, [235](#)
  - I/Q waveform view, [235](#)
  - linear envelope view, [234](#)
  - making the measurement, [225](#)
  - method, [225](#)
  - next window selection, [229](#)
  - resolution bandwidth, [228](#)
  - results, [226](#)
  - span X scale, [233](#)
  - sweep time, [228](#), [233](#)
  - using markers, [149](#), [236](#)
  - zoom a window, [229](#)
- Waveform (Time Domain) key, [225](#)
- waveform (time domain)
  - measurement, [260](#), [375](#), [472](#)
  - See also WAVEform
- waveform measurement
  - basic mode, [113](#)
  - display, [236](#)
  - I/Q Polar view, [235](#)
- W-CDMA
  - ACP measurement, [380](#)
  - trigger source, [421](#)
- W-CDMA (3GPP)
  - averaging, [399](#)
  - offset frequencies, [428](#), [444](#), [445](#), [456](#)
  - offset frequencies auto mode, [429](#), [430](#), [446](#)
  - spectrum emission mask
    - measurement, [436](#), [437](#), [439](#), [441](#), [443](#), [450](#), [451](#), [453](#), [454](#), [455](#), [456](#)
  - trigger source, [401](#), [458](#)
- W-CDMA (3GPP) measurement, [322](#), [328](#), [342](#), [345](#), [348](#), [349](#), [351](#), [366](#), [399](#), [403](#), [409](#), [415](#), [423](#)
- W-CDMA (Trial & ARIB)
  - averaging, [399](#)
  - trigger source, [401](#)
- W-CDMA (Trial & ARIB) measurement, [322](#), [328](#), [342](#), [349](#), [351](#), [399](#), [415](#)
- W-CDMA measurement, [378](#)
- Window Length key, [216](#)
- Z**
- zero span measurement, [260](#), [375](#), [472](#)
- zoom the display, [300](#)